

Features

- Planar Die Construction
- 350mW Power Dissipation
- Zener Voltages from 43V - 51V
- Ideally Suited for Automated Assembly Processes
- Lead, Halogen and Antimony Free, RoHS Compliant "Green" Device (Notes 3 and 6)**

Mechanical Data

- Case: SOT-23
- Case Material: Molded Plastic. UL Flammability Classification Rating 94V-0
- Moisture Sensitivity: Level 1 per J-STD-020D
- Terminals: Solderable per MIL-STD-202, Method 208
- Lead Free Plating (Matte Tin Finish annealed over Alloy 42 leadframe).
- Polarity: See Diagram
- Marking Information: See Page 2
- Ordering Information: See Page 2
- Weight: 0.008 grams (approximate)



Top View

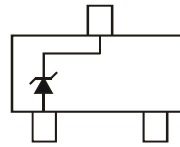

Device Schematic

Maximum Ratings @ $T_A = 25^\circ\text{C}$ unless otherwise specified

Characteristic	Symbol	Value	Unit
Forward Voltage @ $I_F = 10\text{mA}$	V_F	0.9	V

Thermal Characteristics

Characteristic	Symbol	Value	Unit
Power Dissipation (Note 1)	P_D	300	mW
Power Dissipation (Note 2)	P_D	350	mW
Thermal Resistance, Junction to Ambient Air (Note 1)	$R_{\theta JA}$	417	$^\circ\text{C/W}$
Thermal Resistance, Junction to Ambient Air (Note 2)	$R_{\theta JA}$	357	$^\circ\text{C/W}$
Operating and Storage Temperature Range	T_J, T_{STG}	-65 to +150	$^\circ\text{C}$

Electrical Characteristics @ $T_A = 25^\circ\text{C}$ unless otherwise specified

Type Number	Type Code	Zener Voltage Range (Note 5)				Maximum Zener Impedance (Note 4)			Maximum Reverse Current (Note 5)		Typical Temperature Coefficient @ I_{ZT} mV/ $^\circ\text{C}$	
		$V_Z @ I_{ZT}$			I_{ZT} (mA)	$Z_{ZT} @ I_{ZT}$ (Ω)	$Z_{ZK} @ I_{ZK}$		I_R (μA)	V_R (V)	Min	Max
		Nom (V)	Min (V)	Max (V)			(Ω)	(mA)				
BZX84C43	Y15/KYF	43	40.0	46.0	2.0	150	375	0.5	0.1	30.1	10.0	12.0
BZX84C47	Y16/KYG	47	44.0	50.0	2.0	170	375	0.5	0.1	32.9	10.0	12.0
BZX84C51	Y17/KYH	51	48.0	54.0	2.0	180	400	0.5	0.1	35.7	10.0	12.0

- Notes:
- Device mounted on FR-4 PC board with recommended pad layout, which can be found on our website at <http://www.diodes.com/datasheets/ap02001.pdf>.
 - Valid provided the terminals are kept at ambient temperature.
 - No purposefully added lead. Halogen and Antimony Free.
 - $f = 1\text{KHz}$.
 - Short duration pulse test used to minimize self-heating effect.
 - Product manufactured with Data Code V9 (week 33, 2008) and newer are built with Green Molding Compound. Product manufactured prior to Date Code V9 are built with Non-Green Molding Compound and may contain Halogens or Sb_2O_3 Fire Retardants.

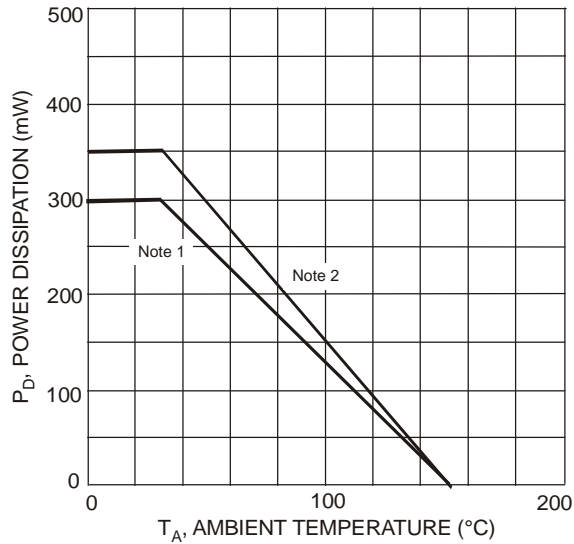

Fig. 1 Power Derating Curve

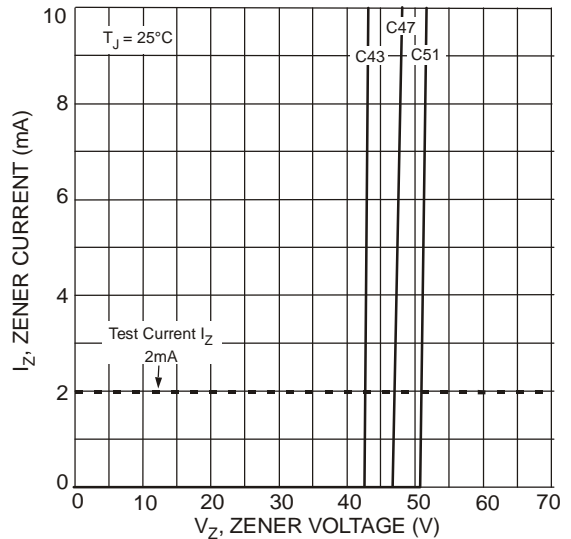

Fig. 2 Typical Zener Breakdown Characteristics

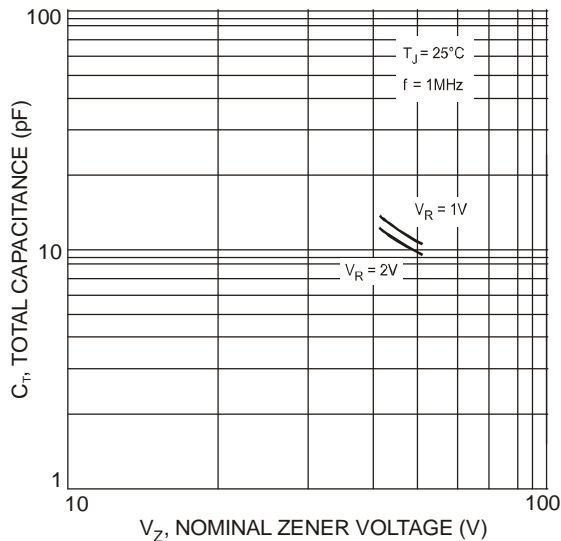

Fig. 3 Typical Total Capacitance vs. Nominal Zener Voltage

Ordering Information (Note 7)

Part Number	Case	Packaging
(Type Number)-7-F*	SOT-23	3000/Tape & Reel

*Add "-7" to the appropriate type number in Electrical Characteristics Table on Page 2. Example: 43V Zener = BZX84C43-7-F.

Notes: 7. For packaging details, go to our website at <http://www.diodes.com/datasheets/ap02007.pdf>.

Marking Information

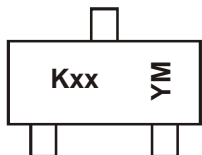

Kxx = Product Type Marking Code (See Electrical Characteristics Table)
 YM = Date Code Marking
 Y = Year ex: T = 2006
 M = Month (ex: 9 = September)

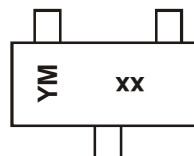

xx = Product Type Marking Code (See Electrical Characteristics Table)
 YM = Date Code Marking
 Y = Year ex: T = 2006
 M = Month (ex: 9 = September)

Date Code Key

Year	2006	2007	2008	2009	2010	2011	2012	2013	2014	2015
Code	T	U	V	W	X	Y	Z	A	B	C

Month	Jan	Feb	Mar	Apr	May	Jun	Jul	Aug	Sep	Oct	Nov	Dec
Code	1	2	3	4	5	6	7	8	9	O	N	D

Package Outline Dimensions

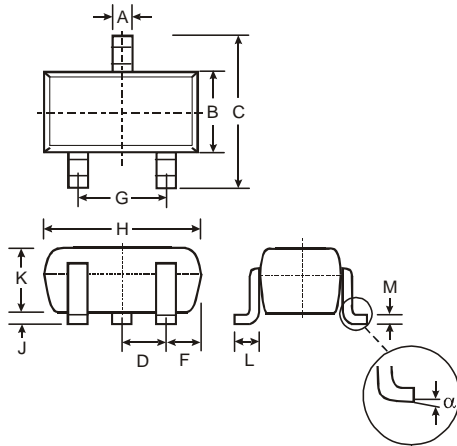

SOT-23		
Dim	Min	Max
A	0.37	0.51
B	1.20	1.40
C	2.30	2.50
D	0.89	1.03
F	0.45	0.60
G	1.78	2.05
H	2.80	3.00
J	0.013	0.10
K	0.903	1.10
L	0.45	0.61
M	0.085	0.180
α	0°	8°

Suggested Pad Layout

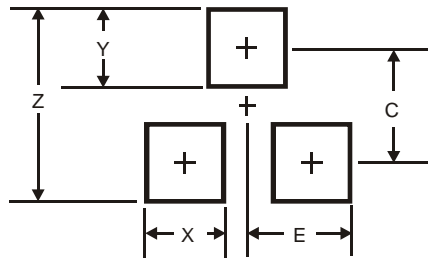

Dimensions	Value (in mm)
Z	2.9
X	0.8
Y	0.9
C	2.0
E	1.35

IMPORTANT NOTICE

Diodes Incorporated and its subsidiaries reserve the right to make modifications, enhancements, improvements, corrections or other changes without further notice to any product herein. Diodes Incorporated does not assume any liability arising out of the application or use of any product described herein; neither does it convey any license under its patent rights, nor the rights of others. The user of products in such applications shall assume all risks of such use and will agree to hold Diodes Incorporated and all the companies whose products are represented on our website, harmless against all damages.

LIFE SUPPORT

Diodes Incorporated products are not authorized for use as critical components in life support devices or systems without the expressed written approval of the President of Diodes Incorporated.