



## Designing Better, Simpler Audio Solutions with Dynamic Range Enhancement (DRE)

*By Matt Felder, Distinguished Member of the Technical Staff, IC Design,  
Mobile Audio, Maxim Integrated*

**March 2018**

## Abstract

Integrating high-fidelity sound into a variety of applications is challenging in terms of audio quality. An ideal digital-input analog-output signal path would implement a gain control method that would allow the audio quality advantages of an output analog gain without the complications and limitations of the analog gain. This paper explains how ICs built to enhance dynamic range can simplify audio solution design while yielding higher performing audio applications.



*Deliver rich  
sound with  
dynamic range  
enhancement*

## Introduction

Even the smallest speakers are expected to have big, bold sound. From portable laptop speakers to voice-controlled smart home speakers, these devices desire far-ranging, high-fidelity sound in a compact form factor.

Engineers now have the ability to more easily integrate sound into a wider range of products—including many that never had sound before. While this opens up new market opportunities, it also presents new design challenges related to dynamic range and the noise floor. In this paper, we'll take a look at easy-to-use technology that enhances audio amplifiers with these performance advantages:

- Improved dynamic range and noise floor
- Improved power-supply rejection ratio (PSRR)
- Lower power consumption for given noise floor performance
- Simplified and improved signal path gain control (digital rather than analog)
- System-level simplification by allowing digital volume control at the source

## A Look at the Digital-Input Analog-Output Signal Path

A typical digital-input analog-output signal path will have a digital gain control near the input and an analog gain control near the output of the signal path (see Figure 1). In most cases the best signal quality is achieved by maximizing the digital signal (maximizing dynamic range) and using the lowest possible gain at the analog output (at the end of the path). Using the lowest gain in the output stage results in the lowest noise as it attenuates all of the analog noise sources in the path. Lower output gain usually has other side benefits, including improved power-supply rejection.

When given the option of controlling the output signal level with a digital gain or an analog gain, it has almost always been preferable to control the level with the analog gain to get the best signal quality (noise and PSRR, especially). However, analog gains usually come with troublesome limitations. First, due to random component mismatch and parasitic impedances, analog gain is often not as accurate as digital gain. Second, analog gain is usually range-limited to around 60dB before parasitic impedances start to make the gain step error too large.

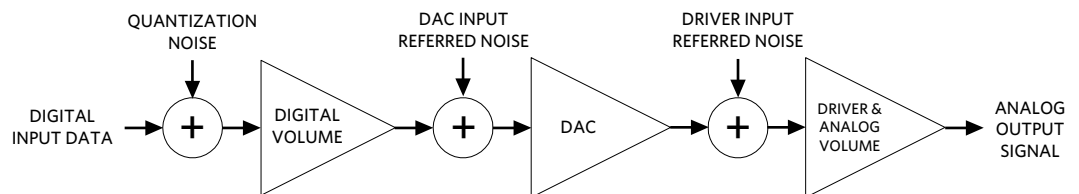

Figure 1. Typical digital-input analog-output signal path

By contrast, digital gain can potentially implement very small gain steps and very wide gain range. Third, changing analog gains usually causes a change in the output DC offset, which can result in a signal pop. A digital gain step will normally not cause a shift in the output offset. Finally, digital gains can optionally be performed back in the source of the digital input, which can be a simplification advantage in some system designs.

An ideal signal path would implement a gain control method that would allow the audio quality advantages of an output analog gain without the complications and limitations of the analog gain. The dynamic range enhancement (DRE) technique does just this.

## Maximizing Dynamic Range

The DRE circuit maximizes the dynamic range by monitoring the digital input data and automatically adjusting two complimentary gains in the path to keep the overall path gain unchanged (see Figure 2). At a low digital input signal level, the input digital gain is increased

and the output analog gain is decreased by an equivalent amount. At the maximum digital input signal level, no gain is added to the digital and no gain change is made on the analog output. As mentioned earlier, when analog gains are changed, it can potentially cause a DC offset shift in the output. The DRE circuit incorporates multiple proprietary techniques to avoid degradation in the signal path during these internal gain transitions.

As DRE is activated (at lower signal levels), almost all noise sources in the signal path are attenuated. The only noise source that doesn't get attenuated is the digital input quantization noise. That noise is left alone as it is gained up by the digital gain stage and attenuated back to the input level by the analog output stage.

The DRE gain controls shown in the diagram above keep the path gain at a fixed level while maximizing the dynamic range. Now we need to add a path gain control signal to the system to set the output signal level. This gain could potentially be done in either the digital or analog volume. With DRE technology in place, there is no longer a performance

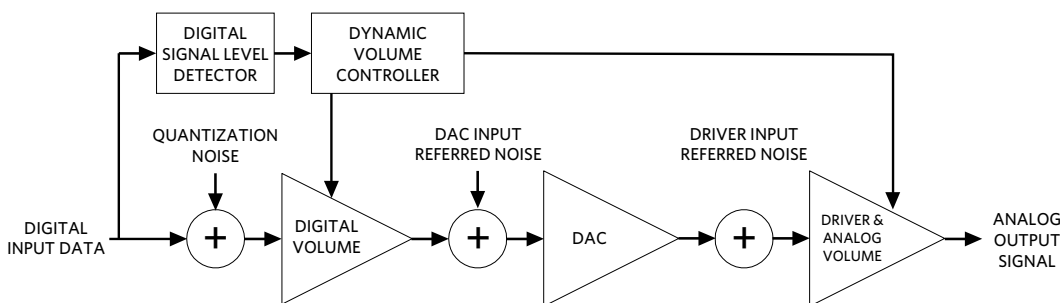

Figure 2. DRE circuit maximizes dynamic range

advantage to using analog volume. Instead, we can use a simple digital volume control that can exist either back at the source of the digital input data or in the same digital volume block used by the DRE circuit.

In many cases, the input data source has a much lower quantization noise level than the analog noise sources of the signal path. In these cases, it won't matter that the quantization noise isn't getting attenuated by DRE. However, in a case like a 16-bit audio data stream, it is possible that the quantization noise is the limiting noise in the system. In this case, it would be preferable if the quantization noise could be reduced with the output signal level. If the path gain control only occurred on the 16-bit digital data stream, we would lose signal without reducing the noise. However, this problem can be avoided by extending the input digital data from 16bits to 24bits prior to attenuating the digital signal. The source data is still 16-bits, and now the signal level can be digitally attenuated without losing the LSB input data and hurting the dynamic range of the path.

## Plug-and-Play Audio Amplifier

DRE technology (patent number 8,362,936) is available in the Maxim MAX98357 digital pulse-code modulation (PCM) input Class D audio power amplifier. A tiny, plug-and-play solution, the MAX98357 provides Class AB audio performance with Class D efficiency.

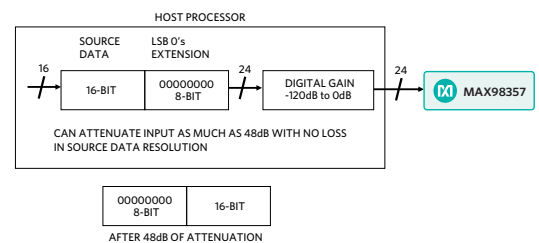

*Figure 3. Using LSB extension to add digital gain without losing dynamic range*

Figure 3 demonstrates how least significant bit (LSB) extension can be used to allow digital gain to be added to 16bit input data to create 24bit I2S output data for the MAX98357 that loses no dynamic range.

Configuration	16-Bit Input Data	>20-Bit Input Data
1. Analog Gain without DRE	98.2dB	103dB
2. Digital Gain without DRE	95.2dB	97dB
3. Digital Gain with DRE	98.2dB	103dB

Notes:

- 1) All results include A-weighting
- 2) An A-weighted 16-bit input sinusoid has a dynamic range of 100.3dB

*Table 1: Comparing dynamic range performance for three different system configurations.*

### ANALOG GAIN WITHOUT DRE

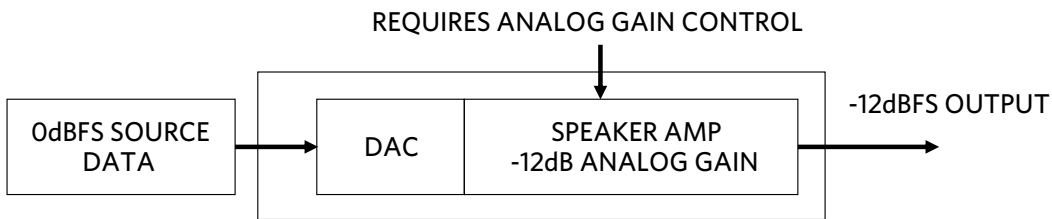

Figure 4. Analog gain without DRE

### DIGITAL GAIN WITHOUT DRE

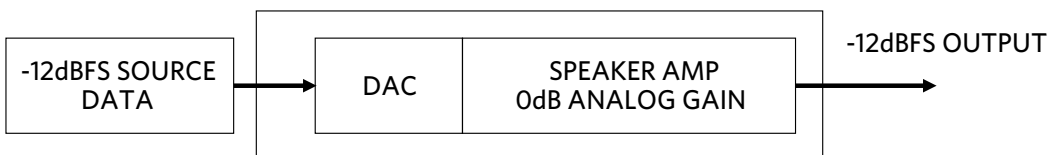

Figure 5. Digital gain without DRE

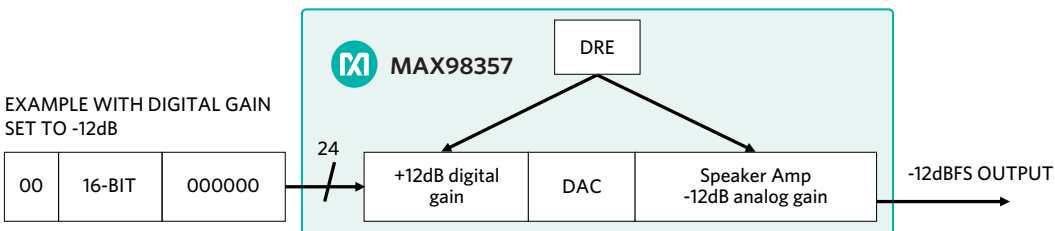

Figure 6. Digital gain with DRE

Figures 4, 5, and 6 compare the dynamic range performance for three different system configurations. Each of these three systems will use the same DAC and speaker amplifier, which have an analog noise floor of -103dBFS at -12dB gain and -97dBFS at 0dB gain, respectively. The results (in Table 1) show that for this system, DRE can provide a 3dB improvement with 16bit data or a 6dB improvement with 20bit data.

The MAX98357 doesn't have a mode to allow DRE to be disabled. The plot shown in Figure 7 is from another Maxim audio chip that does allow DRE to be disabled.

This plot shows the THD+N versus signal level for different gain settings, both with and without DRE enabled. As explained in this paper, DRE allows the noise floor to stay at its minimal level regardless of the gain setting.

Notice that as the output voltage scales up, the DRE-enabled plot will move from following the +3dB trace, to the +6dB trace, then +9dB trace, all the way up to the +18dB trace at a high enough output level.



MAX98357  
supports I2S  
and 8-channel  
TDM data

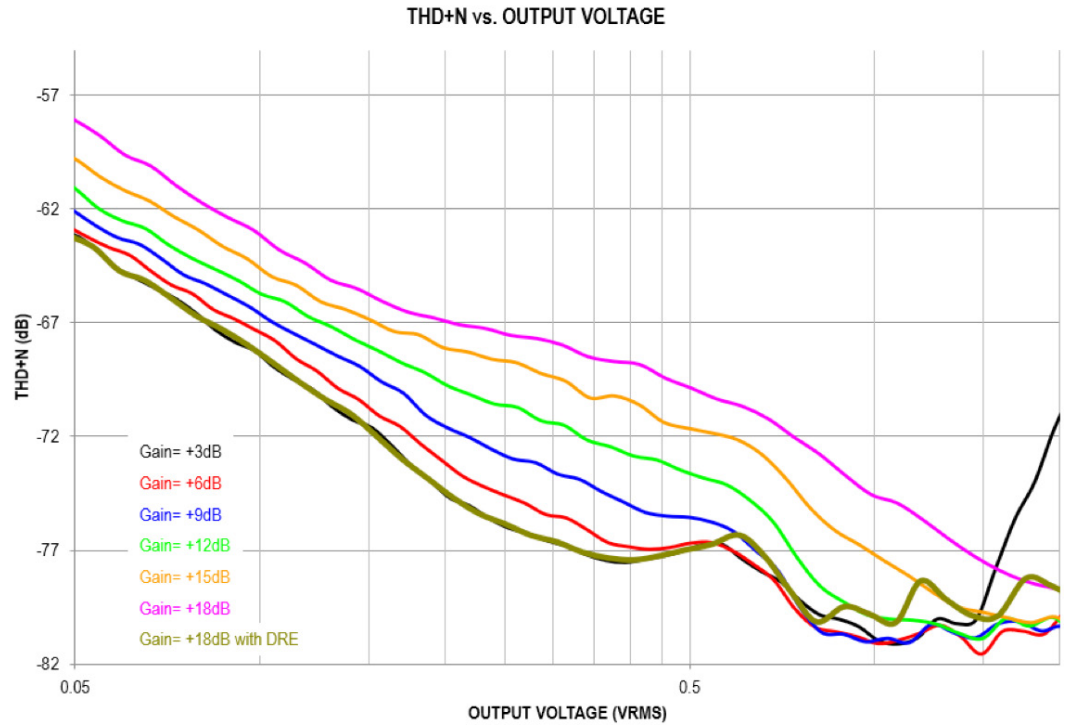

Figure 7. THD+N versus signal level for different gain settings, both with and without DRE enabled

## Summary

Delivering rich audio quality for a variety of applications—especially portable devices—can be a challenge. This paper examined how ICs built to enhance dynamic range can simplify audio solution design while yielding higher performing audio applications.

## For More Information

Learn more about these audio ICs with DRE:

- [MAX98357](#)
- [MAX98372](#)

### Learn more

For more information, visit:  
[www.maximintegrated.com](http://www.maximintegrated.com)