

ON Semiconductor

Is Now

onsemi™

To learn more about onsemi™, please visit our website at
www.onsemi.com

onsemi and **onsemi** and other names, marks, and brands are registered and/or common law trademarks of Semiconductor Components Industries, LLC dba "**onsemi**" or its affiliates and/or subsidiaries in the United States and/or other countries. **onsemi** owns the rights to a number of patents, trademarks, copyrights, trade secrets, and other intellectual property. A listing of **onsemi** product/patent coverage may be accessed at www.onsemi.com/site/pdf/Patent-Marking.pdf. **onsemi** reserves the right to make changes at any time to any products or information herein, without notice. The information herein is provided "as-is" and **onsemi** makes no warranty, representation or guarantee regarding the accuracy of the information, product features, availability, functionality, or suitability of its products for any particular purpose, nor does **onsemi** assume any liability arising out of the application or use of any product or circuit, and specifically disclaims any and all liability, including without limitation special, consequential or incidental damages. Buyer is responsible for its products and applications using **onsemi** products, including compliance with all laws, regulations and safety requirements or standards, regardless of any support or applications information provided by **onsemi**. "Typical" parameters which may be provided in **onsemi** data sheets and/or specifications can and do vary in different applications and actual performance may vary over time. All operating parameters, including "Typicals" must be validated for each customer application by customer's technical experts. **onsemi** does not convey any license under any of its intellectual property rights nor the rights of others. **onsemi** products are not designed, intended, or authorized for use as a critical component in life support systems or any FDA Class 3 medical devices or medical devices with a same or similar classification in a foreign jurisdiction or any devices intended for implantation in the human body. Should Buyer purchase or use **onsemi** products for any such unintended or unauthorized application, Buyer shall indemnify and hold **onsemi** and its officers, employees, subsidiaries, affiliates, and distributors harmless against all claims, costs, damages, and expenses, and reasonable attorney fees arising out of, directly or indirectly, any claim of personal injury or death associated with such unintended or unauthorized use, even if such claim alleges that **onsemi** was negligent regarding the design or manufacture of the part. **onsemi** is an Equal Opportunity/Affirmative Action Employer. This literature is subject to all applicable copyright laws and is not for resale in any manner. Other names and brands may be claimed as the property of others.



FDP4D5N10C / FDPF4D5N10C

N-Channel Shielded Gate PowerTrench® MOSFET

100 V, 128 A, 4.5 mΩ

Features

- Max $r_{DS(on)}$ = 4.5 mΩ at $V_{GS} = 10$ V, $I_D = 100$ A
- Extremely Low Reverse Recovery Charge, Q_{rr}
- 100% UIL Tested
- RoHS Compliant



General Description

This N-Channel MV MOSFET is produced using ON Semiconductor's advanced PowerTrench® process that incorporates Shielded Gate technology. This process has been optimized to minimize on-state resistance and yet maintain superior switching performance with best in class soft body diode.

Applications

- Synchronous Rectification for ATX / Server / Telecom PSU
- Motor Drives and Uninterruptible Power Supplies
- Micro Solar Inverter

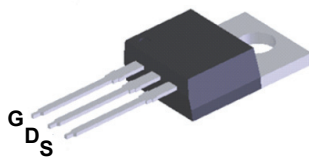

TO-220

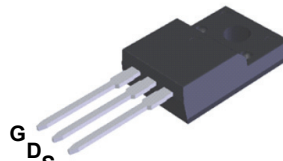

TO-220F

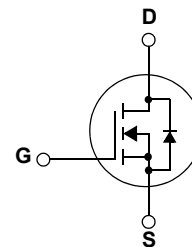

MOSFET Maximum Ratings $T_C = 25^\circ\text{C}$ unless otherwise noted.

Symbol	Parameter	Ratings		Units
		FDP4D5N10C	FDPF4D5N10C	
V_{DS}	Drain to Source Voltage	100	100	V
V_{GS}	Gate to Source Voltage	±20	±20	V
I_D	Drain Current -Continuous $T_C = 25^\circ\text{C}$ (Note 3)	128*	128*	A
	-Continuous $T_C = 100^\circ\text{C}$ (Note 3)	91	91	
	-Pulsed (Note 1)	512	512	
E_{AS}	Single Pulse Avalanche Energy (Note 2)	486		mJ
P_D	Power Dissipation $T_C = 25^\circ\text{C}$	150	37.5	W
	Power Dissipation $T_A = 25^\circ\text{C}$	2.4	2.4	
T_J, T_{STG}	Operating and Storage Junction Temperature Range	-55 to +175	-55 to +175	$^\circ\text{C}$

* Drain current limited by maximum junction temperature. Package limitation current is 120A.

Thermal Characteristics

Symbol	Parameter	FDP4D5N10C	FDPF4D5N10C	Units
$R_{\theta JC}$	Thermal Resistance, Junction to Case	1.0	4.0	$^\circ\text{C}/\text{W}$
$R_{\theta JA}$	Thermal Resistance, Junction to Ambient	62.5	62.5	

Package Marking and Ordering Information

Device Marking	Device	Package	Packing Mode	Quantity
FDP4D5N10C	FDP4D5N10C	TO-220	Tube	50 units
FDPF4D5N10C	FDPF4D5N10C	TO-220F	Tube	50 units

Electrical Characteristics $T_J = 25\text{ }^\circ\text{C}$ unless otherwise noted.

Symbol	Parameter	Test Conditions	Min.	Typ.	Max.	Units
--------	-----------	-----------------	------	------	------	-------

Off Characteristics

BV_{DSS}	Drain to Source Breakdown Voltage	$I_D = 250\ \mu\text{A}, V_{GS} = 0\ \text{V}$	100			V
$\frac{\Delta BV_{DSS}}{\Delta T_J}$	Breakdown Voltage Temperature Coefficient	$I_D = 250\ \mu\text{A}$, referenced to $25\text{ }^\circ\text{C}$		53		mV/°C
I_{DSS}	Zero Gate Voltage Drain Current	$V_{DS} = 80\ \text{V}, V_{GS} = 0\ \text{V}$			1	μA
		$V_{DS} = 80\ \text{V}, T_J = 150\text{ }^\circ\text{C}$			500	μA
I_{GSS}	Gate to Source Leakage Current	$V_{GS} = \pm 20\ \text{V}, V_{DS} = 0\ \text{V}$			± 100	nA

On Characteristics

$V_{GS(th)}$	Gate to Source Threshold Voltage	$V_{GS} = V_{DS}, I_D = 310\ \mu\text{A}$	2.0	3.2	4.0	V
$r_{DS(on)}$	Static Drain to Source On Resistance	$V_{GS} = 10\ \text{V}, I_D = 100\ \text{A}$		4.0	4.5	m Ω
g_{FS}	Forward Transconductance	$V_{DS} = 5\ \text{V}, I_D = 100\ \text{A}$		134		S

Dynamic Characteristics

C_{iss}	Input Capacitance	$V_{DS} = 50\ \text{V}, V_{GS} = 0\ \text{V},$ $f = 1\ \text{MHz}$		3615	5065	pF
C_{oss}	Output Capacitance			2330	3265	pF
C_{rss}	Reverse Transfer Capacitance			18	35	pF
R_g	Gate Resistance		0.1	1.1	2.2	Ω

Switching Characteristics

$t_{d(on)}$	Turn-On Delay Time	$V_{DD} = 50\ \text{V}, I_D = 100\ \text{A},$ $V_{GS} = 10\ \text{V}, R_{GEN} = 6\ \Omega$		29	47	ns
t_r	Rise Time			49	79	ns
$t_{d(off)}$	Turn-Off Delay Time			41	66	ns
t_f	Fall Time			13	24	ns
Q_g	Total Gate Charge	$V_{GS} = 0\ \text{V to } 10\ \text{V}$	$V_{DD} = 50\ \text{V},$ $I_D = 100\ \text{A}$	48	68	nC
Q_{gs}	Gate to Source Gate Charge			19		nC
Q_{gd}	Gate to Drain "Miller" Charge			9		nC
Q_{oss}	Output Charge	$V_{DD} = 50\ \text{V}, V_{GS} = 0\ \text{V}$		150		nC

Drain-Source Diode Characteristic

I_S	Maximum Continuous Drain to Source Diode Forward Current		-	-	128	A
I_{SM}	Maximum Pulsed Drain to Source Diode Forward Current		-	-	512	A
V_{SD}	Source to Drain Diode Forward Voltage	$V_{GS} = 0\ \text{V}, I_S = 100\ \text{A}$		1.0	1.3	V
t_{rr}	Reverse Recovery Time	$V_{GS} = 0\ \text{V}, V_{DD} = 50\ \text{V},$		82	132	ns
Q_{rr}	Reverse Recovery Charge	$I_F = 100\ \text{A}, dl_F/dt = 100\ \text{A}/\mu\text{s}$		106	170	nC
t_{rr}	Reverse Recovery Time	$V_{GS} = 0\ \text{V}, V_{DD} = 50\ \text{V},$		71	114	ns
Q_{rr}	Reverse Recovery Charge	$I_F = 100\ \text{A}, dl_F/dt = 300\ \text{A}/\mu\text{s}$		258	413	nC

Notes:

1. Pulsed I_D please refer to Figure "Forward Bias Safe Operating Area" for more details.
2. E_{AS} of 486 mJ is based on starting $T_J = 25\text{ }^\circ\text{C}$, $L = 3\ \text{mH}$, $I_{AS} = 18\ \text{A}$, $V_{DD} = 100\ \text{V}$, $V_{GS} = 10\ \text{V}$. 100% test at $L = 0.1\ \text{mH}$, $I_{AS} = 58\ \text{A}$.
3. Computed continuous current limited to Max Junction Temperature only, actual continuous current will be limited by thermal & electro-mechanical application board design.

Typical Characteristics $T_J = 25\text{ }^\circ\text{C}$ unless otherwise noted.

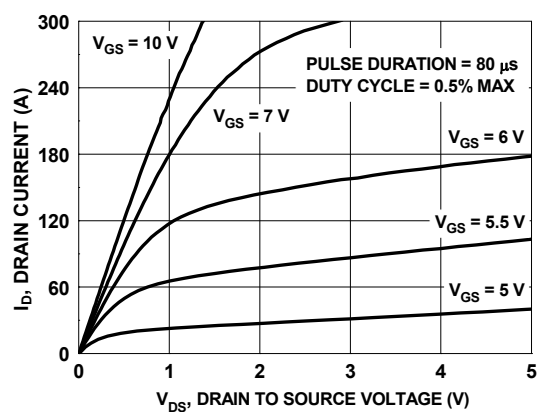

Figure 1. On Region Characteristics

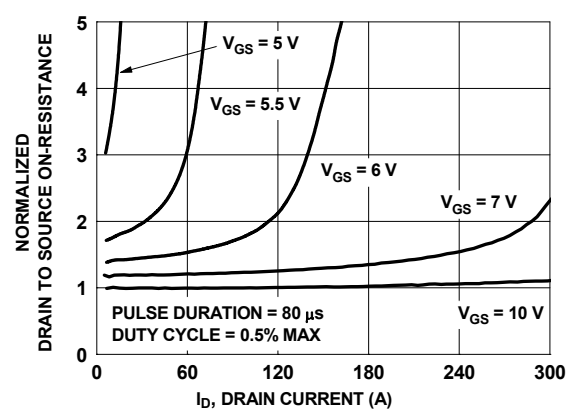

Figure 2. Normalized On-Resistance vs. Drain Current and Gate Voltage

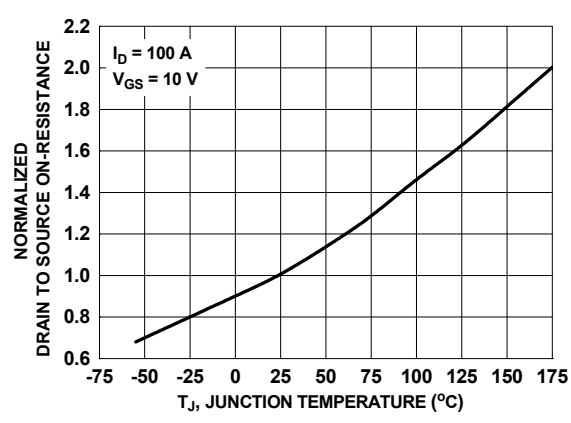

Figure 3. Normalized On Resistance vs. Junction Temperature

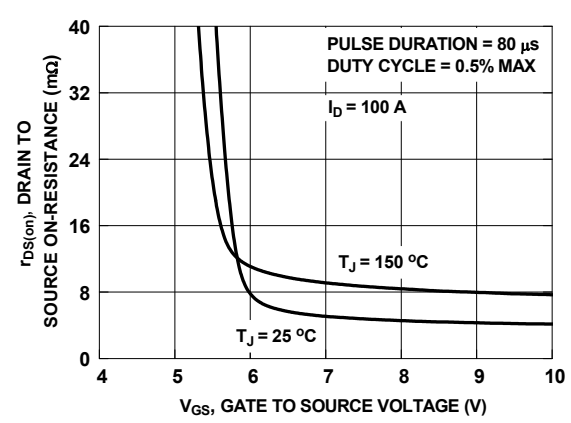

Figure 4. On-Resistance vs. Gate to Source Voltage

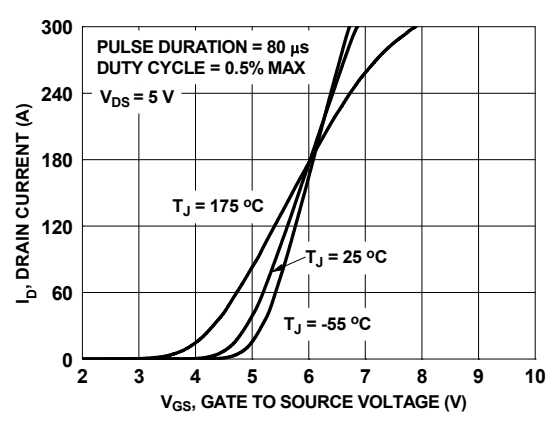

Figure 5. Transfer Characteristics

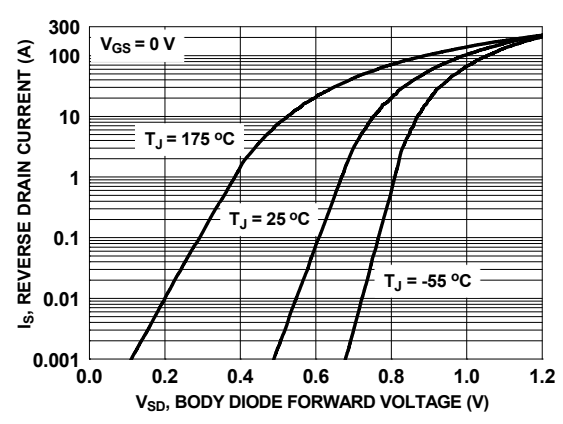

Figure 6. Source to Drain Diode Forward Voltage vs. Source Current

Typical Characteristics $T_J = 25\text{ }^\circ\text{C}$ unless otherwise noted.

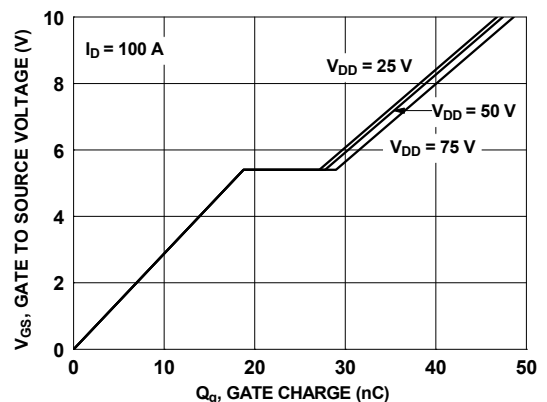

Figure 7. Gate Charge Characteristics

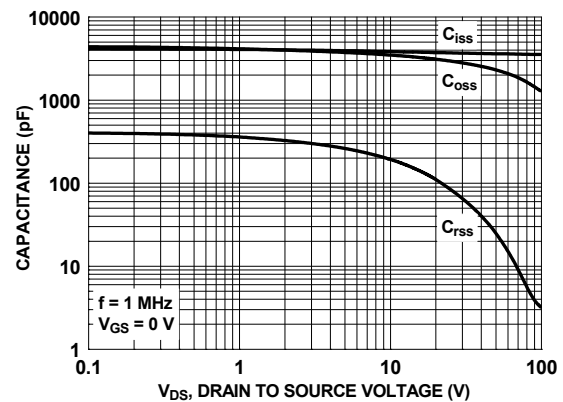

Figure 8. Capacitance vs. Drain to Source Voltage

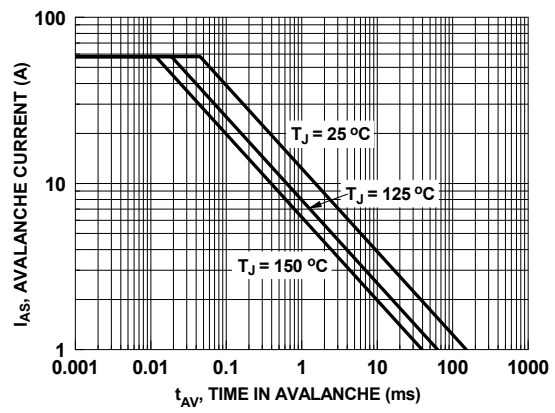

Figure 9. Unclamped Inductive Switching Capability

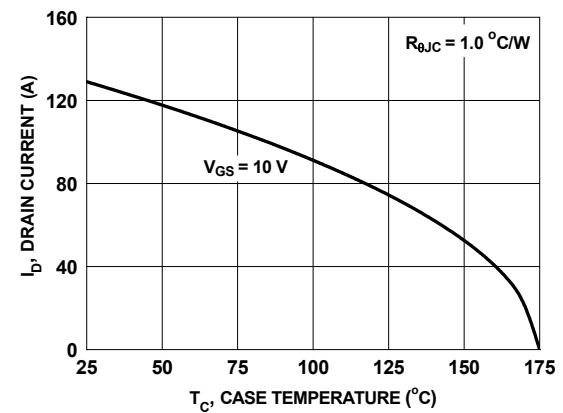

Figure 10. Maximum Continuous Drain Current vs. Case Temperature

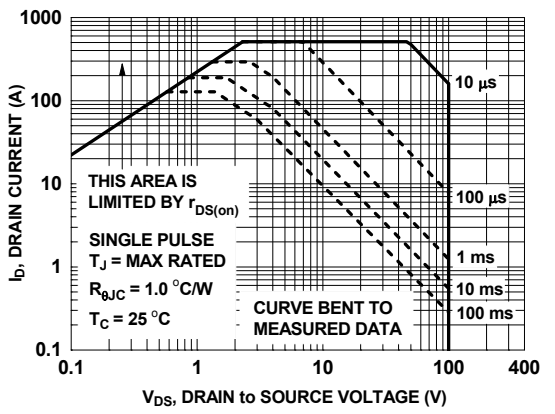

Figure 11. Forward Bias Safe Operating Area for FDP4D5N10C

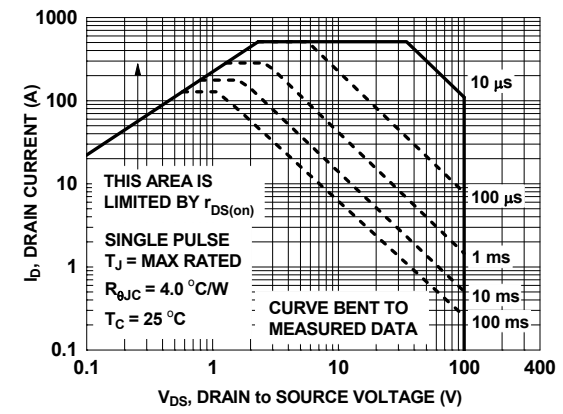

Figure 12. Forward Bias Safe Operating Area for FDPF4D5N10C

Typical Characteristics $T_J = 25\text{ }^\circ\text{C}$ unless otherwise noted.

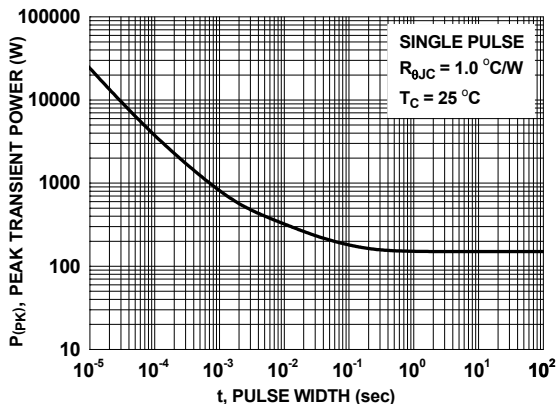

Figure 13. Single Pulse Maximum Power Dissipation for FDP4D5N10C

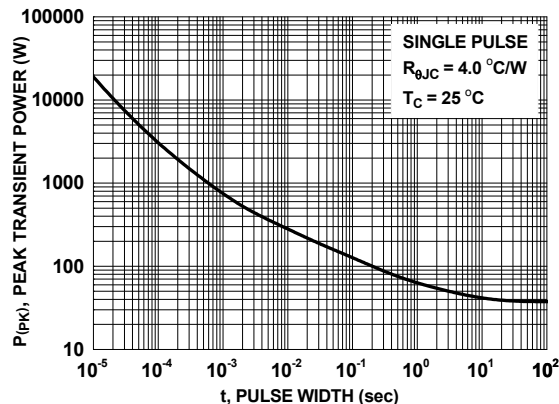

Figure 14. Single Pulse Maximum Power Dissipation for FDPF4D5N10C

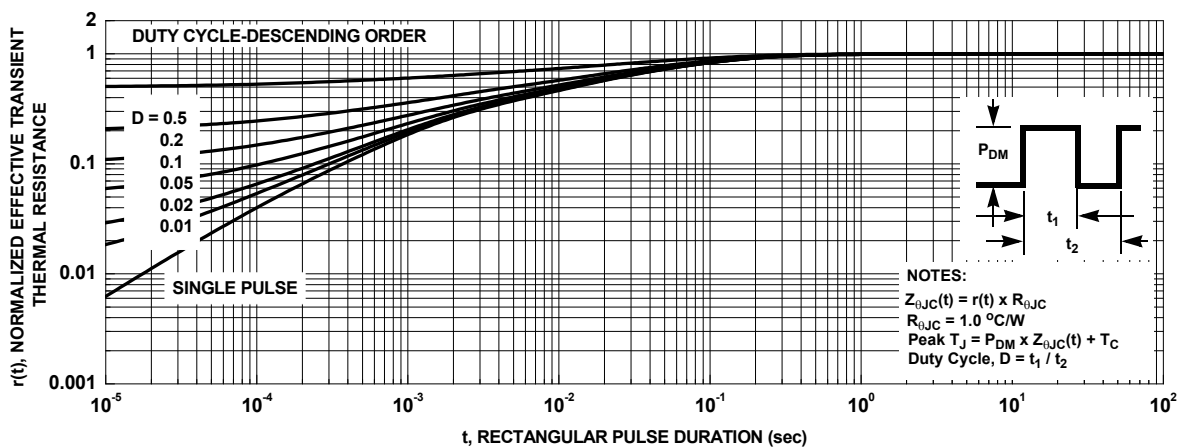

Figure 15. Junction-to-Case Transient Thermal Response Curve for FDP4D5N10C

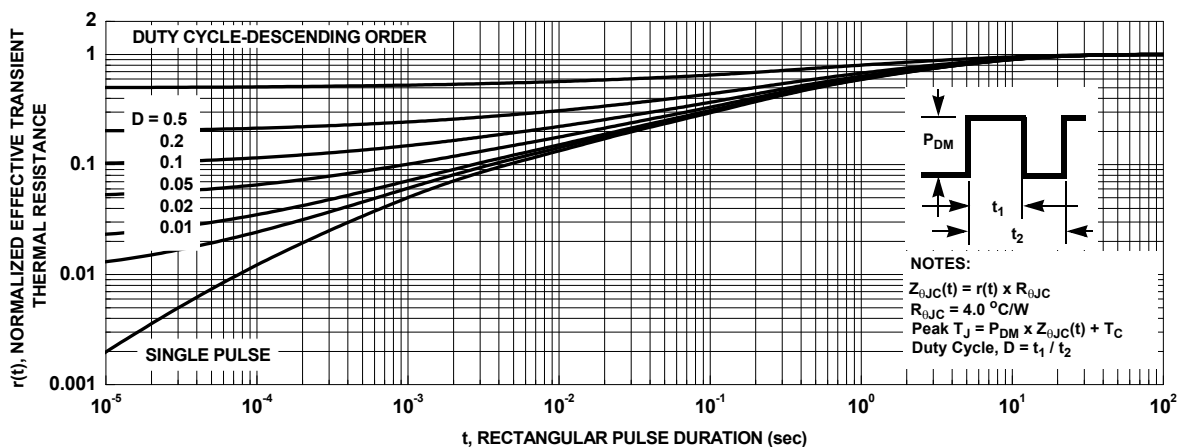
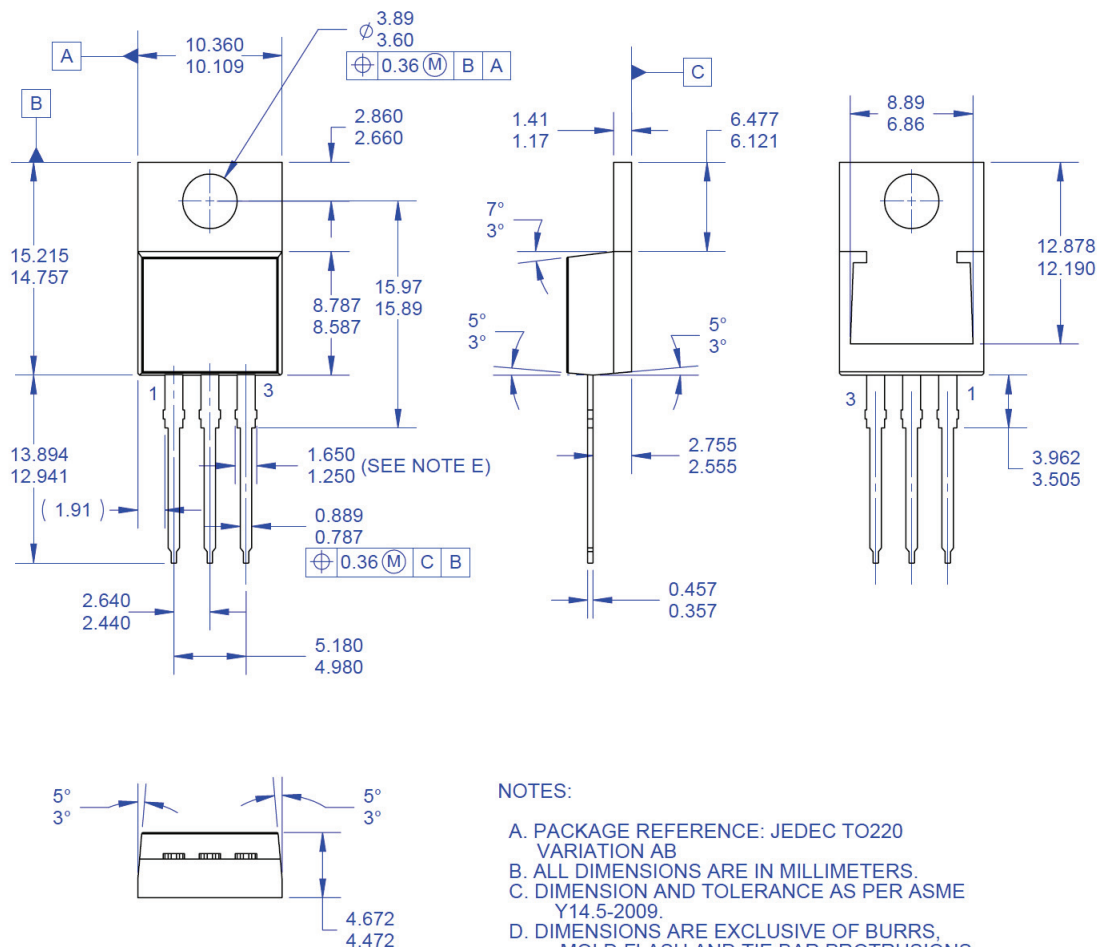

Figure 16. Junction-to-Case Transient Thermal Response Curve for FDPF4D5N10C

Dimensional Outline and Pad Layout



TO-220, Molded, 3-Lead, Jedec Variation AB (Delta)

ON Semiconductor and the ON Logo are trademarks of Semiconductor Components Industries, LLC dba ON Semiconductor or its subsidiaries in the United States and/or other countries.

ON Semiconductor owns the rights to a number of patents, trademarks, copyrights, trade secrets, and other intellectual property. A listing of ON Semiconductor's product/patent coverage may be accessed at www.onsemi.com/site/pdf/Patent-Marking.pdf. ON Semiconductor reserves the right to make changes without further notice to any products herein. ON Semiconductor makes no warranty, representation or guarantee regarding the suitability of its products for any particular purpose, nor does ON Semiconductor assume any liability arising out of the application or use of any product or circuit, and specifically disclaims any and all liability, including without limitation special, consequential or incidental damages. Buyer is responsible for its products and applications using ON Semiconductor products, including compliance with all laws, regulations and safety requirements or standards, regardless of any support or applications information provided by

ON Semiconductor. "Typical" parameters which may be provided in ON Semiconductor data sheets and/or specifications can and do vary in different applications and actual performance may vary over time. All operating parameters, including "Typicals" must be validated for each customer application by customer's technical experts. ON Semiconductor products are not designed, intended, or authorized for use as a critical component in life support systems or any FDA Class 3 medical devices or medical devices with a same or similar classification in a foreign jurisdiction or any devices intended for implantation in the human body. Should Buyer purchase or use ON Semiconductor products for any such unintended or unauthorized application, Buyer shall indemnify and hold ON Semiconductor and its officers, employees, subsidiaries, affiliates, and distributors harmless against all claims, costs, damages, and expenses, and reasonable attorney fees arising out of, directly or indirectly, any claim of personal injury or death associated with such unintended or unauthorized use, even if such claim alleges that ON Semiconductor was negligent regarding the design or manufacture of the part. ON Semiconductor is an Equal Opportunity/Affirmative Action Employer. This literature is subject to all applicable copyright laws and is not for resale in any manner.

Dimensional Outline and Pad Layout

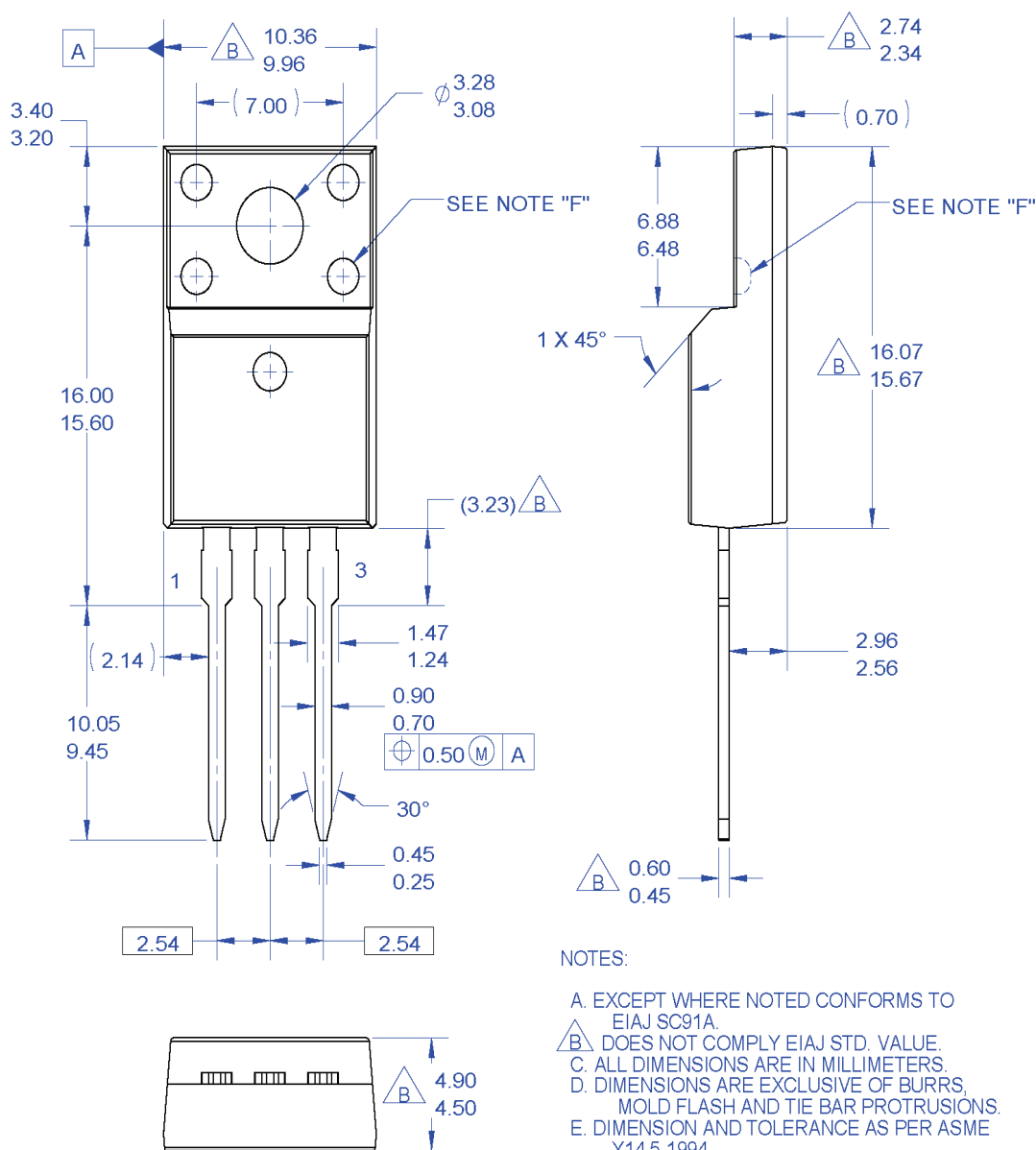

NOTES:

- A. EXCEPT WHERE NOTED CONFORMS TO EIAJ SC91A.
- B. DOES NOT COMPLY EIAJ STD. VALUE.
- C. ALL DIMENSIONS ARE IN MILLIMETERS.
- D. DIMENSIONS ARE EXCLUSIVE OF BURRS, MOLD FLASH AND TIE BAR PROTRUSIONS.
- E. DIMENSION AND TOLERANCE AS PER ASME Y14.5-1994.
- F. OPTION 1 - WITH SUPPORT PIN HOLE.
OPTION 2 - NO SUPPORT PIN HOLE.
- G. DRAWING FILE NAME: TO220M03REV3

TO220, Molded, 3-Lead, Full Pack, EIAJ SC91, Straight Lead

ON Semiconductor and the ON Logo are trademarks of Semiconductor Components Industries, LLC dba ON Semiconductor or its subsidiaries in the United States and/or other countries.

ON Semiconductor owns the rights to a number of patents, trademarks, copyrights, trade secrets, and other intellectual property. A listing of ON Semiconductor's product/patent coverage may be accessed at www.onsemi.com/site/pdf/Patent-Marking.pdf. ON Semiconductor reserves the right to make changes without further notice to any products herein. ON Semiconductor makes no warranty, representation or guarantee regarding the suitability of its products for any particular purpose, nor does ON Semiconductor assume any liability arising out of the application or use of any product or circuit, and specifically disclaims any and all liability, including without limitation special, consequential or incidental damages. Buyer is responsible for its products and applications using ON Semiconductor products, including compliance with all laws, regulations and safety requirements or standards, regardless of any support or applications information provided by ON Semiconductor. "Typical" parameters which may be provided in ON Semiconductor data sheets and/or specifications can and do vary in different applications and actual performance may vary over time. All operating parameters, including "Typicals" must be validated for each customer application by customer's technical experts. ON Semiconductor does not convey any license under its patent rights nor the rights of others. ON Semiconductor products are not designed, intended, or authorized for use as a critical component in life support systems or any FDA Class 3 medical devices or medical devices with a same or similar classification in a foreign jurisdiction or any devices intended for implantation in the human body. Should Buyer purchase or use ON Semiconductor products for any such unintended or unauthorized application, Buyer shall indemnify and hold ON Semiconductor and its officers, employees, subsidiaries, affiliates, and distributors harmless against all claims, costs, damages, and expenses, and reasonable attorney fees arising out of, directly or indirectly, any claim of personal injury or death associated with such unintended or unauthorized use, even if such claim alleges that ON Semiconductor was negligent regarding the design or manufacture of the part. ON Semiconductor is an Equal Opportunity/Affirmative Action Employer. This literature is subject to all applicable copyright laws and is not for resale in any manner.