

TPS22950x 5.5-V, 2.7-A, 34-mΩ Adjustable Current Limited Load Switch

1 Features

- Input operating voltage range (V_{IN}): 1.8 V–5.5 V
- Output current limit (I_{LIMIT}): 0.05 A–3.5 A (typ.)
- TPS22950: Auto-retry current limit response
- TPS22950L: Latch off current limit response
- Thermal Shutdown (TSD)
- ON-Resistance (R_{ON}):
 - R_{ON} at $V_{IN} = 5$ V: 34 mΩ (typ.)
 - R_{ON} at $V_{IN} = 3.3$ V: 41 mΩ (typ.)
- Slow turn-ON timing limits inrush current (typ.):
 - t_{ON} at $V_{IN} = 5$ V: 800 μ s
 - t_{ON} at $V_{IN} = 3.3$ V: 550 μ s
- Always-ON reverse current blocking (TPS22950)
- Fault indication (FLT)
- Quick Output Discharge (QOD): 150 Ω
- Smart ON pin pulldown ($R_{PD,ON}$):
 - $ON \geq V_{IH}$ (I_{ON}): 50 nA (max.)
 - $ON \leq V_{IL}$ ($R_{PD,ON}$): 500 kΩ (typ.)
- Low power consumption:
 - ON state (I_Q): 40 μ A (typ.)
 - OFF state (I_{SD}): 0.2 μ A (typ.)
- UL 2367 Recognition – File No. E169910
 - Certified from $I_{LIM} = 66$ mA to 2.46 A

2 Application

- Personal electronics
- Tablets
- Notebooks
- Game consoles
- Accessories

3 Description

The TPS22950x is a small, single channel load switch with robust protection against fault cases with adjustable output current limiting, reverse current blocking, and thermal shutdown.

The switch ON state is controlled by a digital input that is capable of interfacing directly with low-voltage control signals. When power is first applied, a Smart Pulldown is used to keep the ON pin from floating until system sequencing is complete. After the pin is deliberately driven high ($>V_{IH}$), the Smart Pulldown is disconnected to prevent unnecessary power loss.

The TPS22950 responds to overcurrent events with auto-retry behavior, while the TPS22950L uses a debounce time and latch off behavior.

TPS22950x is available in a standard WCSP package characterized for operation over an ambient temperature range of -40°C to 125°C .

Device Information

PART NUMBER	PACKAGE	BODY SIZE (NOM)
TPS22950, TPS22950L	WCSP (6)	1.106 mm \times 0.706 mm

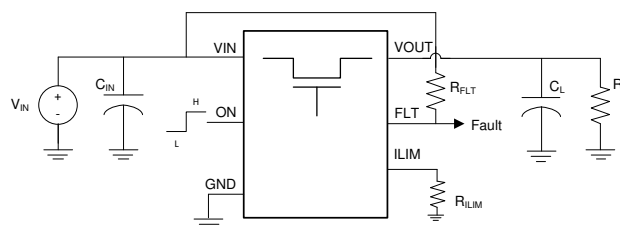

Typical Application



Table of Contents

1 Features	1	9.3 Feature Description.....	11
2 Application	1	9.4 Device Functional Modes.....	14
3 Description	1	10 Application and Implementation	16
4 Revision History	2	10.1 Application Information.....	16
5 Device Comparison Table	3	10.2 Typical Application.....	16
6 Pin Configuration and Functions	4	11 Power Supply Recommendations	18
7 Specifications	5	12 Layout	19
7.1 Absolute Maximum Ratings.....	5	12.1 Layout Guidelines.....	19
7.2 ESD Ratings.....	5	12.2 Layout Example.....	19
7.3 Recommended Operating Conditions.....	5	13 Device and Documentation Support	20
7.4 Thermal Information.....	5	13.1 Receiving Notification of Documentation Updates.....	20
7.5 Electrical Characteristics.....	6	13.2 Support Resources.....	20
7.6 Switching Characteristics.....	7	13.3 Trademarks.....	20
7.7 Typical Characteristics.....	8	13.4 Electrostatic Discharge Caution.....	20
8 Parameter Measurement Information	10	13.5 Glossary.....	20
9 Detailed Description	11	14 Mechanical, Packaging, and Orderable Information	21
9.1 Overview.....	11		
9.2 Functional Block Diagram.....	11		

4 Revision History

NOTE: Page numbers for previous revisions may differ from page numbers in the current version.

Changes from Revision * (December 2020) to Revision A (June 2022)	Page
• Added the TPS22950L orderable to the data sheet	1
• Updated ESD ratings table to the latest standard.....	5
• Added line items in Electrical Characteristics to reflect TPS22950L parameters.....	5
• Updated the Overview section in Detailed Description to include device functionality	11
• Added a Current Limiting section to describe the latch off functionality of TPS22950L	13

5 Device Comparison Table

DEVICE NAME	ILIM Range	ILIM Response	Debounce Time	RCB
TPS22950	0.05 A to 3.5 A	Auto-Retry	No	Yes
TPS22950L	0.5 A to 3.5 A	Latch Off	Yes	No

6 Pin Configuration and Functions

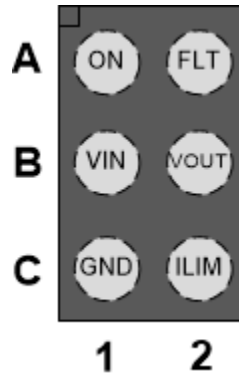

Figure 6-1. TPS22950x WCSP - 6 Top View

Table 6-1. Pin Functions

PIN		I/O	DESCRIPTION
NAME	NO.		
ON	A1	I	Active high switch control input. Do not leave floating.
FLT	A2	O	Open-drain output, pulled low during thermal shutdown or reverse current-conditions.
VIN	B1	I	Switch input
VOUT	B2	O	Switch output
GND	C1	—	Device ground
ILIM	C2	O	Adjusts device current limit through a resistor to ground.

7 Specifications

7.1 Absolute Maximum Ratings

over operating free-air temperature range (unless otherwise noted)⁽¹⁾

		MIN	MAX	UNIT
V _{IN}	Maximum Input Voltage Range	-0.3	6	V
V _{OUT}	Maximum Output Voltage Range	-0.3	6	V
V _{ON}	Maximum ON Pin Voltage Range	-0.3	6	V
V _{FLT}	Maximum FLT Pin Voltage	-0.3	6	V
I _{MAX}	Maximum Continuous Output Current		2.7	A
I _{MAX,PLS}	Maximum Pulsed Output Current (T _J = 85°C, duty cycle = 2%)		4.1	A
T _{STG}	Storage temperature	-65	150	°C
T _{LEAD}	Maximum Lead Temperature (10 s soldering time)		300	°C

- (1) Stresses beyond those listed under *Absolute Maximum Rating* may cause permanent damage to the device. These are stress ratings only, which do not imply functional operation of the device at these or any other conditions beyond those indicated under *Recommended Operating Condition*. Exposure to absolute-maximum-rated conditions for extended periods may affect device reliability.

7.2 ESD Ratings

			VALUE	UNIT
V _(ESD)	Electrostatic discharge	Human body model (HBM), per ANSI/ESDA/ JEDEC JS-001 ⁽¹⁾	±2000	V
		Charged device model (CDM), per ANSI/ESDA/ JEDEC JS-002 ⁽²⁾	±500	

- (1) JEDEC document JEP155 states that 500-V HBM allows safe manufacturing with a standard ESD control process.
(2) JEDEC document JEP157 states that 250-V CDM allows safe manufacturing with a standard ESD control process.

7.3 Recommended Operating Conditions

over operating free-air temperature range (unless otherwise noted)

		MIN	TYP	MAX	UNIT
V _{IN}	Input Voltage Range	1.8		5.5	V
V _{OUT}	Output Voltage Range	0		5.5	V
V _{IH}	ON Pin High Voltage Range	1		5.5	V
V _{IL}	ON Pin Low Voltage Range	0		0.35	V
I _{LIM}	Output Current Limit (TPS22950)	0.05		3.5	A
I _{LIM}	Output Current Limit (TPS22950L)	0.5		3.5	A
T _A	Ambient temperature	-40		125	°C
T _J	Junction temperature	-40		150	°C

7.4 Thermal Information

THERMAL METRIC ⁽¹⁾		TPS22950	UNIT
		YBH (WCSP)	
		6 PINS	
R _{θJA}	Junction-to-ambient thermal resistance	135.8	°C/W
R _{θJC(top)}	Junction-to-case (top) thermal resistance	1.4	°C/W
R _{θJB}	Junction-to-board thermal resistance	39.5	°C/W
Ψ _{JT}	Junction-to-top characterization parameter	0.9	°C/W

7.4 Thermal Information (continued)

THERMAL METRIC ⁽¹⁾		TPS22950	UNIT
		YBH (WCSP)	
		6 PINS	
Ψ_{JB}	Junction-to-board characterization parameter	39.5	°C/W

(1) For more information about traditional and new thermal metrics, see the [Semiconductor and IC Package Thermal Metrics](#) application report.

7.5 Electrical Characteristics

Unless otherwise noted, the characteristics in the following table apply across the recommended operating input voltage range with a load of $C_L = 0.1 \mu\text{F}$, $R_L = 100 \Omega$. Typical Values are at 5 V and $T_A = 25^\circ\text{C}$.

PARAMETER		TEST CONDITIONS	MIN	TYP	MAX	UNIT	
Input Supply (VIN)							
$I_{Q, VIN}$	VIN Quiescent Current	$V_{ON} \geq V_{IH}$, $V_{OUT} = \text{Open}$	-40°C to 85°C	44	60	μA	
			-40°C to 125°C		60	μA	
$I_{SD, VIN}$	VIN Shutdown Current	$V_{ON} \leq V_{IL}$, $V_{OUT} = \text{GND}$	25°C	0.2	0.4	μA	
			-40°C to 85°C		9	μA	
			-40°C to 125°C		46	μA	
ON-Resistance (RON)							
R_{ON}	ON-State Resistance	$V_{IN} = 5 \text{ V}$, $I_{OUT} = -200 \text{ mA}$	25°C	34	41	m Ω	
			-40°C to 85°C		49	m Ω	
			-40°C to 125°C		54	m Ω	
		$V_{IN} = 3.3 \text{ V}$, $I_{OUT} = -200 \text{ mA}$	25°C	41	51	m Ω	
			-40°C to 85°C		62	m Ω	
			-40°C to 125°C		68	m Ω	
		$V_{IN} = 1.8 \text{ V}$, $I_{OUT} = -200 \text{ mA}$	25°C	67	90	m Ω	
			-40°C to 85°C		105	m Ω	
			-40°C to 125°C		116	m Ω	
Output Current Limit (ILIM)							
I_{LIM}	Output Current Limit	$R_{ILIM} = 610 \Omega$ $V_{IN} - V_{OUT} = 0.5 \text{ V}$	-40°C to 125°C	1.54	2	2.46	A
		$R_{ILIM} = 1.15 \text{ k}\Omega$ $V_{IN} - V_{OUT} = 0.5 \text{ V}$	-40°C to 125°C	0.75	1	1.25	A
		$R_{ILIM} = 2.21 \text{ k}\Omega$ $V_{IN} - V_{OUT} = 0.5 \text{ V}$	-40°C to 125°C	0.38	0.5	0.62	A
		$R_{ILIM} = 19.2 \text{ k}\Omega$ $V_{IN} - V_{OUT} = 0.5 \text{ V}$	-40°C to 125°C	0.034	0.05	0.066	A
$I_{LIM, PEAK}$	Output Current Limit Peak (TPS22950L)	$R_{ILIM} = 624 \Omega$ $V_{IN} - V_{OUT} = 1 \text{ V}$	-40°C to 125°C	2.1		A	
		$R_{ILIM} = 1.24 \text{ k}\Omega$ $V_{IN} - V_{OUT} = 1 \text{ V}$	-40°C to 125°C	1		A	
		$R_{ILIM} = 2.49 \text{ k}\Omega$ $V_{IN} - V_{OUT} = 1 \text{ V}$	-40°C to 125°C	0.52		A	
t_{LIM}	Current Limit Response Time	Output hard short ($I_{OUT} > I_{LIM}$)	-40°C to 125°C	5		μs	
$t_{DEBOUNCE}$	Latch Off Debounce Time (TPS22950L)	$V_{IN} - V_{OUT} = 0.5 \text{ V}$	-40°C to 125°C	120	188	μs	
I_{HCD}	High current detection threshold (TPS22950L)	$R_{ILIM} = 624 \Omega$	-40°C to 125°C	1.2	1.6	1.9	A
		$R_{ILIM} = 1.25 \text{ k}\Omega$	-40°C to 125°C	0.6	0.85	1.1	A
		$R_{ILIM} = 2.5 \text{ k}\Omega$	-40°C to 125°C	0.3	0.47	0.65	A

7.5 Electrical Characteristics (continued)

Unless otherwise noted, the characteristics in the following table apply across the recommended operating input voltage range with a load of $C_L = 0.1 \mu\text{F}$, $R_L = 100 \Omega$. Typical Values are at 5 V and $T_A = 25^\circ\text{C}$.

PARAMETER		TEST CONDITIONS		MIN	TYP	MAX	UNIT
Reverse Current Blocking (TPS22950)							
V_{RCB}	Activation Threshold	V_{OUT} Rising; $V_{OUT} > V_{IN}$	-40°C to 125°C		44		mV
	Release Threshold	V_{OUT} Falling; $V_{OUT} > V_{IN}$	-40°C to 125°C		16		mV
t_{RCB}	Response Time	$V_{OUT} = V_{IN} + 1 \text{ V}$	-40°C to 125°C		3		μs
$I_{OUT,RCB}$	Reverse Leakage Current into VOUT	$V_{ON} \leq V_{IL}$ $V_{IN} = 0 \text{ V}$, $V_{OUT} = 5 \text{ V}$	-40°C to 125°C			38	μA
Fault Indication (FLT)							
$V_{OL,FLT}$	Output Low Voltage	$I_{FLT} = 1 \text{ mA}$	-40°C to 125°C			0.1	V
$t_{D,FLT}$	Fault Delay Time	$V_{ON} \geq V_{IH}$	-40°C to 125°C		10		μs
I_{FLT}	Off State Leakage	$V_{ON} \leq V_{IL}$	-40°C to 125°C			50	nA
Enable Pin (ON)							
$R_{PD,ON}$	Smart Pull Down Resistance	$V_{ON} \leq V_{IL}$	-40°C to 125°C		500	650	k Ω
I_{ON}	ON Pin Leakage	$V_{ON} \geq V_{IH}$	-40°C to 125°C			50	nA
R_{QOD}	Quick Output Discharge Resistance	$V_{IN} = 5 \text{ V}$ $V_{ON} \leq V_{IL}$	-40°C to 125°C		100	160	Ω
		$V_{IN} = 3.3 \text{ V}$ $V_{ON} \leq V_{IL}$	-40°C to 125°C		150	185	Ω
		$V_{IN} = 1.8 \text{ V}$ $V_{ON} \leq V_{IL}$	-40°C to 125°C		200	355	Ω
Thermal Shutdown (TSD)							
TSD	Thermal Shutdown	Rising	N/A		170		$^\circ\text{C}$
		Falling (Hysteresis)	N/A		150		$^\circ\text{C}$

7.6 Switching Characteristics

Unless otherwise noted, the typical characteristics in the following table applies at 25°C with a load of $C_L = 1 \mu\text{F}$, $R_L = 100 \Omega$

PARAMETER		TEST CONDITIONS		MIN	TYP	MAX	UNIT
t_{ON}	Turn ON Time	$V_{IN} = 5 \text{ V}$			800		μs
		$V_{IN} = 3.3 \text{ V}$			550		μs
		$V_{IN} = 1.8 \text{ V}$			400		μs
t_R	Output Rise Time	$V_{IN} = 5 \text{ V}$			600		μs
		$V_{IN} = 3.3 \text{ V}$			320		μs
		$V_{IN} = 1.8 \text{ V}$			200		μs
t_D	Output Delay Time	$V_{IN} = 5 \text{ V}$			260		μs
		$V_{IN} = 3.3 \text{ V}$			250		μs
		$V_{IN} = 1.8 \text{ V}$			260		μs
t_{OFF}	Turn OFF Time	$V_{IN} = 5 \text{ V}$			20		μs
		$V_{IN} = 3.3 \text{ V}$			15		μs
		$V_{IN} = 1.8 \text{ V}$			17		μs
t_{FALL}	Output Fall Time	$V_{IN} = 5 \text{ V}$			118		μs
		$V_{IN} = 3.3 \text{ V}$			120		μs
		$V_{IN} = 1.8 \text{ V}$			130		μs

7.7 Typical Characteristics

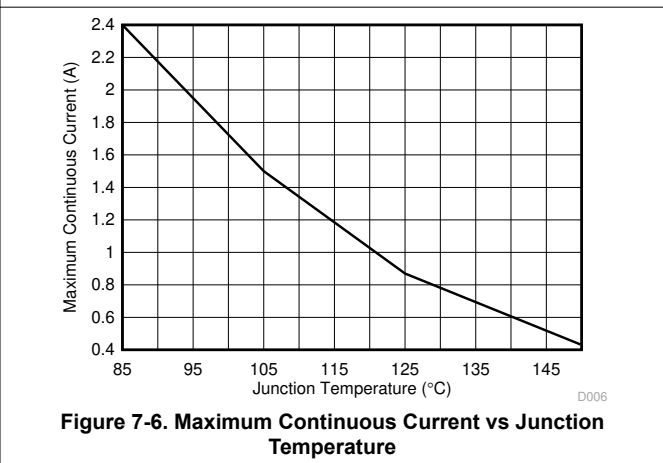
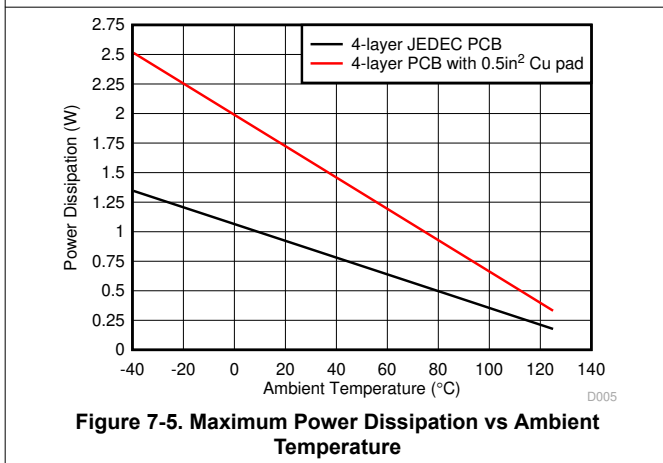
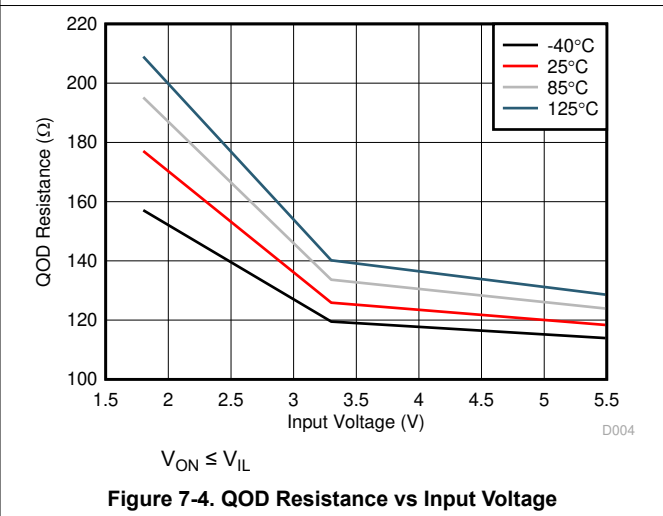
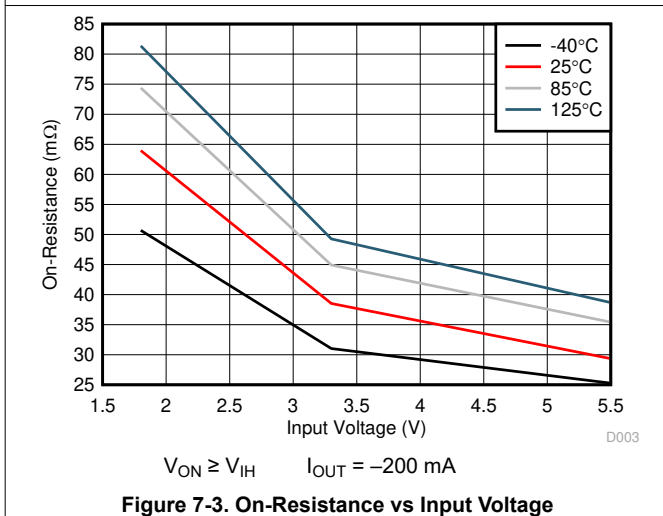
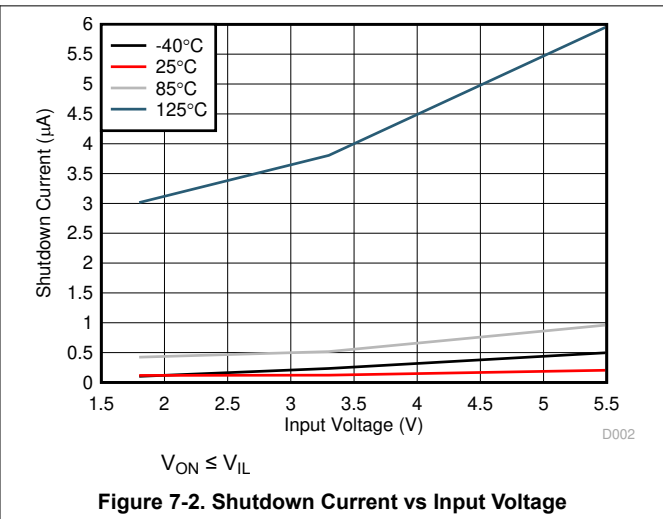
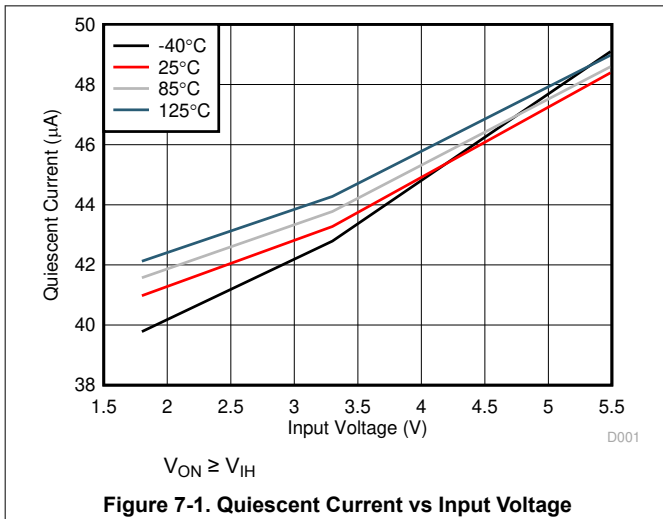

7.7 Typical Characteristics (continued)

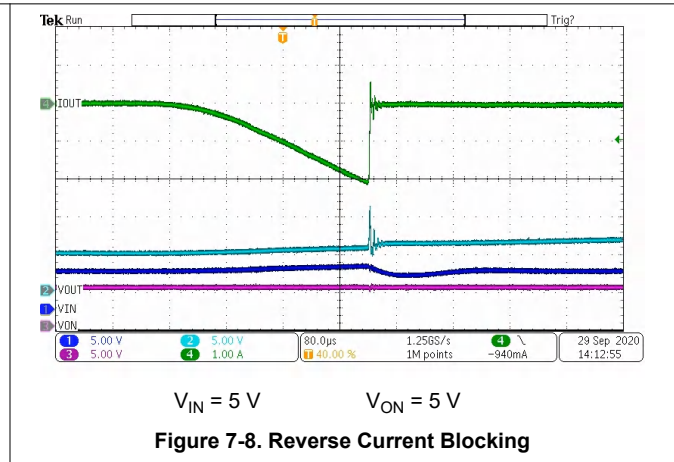
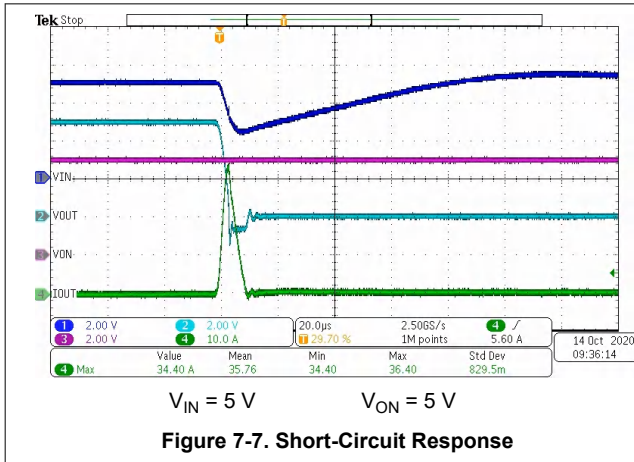

8 Parameter Measurement Information

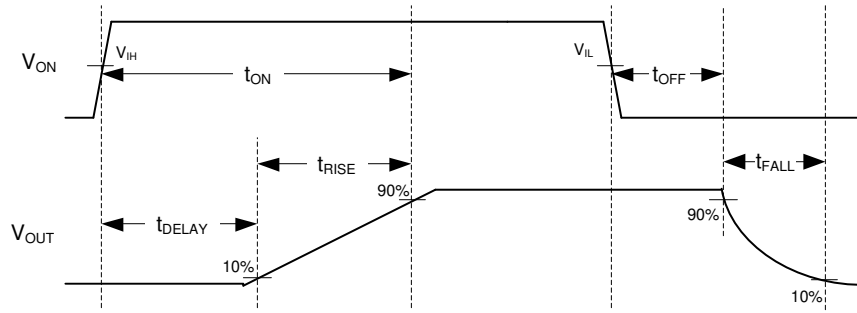

Figure 8-1. Timing Waveform

9 Detailed Description

9.1 Overview

The TPS22950x is a single channel load switch with a 34-mΩ power MOSFET capable of driving loads up to 2.7 A. While on, the device provides protection against fault cases through its adjustable output current limiting and thermal shutdown. The TPS22950 responds to overcurrent events with auto-retry behavior, while the TPS22950L uses a debounce time and latch off behavior. The TPS22950 also provides reverse current blocking for when V_{OUT} exceeds V_{IN} .

The switch ON state is controlled by a digital input that is capable of interfacing directly with low-voltage control signals, and a Smart Pulldown is used to keep the ON pin from floating until system sequencing is complete. When the device is turned off, quick output discharge is enabled, pulling the output voltage down to 0 V through a resistive path to GND.

9.2 Functional Block Diagram

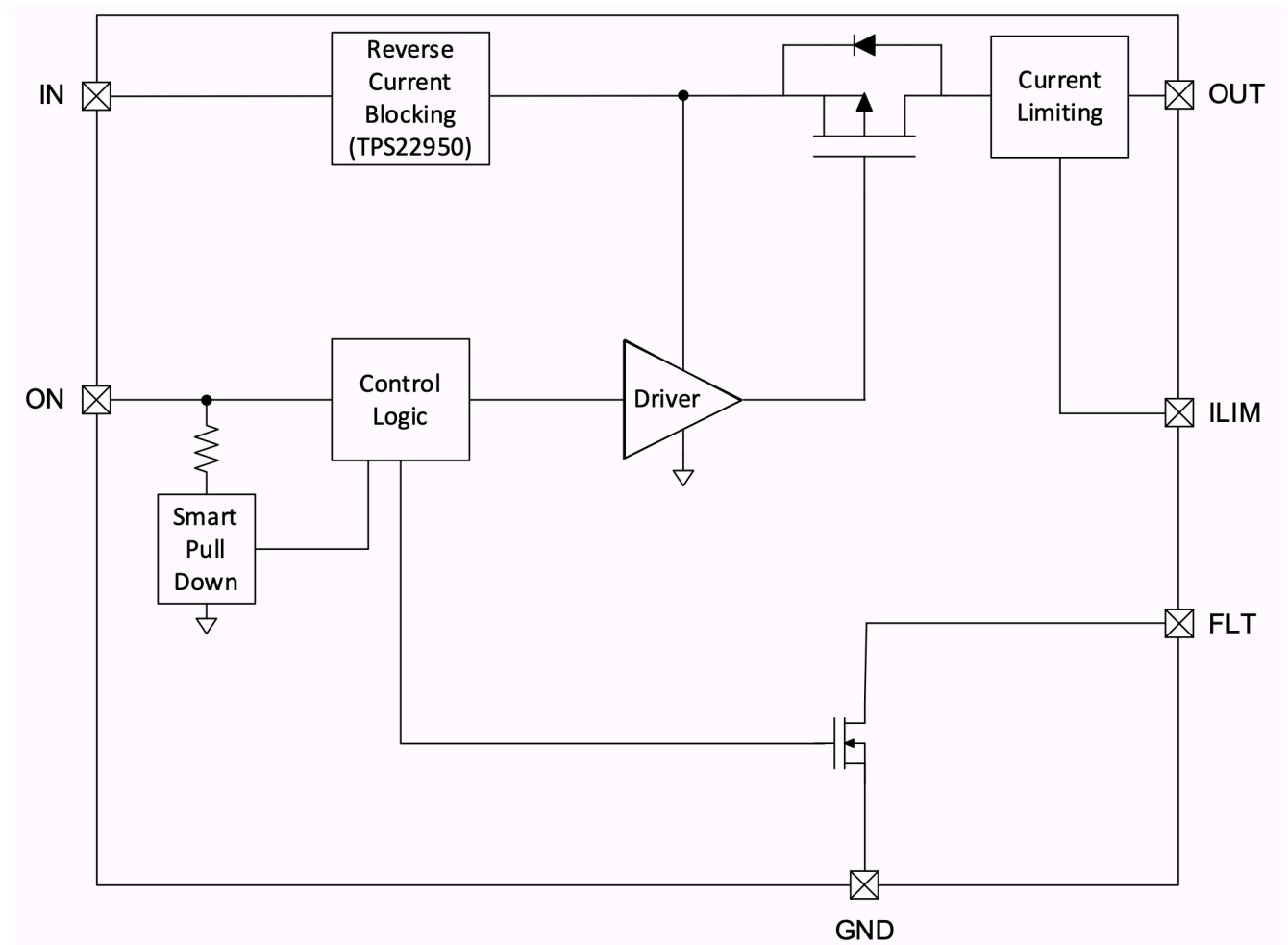

9.3 Feature Description

9.3.1 Current Limiting (TPS22950)

The TPS22950 responds to overcurrent conditions by limiting its output current to the I_{LIM} level shown in the figure below.

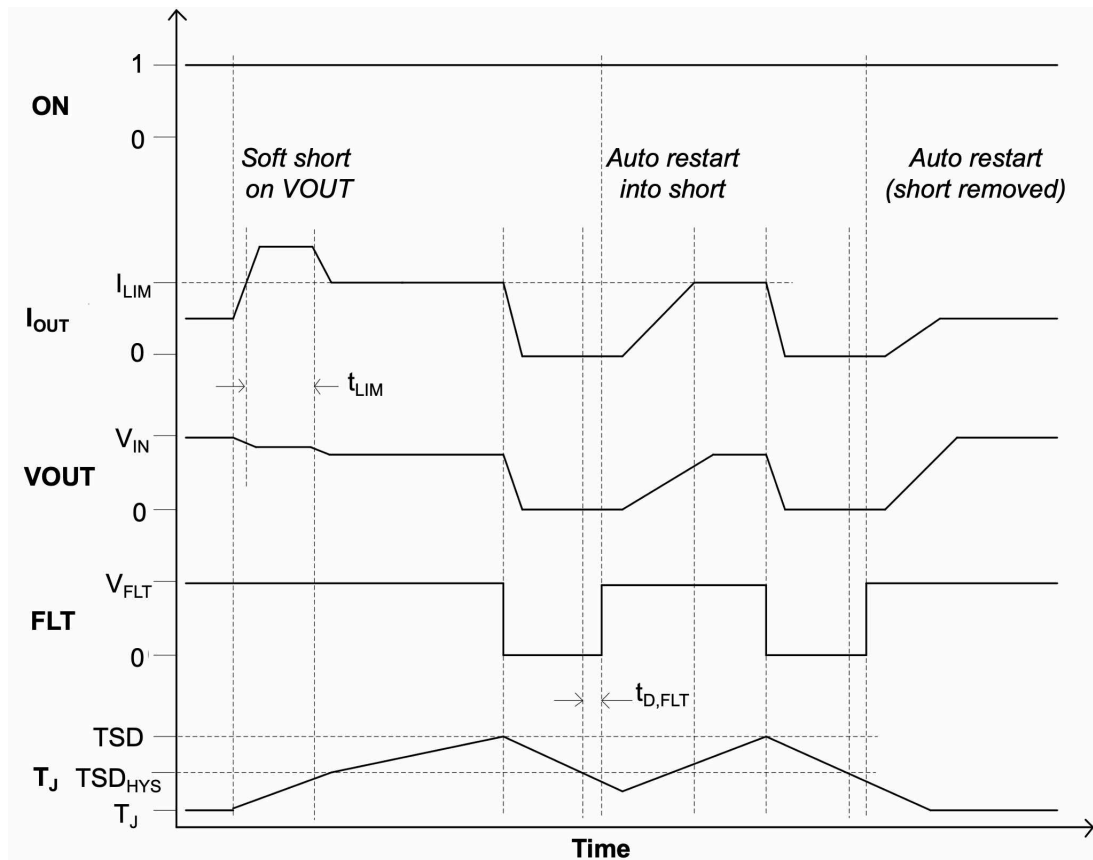

Figure 9-1. Output Current Limit for Short-Circuit Protection (t_{LIM})

When an overcurrent condition is detected, the device maintains a constant output current and reduces the output voltage accordingly. Two possible overload conditions can occur.

The first condition is when a short circuit or partial short circuit is present on the output and the ON pin is toggled high, turning the device on. The output voltage is held near zero potential with respect to ground and the TPS22950 ramps the output current to I_{LIM} . The TPS22950 device limits the current to I_{LIM} until the overload condition is removed or the internal junction temperature of the device reaches thermal shutdown and the device turns itself off. The device remains off until the junction temperature has lowered to TSD_{HYS} , and the device turns itself back on. This action cycles until the overload condition is removed.

The second condition is when a short circuit, partial short circuit, or transient overload occurs after the device has been fully powered on. The device responds to the overcurrent condition within time t_{LIM} (see figure below), and before this time the current is able to exceed I_{LIM} . In the case of a fast transient, the current-sense amplifier is over-driven and momentarily disables the internal power FET. The current-sense amplifier recovers and limits the output current to I_{LIM} . Similar to the previous case, the TPS22950 limits the current to I_{LIM} until the overload condition is removed or the internal junction temperature of the device reaches thermal shutdown and begins thermally cycling on and off.

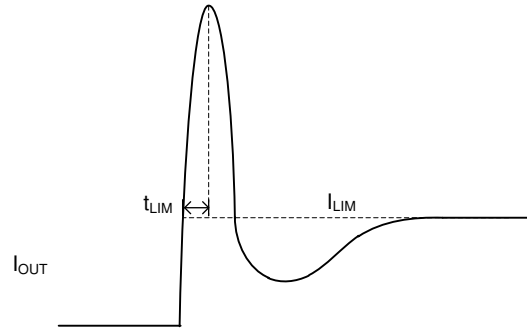

Figure 9-2. Transient Current Limit Waveform

9.3.2 Current Limiting (TPS22950L)

The TPS22950L responds to overcurrent conditions by limiting its output current to the current limit (I_{LIM}) level after initially peaking its current at $I_{LIM,PEAK}$. The behavior of the device is shown in the figure below.

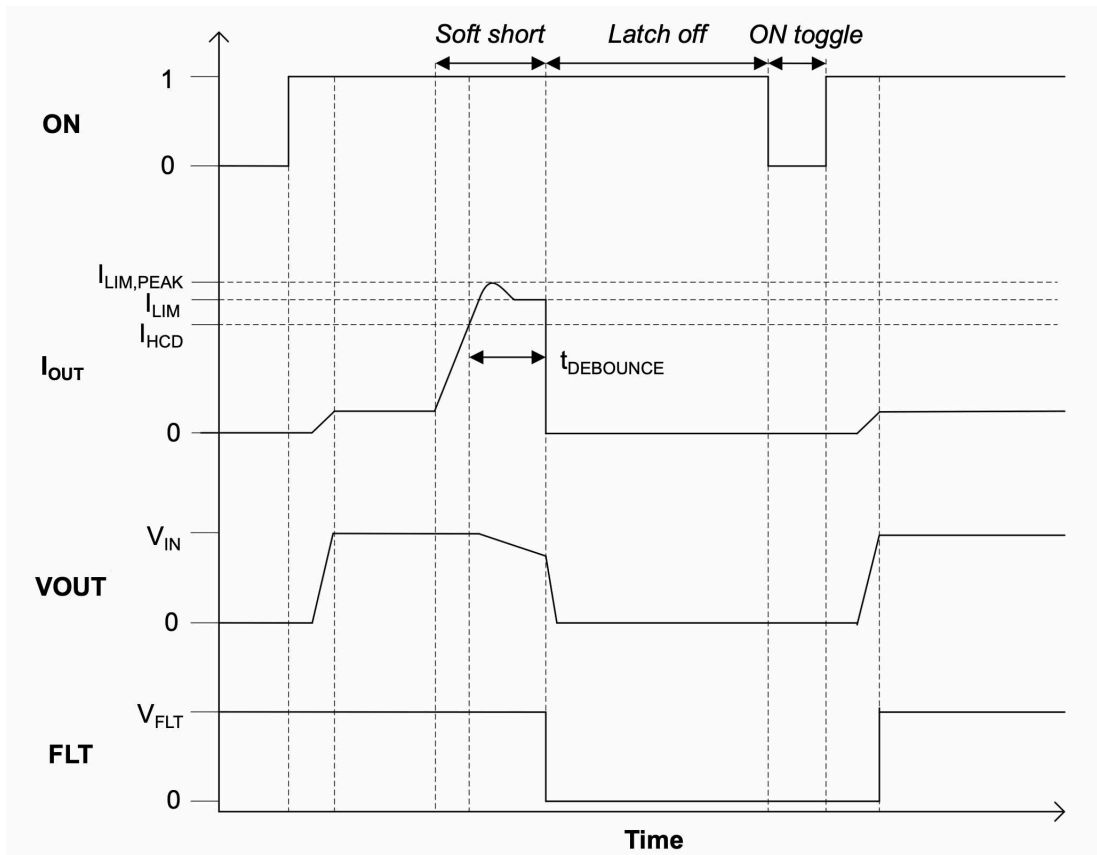

Figure 9-3. Output Current Limit Behavior

When an overcurrent condition is detected, the device maintains a constant output current and reduces the output voltage accordingly. Two possible overload conditions can occur.

The first condition is when a short circuit or partial short circuit is present on the output and the ON pin is toggled high, turning the device on. The output voltage is held near zero potential with respect to ground and the TPS22950L ramps the output current to I_{LIM} . The TPS22950L device limits the current to I_{LIM} until the overload condition is removed. If the internal junction temperature of the device reaches thermal shutdown, the device turns itself off. The device remains off until the junction temperature has lowered to TSD_{HYS} , and the device turns itself back on. If thermal shutdown is not reached, the device waits for the load current to exceed the high

current detection level (I_{HCD}) for the $t_{DEBOUNCE}$ time and latch itself off. The FLT pin is pulled low, and the device is only able to turn on again by toggling the VIN or ON pins.

The second condition is when a short circuit, partial short circuit, or transient overload occurs after the device has been fully powered on. The device responds to the overcurrent condition within time t_{LIM} (see figure below), and before this time the current is able to exceed I_{LIM} . In the case of a fast transient, the current-sense amplifier is over-driven and momentarily disables the internal power FET. The current-sense amplifier recovers and limits the output current to I_{LIM} . Similar to the previous case, the TPS22950L limits the current to I_{LIM} until the overload condition is removed, the debounce time of 120 μ s is reached, or the internal junction temperature of the device reaches thermal shutdown and begins thermally cycling on and off.

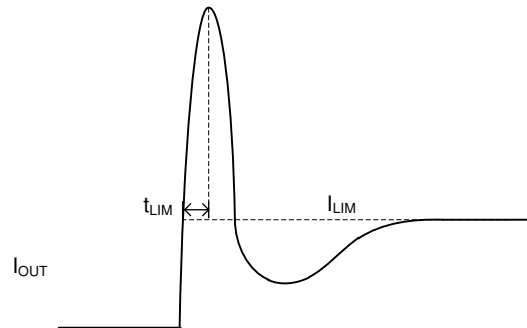

Figure 9-4. Transient Current Limit Waveform

9.3.3 Adjusting the Current Limit

The current limit is adjusted by connecting an external resistor from the ILIM pin to GND. The current limit resistor can be chosen using the equation:

$$I_{LIM} = 1.18 \times (R_{ILIM})^{-1.072} \quad (1)$$

The units for the equation are amps for I_{LIM} and kilohms for R_{ILIM} . For the TPS22950L, the device is only limiting current during a short period of time. Therefore, the peak value of the current ($I_{LIM,PEAK}$) may be more applicable for system considerations. The equation for this parameter is below:

$$I_{LIM,PEAK} = 1.31 \times (R_{ILIM})^{-1.042} \quad (2)$$

The R_{ILIM} resistor is also used to set the high current detection threshold for the TPS22950L, and that equation is shown below.

$$I_{HCD} = (0.988 / R_{ILIM}) + 0.06 \quad (3)$$

The units for the equation are amps for I_{HCD} and kilohms for R_{ILIM} .

9.3.4 Reverse Current Blocking (TPS22950)

In a scenario where the device is enabled and V_{OUT} is greater than V_{IN} , there is potential for reverse current to flow through the pass FET or the body diode. When the reverse current threshold is exceeded (about 900 mA), there is a delay time (t_{RCB}) before the switch turns off to stop the current flow. The switch remains off and block reverse current as long as the reverse voltage condition exists. After V_{OUT} has dropped below the release voltage threshold (V_{RCB}) the device turns back on. When the ON pin is pulled low, the device constantly blocks reverse current.

9.4 Device Functional Modes

The tables below summarize the Device Functional Modes.

Table 9-1. Output Connection Table

ON	Fault Condition	VOUT State	FLT State
L	N/A	Hi-Z	Hi-Z
H	None	VIN (via R_{ON})	Hi-Z

Table 9-1. Output Connection Table (continued)

ON	Fault Condition	VO _{UT} State	FLT State
H	Output short	Current Limited	Hi-Z
H	Thermal shutdown	Hi-Z	L
H	Reverse current	Hi-Z	L

Table 9-2. Smart-ON Functional Modes (R_{PD,ON})

ON	ON Pin
$\leq V_{IL}$	Pulldown active
$\geq V_{IH}$	No pulldown

10 Application and Implementation

Note

Information in the following applications sections is not part of the TI component specification, and TI does not warrant its accuracy or completeness. TI's customers are responsible for determining suitability of components for their purposes, as well as validating and testing their design implementation to confirm system functionality.

10.1 Application Information

This section highlights some of the design considerations when implementing this device in various applications.

10.2 Typical Application

This typical application demonstrates how the TPS22950x device can be used to set an adjustable current limit.

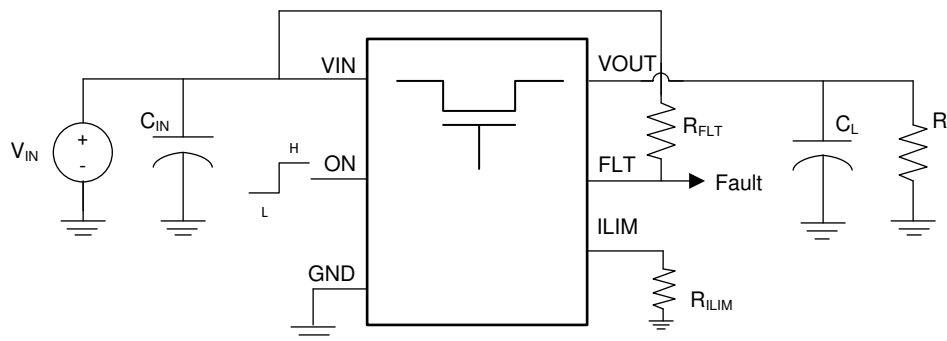

Figure 10-1. Typical Application

10.2.1 Design Requirements

For this example, the values below are used as the design parameters.

Table 10-1. Design Parameters

PARAMETER	VALUE
Input Voltage (V_{IN})	5 V
Load Current (mA)	100 mA
Typical Current Limit (mA)	500 mA

10.2.2 Detailed Design Procedure

In this example the nominal load current is 100 mA, so the current limit can be set to 500 mA without disrupting normal operation. Use Equation 4 to calculate the resistor needed on the ILIM pin.

$$I_{LIM} = 1.18 \times (R_{ILIM})^{-1.072} \quad (4)$$

where

- I_{LIM} = Typical current limit setting
- R_{ILIM} = Resistor on the ILIM pin

Based on Equation 4, a 2.21-k Ω resistor must be used on the ILIM pin to set a typical current limit of 500 mA.

10.2.3 Application Curves

The below scope shot shows the device turning on into a fault condition and limiting the current to the specified amount of 500 mA.

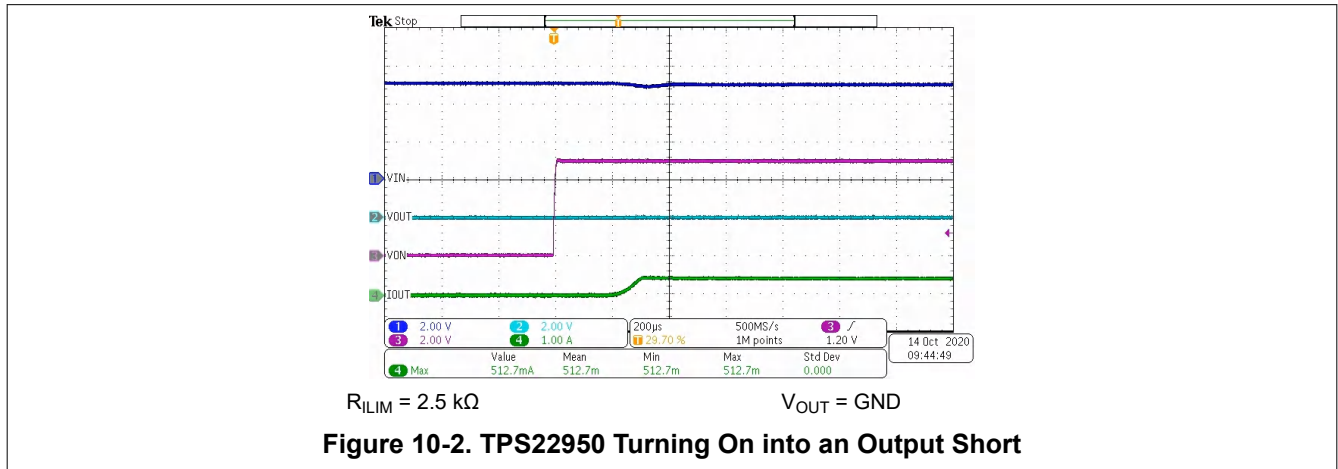

11 Power Supply Recommendations

The device is designed to operate with a VIN range of 1.8 V to 5.5 V. The VIN power supply must be well regulated and placed as close to the device terminal as possible. The power supply must be able to withstand all transient load current steps. In most situations, using an input capacitance (CIN) of 1 μ F is sufficient to prevent the supply voltage from dipping when the switch is turned on. In cases where the power supply is slow to respond to a large transient current or large load current step, additional bulk capacitance may be required on the input.

12 Layout

12.1 Layout Guidelines

For best performance, all traces must be as short as possible. To be most effective, the input and output capacitors must be placed close to the device to minimize the effects that parasitic trace inductances may have on normal operation. Using wide traces for VIN, VOUT, and GND helps minimize the parasitic electrical effects.

12.2 Layout Example

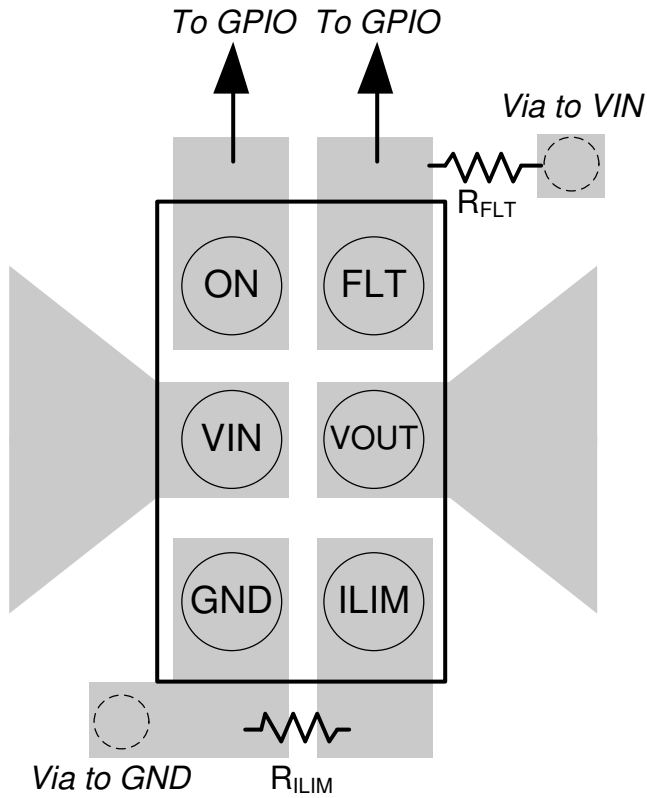

Figure 12-1. TPS22950x Layout Example

13 Device and Documentation Support

TI offers an extensive line of development tools. Tools and software to evaluate the performance of the device, generate code, and develop solutions are listed below.

13.1 Receiving Notification of Documentation Updates

To receive notification of documentation updates, navigate to the device product folder on ti.com. Click on *Subscribe to updates* to register and receive a weekly digest of any product information that has changed. For change details, review the revision history included in any revised document.

13.2 Support Resources

[TI E2E™ support forums](#) are an engineer's go-to source for fast, verified answers and design help — straight from the experts. Search existing answers or ask your own question to get the quick design help you need.

Linked content is provided "AS IS" by the respective contributors. They do not constitute TI specifications and do not necessarily reflect TI's views; see TI's [Terms of Use](#).

13.3 Trademarks

TI E2E™ is a trademark of Texas Instruments.

All trademarks are the property of their respective owners.

13.4 Electrostatic Discharge Caution



This integrated circuit can be damaged by ESD. Texas Instruments recommends that all integrated circuits be handled with appropriate precautions. Failure to observe proper handling and installation procedures can cause damage.

ESD damage can range from subtle performance degradation to complete device failure. Precision integrated circuits may be more susceptible to damage because very small parametric changes could cause the device not to meet its published specifications.

13.5 Glossary

[TI Glossary](#) This glossary lists and explains terms, acronyms, and definitions.

14 Mechanical, Packaging, and Orderable Information

The following pages include mechanical, packaging, and orderable information. This information is the most current data available for the designated devices. This data is subject to change without notice and revision of this document. For browser-based versions of this data sheet, refer to the left-hand navigation.

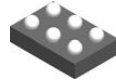

YBH0006-C02

PACKAGE OUTLINE

DSBGA - 0.4 mm max height

DIE SIZE BALL GRID ARRAY

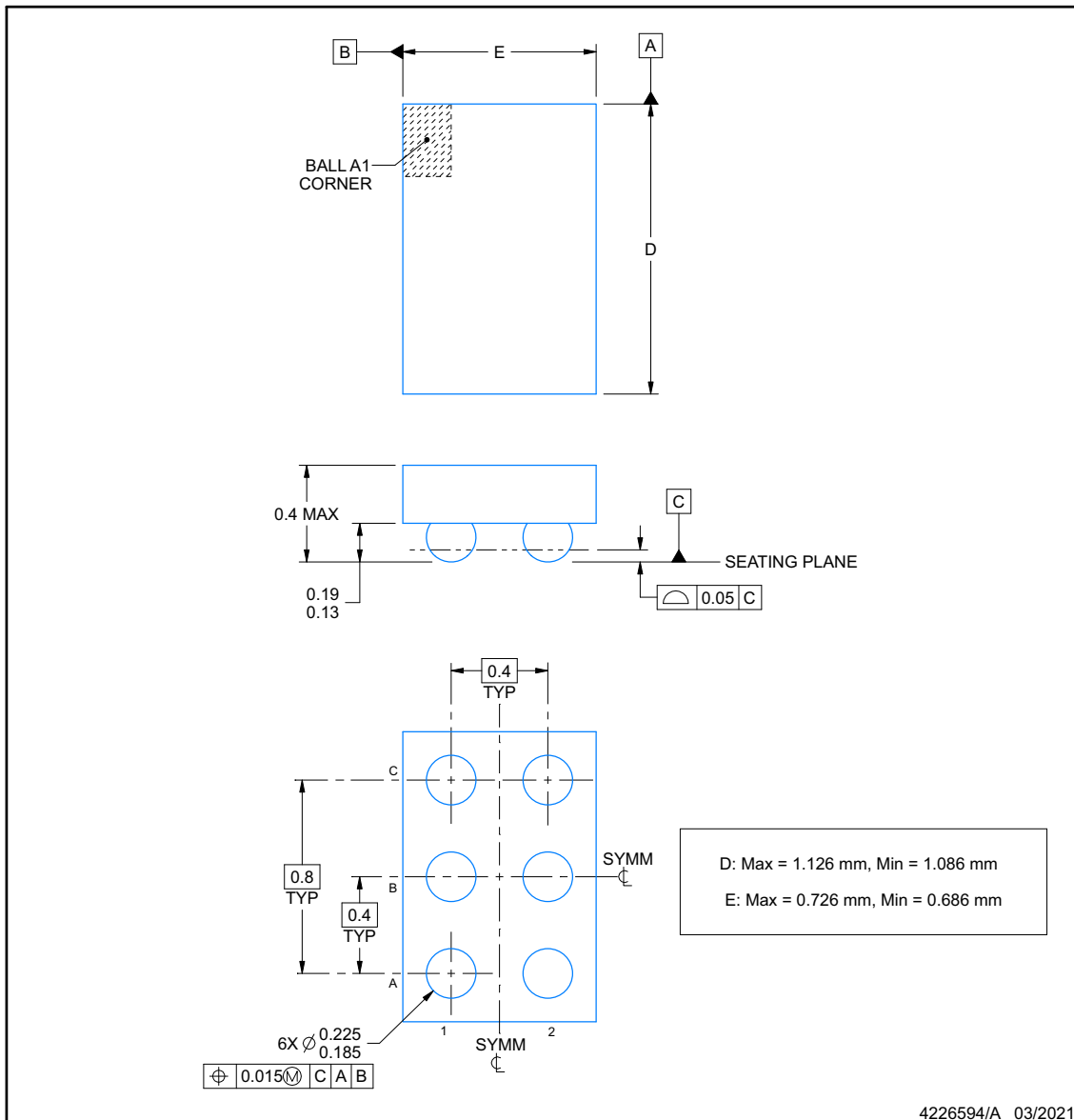

NOTES:

1. All linear dimensions are in millimeters. Any dimensions in parenthesis are for reference only. Dimensioning and tolerancing per ASME Y14.5M.
2. This drawing is subject to change without notice.

EXAMPLE BOARD LAYOUT

YBH0006-C02

DSBGA - 0.4 mm max height

DIE SIZE BALL GRID ARRAY

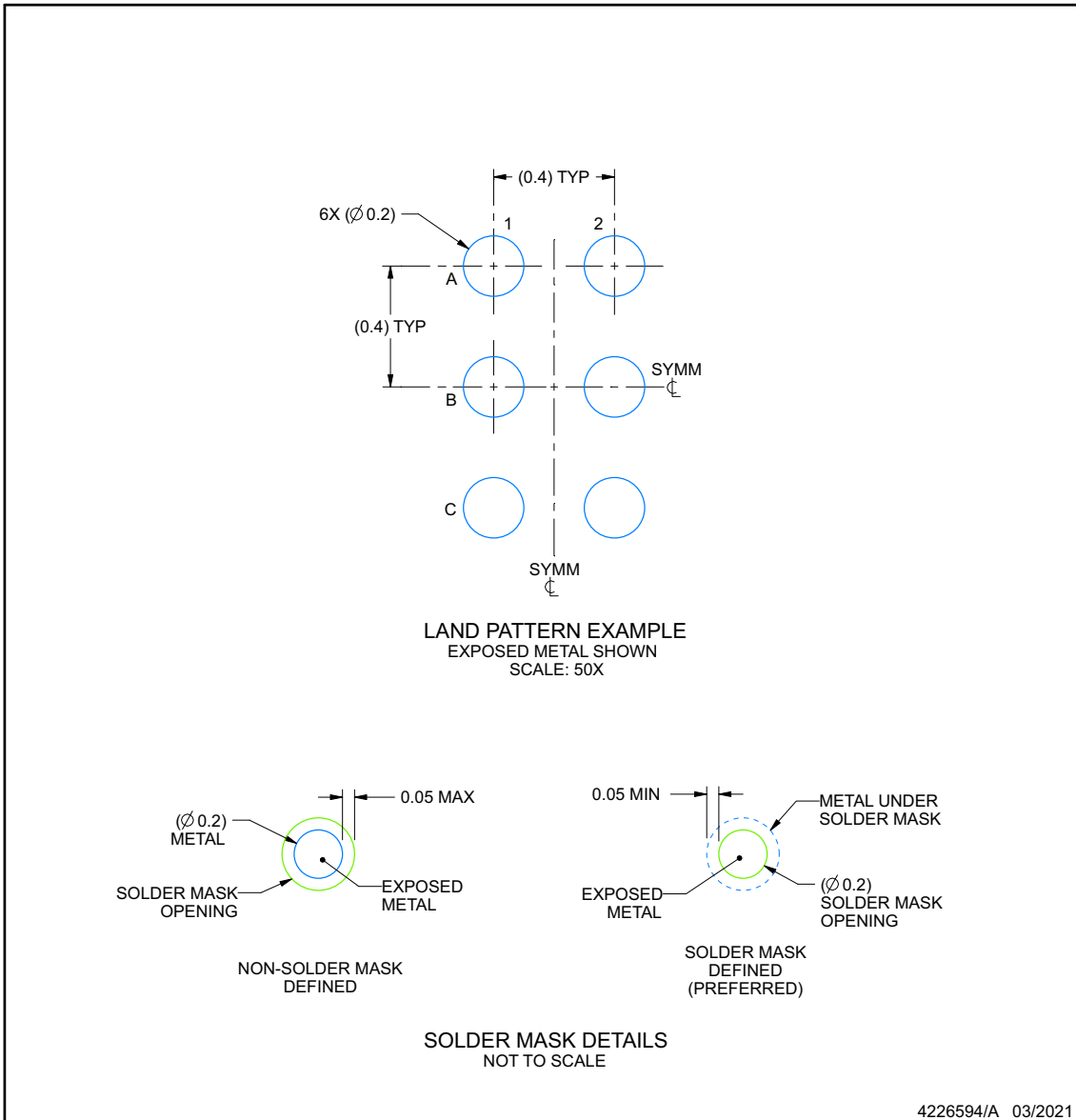

NOTES: (continued)

- Final dimensions may vary due to manufacturing tolerance considerations and also routing constraints. See Texas Instruments Literature No. SNVA009 (www.ti.com/lit/snva009).

EXAMPLE STENCIL DESIGN

YBH0006-C02

DSBGA - 0.4 mm max height

DIE SIZE BALL GRID ARRAY

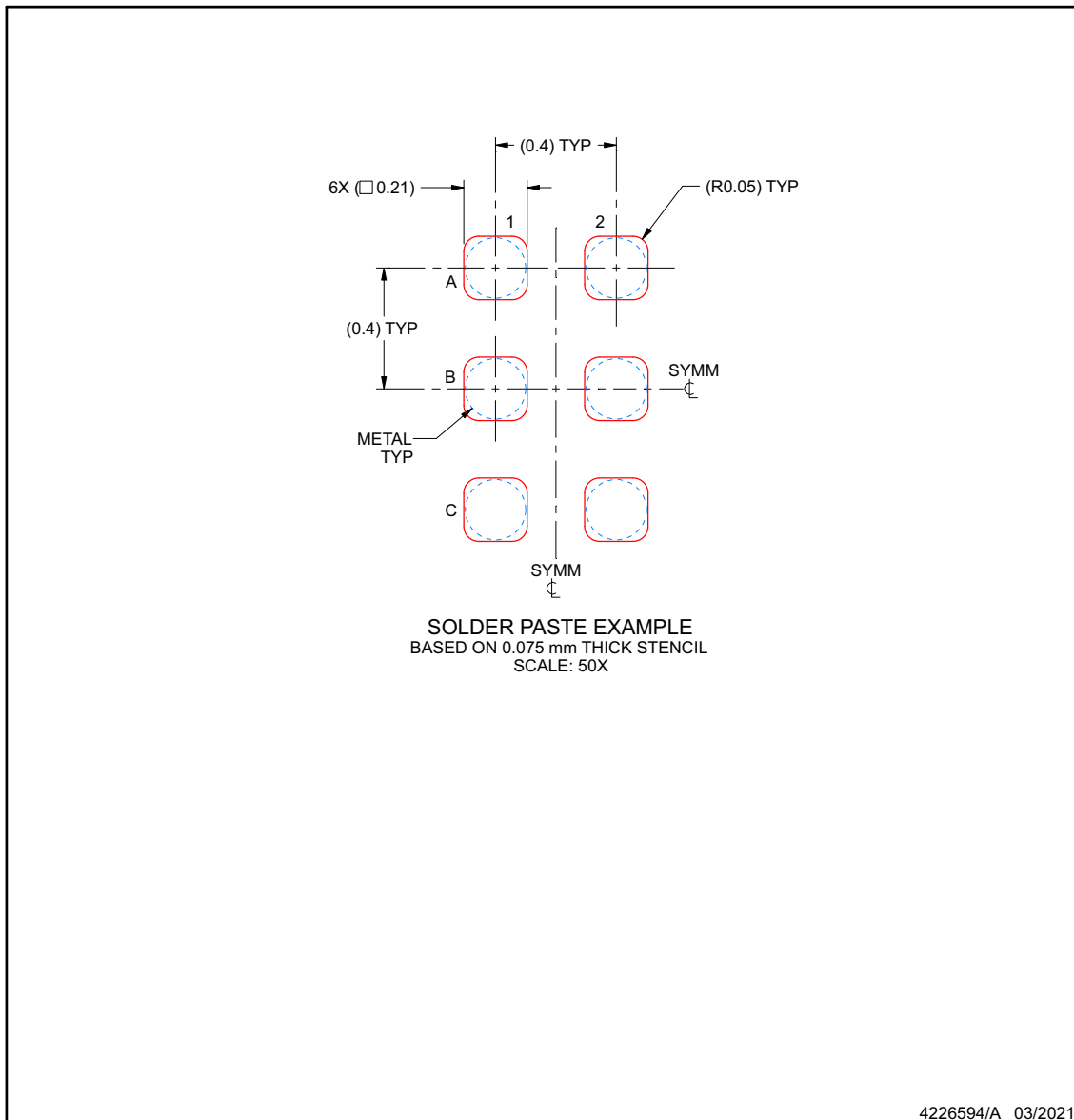

NOTES: (continued)

4. Laser cutting apertures with trapezoidal walls and rounded corners may offer better paste release.

PACKAGING INFORMATION

Orderable Device	Status (1)	Package Type	Package Drawing	Pins	Package Qty	Eco Plan (2)	Lead finish/ Ball material (6)	MSL Peak Temp (3)	Op Temp (°C)	Device Marking (4/5)	Samples
PTPS22950LYBHR	ACTIVE	DSBGA	YBH	6	3000	TBD	Call TI	Call TI	-40 to 125		Samples
TPS22950LYBHR	ACTIVE	DSBGA	YBH	6	3000	RoHS & Green	SNAGCU	Level-1-260C-UNLIM	-40 to 125	4	Samples
TPS22950YBHR	ACTIVE	DSBGA	YBH	6	3000	RoHS & Green	SNAGCU	Level-1-260C-UNLIM	-40 to 125		Samples

(1) The marketing status values are defined as follows:

ACTIVE: Product device recommended for new designs.

LIFEBUY: TI has announced that the device will be discontinued, and a lifetime-buy period is in effect.

NRND: Not recommended for new designs. Device is in production to support existing customers, but TI does not recommend using this part in a new design.

PREVIEW: Device has been announced but is not in production. Samples may or may not be available.

OBsolete: TI has discontinued the production of the device.

(2) **RoHS:** TI defines "RoHS" to mean semiconductor products that are compliant with the current EU RoHS requirements for all 10 RoHS substances, including the requirement that RoHS substance do not exceed 0.1% by weight in homogeneous materials. Where designed to be soldered at high temperatures, "RoHS" products are suitable for use in specified lead-free processes. TI may reference these types of products as "Pb-Free".

RoHS Exempt: TI defines "RoHS Exempt" to mean products that contain lead but are compliant with EU RoHS pursuant to a specific EU RoHS exemption.

Green: TI defines "Green" to mean the content of Chlorine (Cl) and Bromine (Br) based flame retardants meet JS709B low halogen requirements of <=1000ppm threshold. Antimony trioxide based flame retardants must also meet the <=1000ppm threshold requirement.

(3) MSL, Peak Temp. - The Moisture Sensitivity Level rating according to the JEDEC industry standard classifications, and peak solder temperature.

(4) There may be additional marking, which relates to the logo, the lot trace code information, or the environmental category on the device.

(5) Multiple Device Markings will be inside parentheses. Only one Device Marking contained in parentheses and separated by a "~" will appear on a device. If a line is indented then it is a continuation of the previous line and the two combined represent the entire Device Marking for that device.

(6) Lead finish/Ball material - Orderable Devices may have multiple material finish options. Finish options are separated by a vertical ruled line. Lead finish/Ball material values may wrap to two lines if the finish value exceeds the maximum column width.

Important Information and Disclaimer: The information provided on this page represents TI's knowledge and belief as of the date that it is provided. TI bases its knowledge and belief on information provided by third parties, and makes no representation or warranty as to the accuracy of such information. Efforts are underway to better integrate information from third parties. TI has taken and continues to take reasonable steps to provide representative and accurate information but may not have conducted destructive testing or chemical analysis on incoming materials and chemicals. TI and TI suppliers consider certain information to be proprietary, and thus CAS numbers and other limited information may not be available for release.

In no event shall TI's liability arising out of such information exceed the total purchase price of the TI part(s) at issue in this document sold by TI to Customer on an annual basis.

TAPE AND REEL INFORMATION

QUADRANT ASSIGNMENTS FOR PIN 1 ORIENTATION IN TAPE

*All dimensions are nominal

Device	Package Type	Package Drawing	Pins	SPQ	Reel Diameter (mm)	Reel Width W1 (mm)	A0 (mm)	B0 (mm)	K0 (mm)	P1 (mm)	W (mm)	Pin1 Quadrant
TPS22950LYBHR	DSBGA	YBH	6	3000	180.0	8.4	0.8	1.21	0.43	2.0	8.0	Q1
TPS22950YBHR	DSBGA	YBH	6	3000	180.0	8.4	0.8	1.21	0.43	2.0	8.0	Q1

TAPE AND REEL BOX DIMENSIONS

*All dimensions are nominal

Device	Package Type	Package Drawing	Pins	SPQ	Length (mm)	Width (mm)	Height (mm)
TPS22950LYBHR	DSBGA	YBH	6	3000	182.0	182.0	20.0
TPS22950YBHR	DSBGA	YBH	6	3000	182.0	182.0	20.0

IMPORTANT NOTICE AND DISCLAIMER

TI PROVIDES TECHNICAL AND RELIABILITY DATA (INCLUDING DATA SHEETS), DESIGN RESOURCES (INCLUDING REFERENCE DESIGNS), APPLICATION OR OTHER DESIGN ADVICE, WEB TOOLS, SAFETY INFORMATION, AND OTHER RESOURCES "AS IS" AND WITH ALL FAULTS, AND DISCLAIMS ALL WARRANTIES, EXPRESS AND IMPLIED, INCLUDING WITHOUT LIMITATION ANY IMPLIED WARRANTIES OF MERCHANTABILITY, FITNESS FOR A PARTICULAR PURPOSE OR NON-INFRINGEMENT OF THIRD PARTY INTELLECTUAL PROPERTY RIGHTS.

These resources are intended for skilled developers designing with TI products. You are solely responsible for (1) selecting the appropriate TI products for your application, (2) designing, validating and testing your application, and (3) ensuring your application meets applicable standards, and any other safety, security, regulatory or other requirements.

These resources are subject to change without notice. TI grants you permission to use these resources only for development of an application that uses the TI products described in the resource. Other reproduction and display of these resources is prohibited. No license is granted to any other TI intellectual property right or to any third party intellectual property right. TI disclaims responsibility for, and you will fully indemnify TI and its representatives against, any claims, damages, costs, losses, and liabilities arising out of your use of these resources.

TI's products are provided subject to [TI's Terms of Sale](#) or other applicable terms available either on ti.com or provided in conjunction with such TI products. TI's provision of these resources does not expand or otherwise alter TI's applicable warranties or warranty disclaimers for TI products.

TI objects to and rejects any additional or different terms you may have proposed.

Mailing Address: Texas Instruments, Post Office Box 655303, Dallas, Texas 75265
Copyright © 2022, Texas Instruments Incorporated