

Features

- Quad TVS in Common Anode Configuration
- Ultra-Small Surface Mount Package
- Ideal for Transient Suppression and ESD Protection
- **Totally Lead-Free & Fully RoHS Compliant (Notes 1 & 2)**
- **Halogen and Antimony Free. "Green" Device (Note 3)**
- **For automotive applications requiring specific change control (i.e.: parts qualified to AEC-Q100/101/200, PPAP capable, and manufactured in IATF 16949 certified facilities), please refer to the related automotive grade (Q-suffix) part. A listing can be found at <https://www.diodes.com/products/automotive/automotive-products/>.**
- This part is qualified to JEDEC standards (as references in AEC-Q) for High Reliability. <https://www.diodes.com/quality/product-definitions/>

Mechanical Data

- Case: SOT553
- Case Material: Molded Plastic, "Green" Molding Compound. UL Flammability Classification Rating 94V-0
- Moisture Sensitivity: Level 1 per J-STD-020
- Terminal Finish: Matte Tin, Annealed Over Copper Leadframe. Solderable per MIL-STD-202, Method 208 (Ⓜ3)
- Weight: 0.002 grams (Approximate)



SOT553

Top View

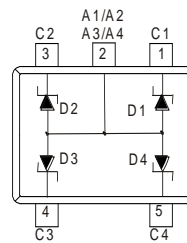

Device Schematic

Ordering Information (Note 4)

| Part Number | Compliance | Case | Packaging |
|---------------|------------|--------|-------------------|
| DZQA5V6AXV5-7 | Standard | SOT553 | 3,000/Tape & Reel |

- Notes:
1. No purposely added lead. Fully EU Directive 2002/95/EC (RoHS), 2011/65/EU (RoHS 2) & 2015/863/EU (RoHS 3) compliant.
 2. See <https://www.diodes.com/quality/lead-free/> for more information about Diodes Incorporated's definitions of Halogen- and Antimony-free, "Green" and Lead-free.
 3. Halogen- and Antimony-free "Green" products are defined as those which contain <900ppm bromine, <900ppm chlorine (<1500ppm total Br + Cl) and <1000ppm antimony compounds.
 4. For packaging details, go to our website at <https://www.diodes.com/design/support/packaging/diodes-packaging/>.

Marking Information

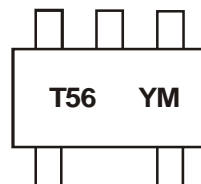

T56 = Product Type Marking Code
 YM = Date Code Marking
 Y = Year (ex: H = 2020)
 M = Month (ex: 9 = September)

Date Code Key

| Year | 2008 | ... | 2020 | 2021 | 2022 | 2023 | 2024 | 2025 | 2026 | 2027 | 2028 | 2029 |
|------|------|-----|------|------|------|------|------|------|------|------|------|------|
| Code | V | ... | H | I | J | K | L | M | N | O | P | R |

| Month | Jan | Feb | Mar | Apr | May | Jun | Jul | Aug | Sep | Oct | Nov | Dec |
|-------|-----|-----|-----|-----|-----|-----|-----|-----|-----|-----|-----|-----|
| Code | 1 | 2 | 3 | 4 | 5 | 6 | 7 | 8 | 9 | O | N | D |

Maximum Ratings (@T_A = +25°C, unless otherwise specified.)

| Characteristic | Symbol | Value | Unit |
|---|----------------|-------|------|
| Forward Voltage @ I _F = 10mA | V _F | 0.9 | V |

Thermal Characteristics

| Characteristic | Symbol | Value | Unit |
|--|-----------------------------------|-------------|------|
| Power Dissipation (Notes 5 & 6) | P _D | 380 | mW |
| Peak Power Dissipation, 8x20μS Waveform (Note 7) | P _{PK} | 20 | W |
| Thermal Resistance, Junction to Ambient (Note 5) | R _{θJA} | 327 | °C/W |
| Operating and Storage Temperature Range | T _J , T _{STG} | -55 to +150 | °C |

Electrical Characteristics (@T_A = +25°C, unless otherwise specified.)

| Type Number | Marking Code | Breakdown Voltage (Note 8) | | | Leakage Current (Note 8) | | Max. Clamping Voltage (Note 7) | | Capacitance @ 0V Bias (pF) (Note 9) | | Capacitance @ 3V Bias (pF) (Note 9) | |
|-------------|--------------|--|---------|---------|-----------------------------------|-----|----------------------------------|---------------------|-------------------------------------|-----|-------------------------------------|------|
| | | V _{BR} @ I _T = 1mA | | | I _{RM} @ V _{RM} | | V _C @ I _{PP} | | C _T | | C _T | |
| | | Min (V) | Nom (V) | Max (V) | Max (μA) | (V) | V _C (V) | I _{PP} (A) | Typ | Max | Typ | Max |
| DZQA5V6AXV5 | T56 | 5.3 | 5.6 | 5.9 | 1 | 3.0 | 13 | 1.6 | 18.7 | 20 | 11.4 | 12.3 |

- Notes:
- Device mounted on FR-4 PCB, 1 inch x 0.85 inch x 0.062 inch; pad layout as shown on Diodes Incorporated's Suggested Pad Layout document, which can be found on our website at <http://www.diodes.com>.
 - Only 1 diode under power. For all 4 diodes under power, P_D will be 25% of the listed value.
 - Non-repetitive current pulse per Figure 2 and derate above T_A = +25°C per Figure 1.
 - Short duration pulse test used to minimize self-heating effect.
 - Per element, f = 1MHz, T_A = +25°C

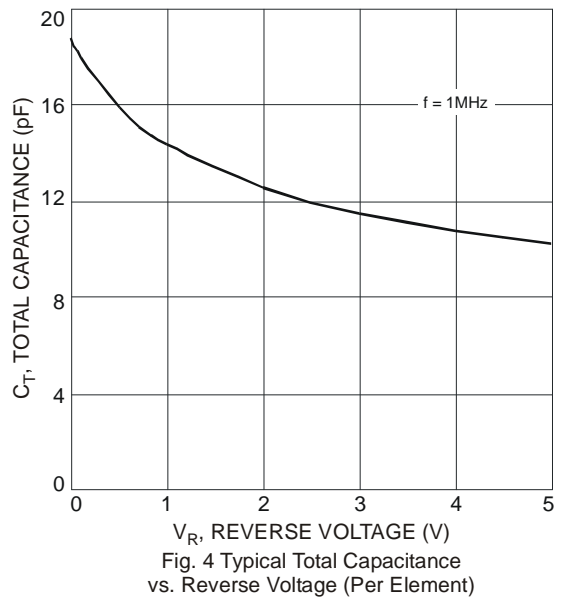
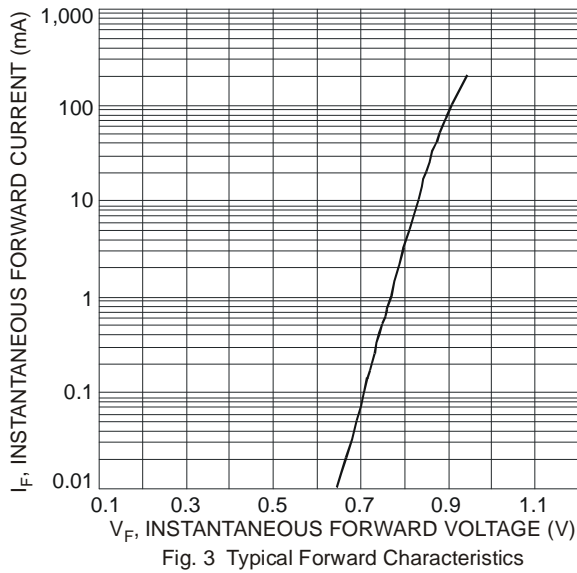
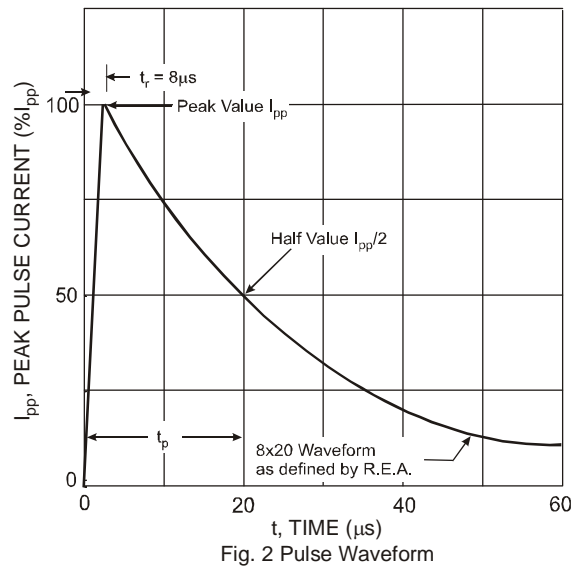
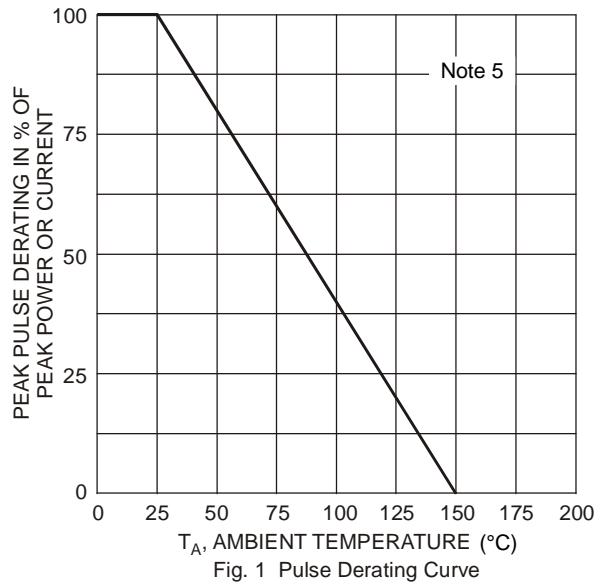

Package Outline Dimensions

Please see <http://www.diodes.com/package-outlines.html> for the latest version.

SOT553

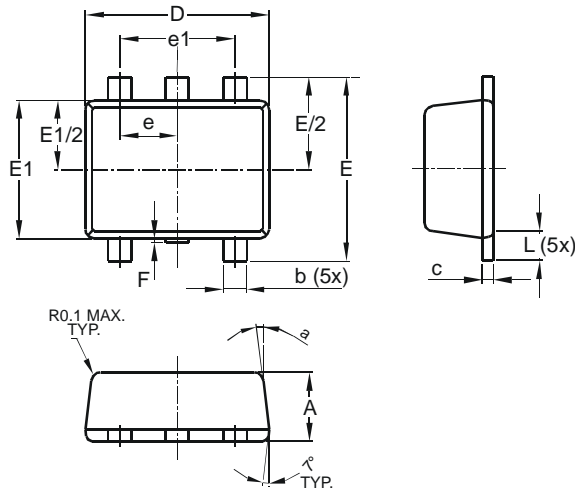

| SOT553 | | | |
|----------------------|----------|------|------|
| Dim | Min | Max | Typ |
| A | 0.55 | 0.62 | 0.60 |
| b | 0.15 | 0.30 | 0.20 |
| c | 0.10 | 0.18 | 0.15 |
| D | 1.50 | 1.70 | 1.60 |
| E | 1.55 | 1.70 | 1.60 |
| E1 | 1.10 | 1.25 | 1.20 |
| e | 0.50 BSC | | |
| e1 | 1.00 BSC | | |
| F | 0.00 | 0.10 | — |
| L | 0.10 | 0.30 | 0.20 |
| a | 6° | 8° | 7° |
| All Dimensions in mm | | | |

Suggested Pad Layout

Please see <http://www.diodes.com/package-outlines.html> for the latest version.

SOT553

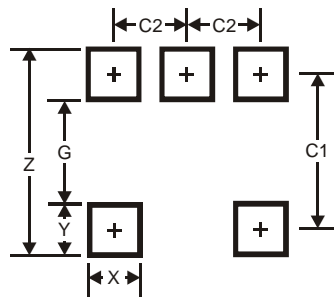

| Dimensions | Value (in mm) |
|------------|---------------|
| Z | 2.2 |
| G | 1.2 |
| X | 0.375 |
| Y | 0.5 |
| C1 | 1.7 |
| C2 | 0.5 |

IMPORTANT NOTICE

DIODES INCORPORATED MAKES NO WARRANTY OF ANY KIND, EXPRESS OR IMPLIED, WITH REGARDS TO THIS DOCUMENT, INCLUDING, BUT NOT LIMITED TO, THE IMPLIED WARRANTIES OF MERCHANTABILITY AND FITNESS FOR A PARTICULAR PURPOSE (AND THEIR EQUIVALENTS UNDER THE LAWS OF ANY JURISDICTION).

Diodes Incorporated and its subsidiaries reserve the right to make modifications, enhancements, improvements, corrections or other changes without further notice to this document and any product described herein. Diodes Incorporated does not assume any liability arising out of the application or use of this document or any product described herein; neither does Diodes Incorporated convey any license under its patent or trademark rights, nor the rights of others. Any Customer or user of this document or products described herein in such applications shall assume all risks of such use and will agree to hold Diodes Incorporated and all the companies whose products are represented on Diodes Incorporated website, harmless against all damages.

Diodes Incorporated does not warrant or accept any liability whatsoever in respect of any products purchased through unauthorized sales channel. Should Customers purchase or use Diodes Incorporated products for any unintended or unauthorized application, Customers shall indemnify and hold Diodes Incorporated and its representatives harmless against all claims, damages, expenses, and attorney fees arising out of, directly or indirectly, any claim of personal injury or death associated with such unintended or unauthorized application.

Products described herein may be covered by one or more United States, international or foreign patents pending. Product names and markings noted herein may also be covered by one or more United States, international or foreign trademarks.

This document is written in English but may be translated into multiple languages for reference. Only the English version of this document is the final and determinative format released by Diodes Incorporated.

LIFE SUPPORT

Diodes Incorporated products are specifically not authorized for use as critical components in life support devices or systems without the express written approval of the Chief Executive Officer of Diodes Incorporated. As used herein:

A. Life support devices or systems are devices or systems which:

1. are intended to implant into the body, or
2. support or sustain life and whose failure to perform when properly used in accordance with instructions for use provided in the labeling can be reasonably expected to result in significant injury to the user.

B. A critical component is any component in a life support device or system whose failure to perform can be reasonably expected to cause the failure of the life support device or to affect its safety or effectiveness.

Customers represent that they have all necessary expertise in the safety and regulatory ramifications of their life support devices or systems, and acknowledge and agree that they are solely responsible for all legal, regulatory and safety-related requirements concerning their products and any use of Diodes Incorporated products in such safety-critical, life support devices or systems, notwithstanding any devices- or systems-related information or support that may be provided by Diodes Incorporated. Further, Customers must fully indemnify Diodes Incorporated and its representatives against any damages arising out of the use of Diodes Incorporated products in such safety-critical, life support devices or systems.

Copyright © 2020, Diodes Incorporated

www.diodes.com