

THIS DRAWING IS UNPUBLISHED. RELEASED FOR PUBLICATION 20  
 © COPYRIGHT 20 BY - ALL RIGHT REVERSED ALL RIGHTS RESERVED.

LOC		DIST		REVISIONS			
P	LTR	DESCRIPTION		DATE	DWN	APVD	
B2		ECR-21-108676		03AUG2021	LZ	FL	
C		ECR-21-110755		02SEP2021	KD	FL	
C1		ECR-21-118862		10NOV2021	SM	FL	

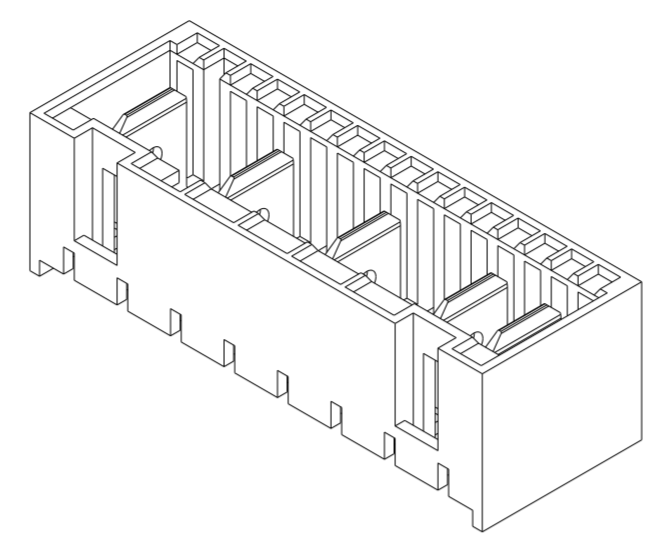

- HOUSING HAS RAST 5 COMPLIANT KEYING LATCHING, AND POLARIZATION, TAB IS 6.30 x 0.8mm ACCORDING TO DIN 46224
- MATERIAL: HOUSING NYLON, UL94 V0, 750 °C GWT NO FLAME
- FINISH: CONTACTS, TIN PLATING OVERALL , NICKEL UNDER-PLATING
- PACKING: LOOSE PIECE OR TUBE. THE PART NUMBER IN THIS DRAWING ARE WITH LOOSE PIECE PACKING. PLEASE CONTACT TE SALES REPRESENTATIVES FOR TUBE PACKING REQUIREMENT.
- PRELIMINARY, NOT FOR PRODUCTION.
- MATERIAL: HOUSING PA66,UL94 V0  
PRODUCT COMPLY WITH GLOW WIRE REQUIREMENTS FOR PARTS OF NON-METALLIC MATERIAL SUPPORTING A CURRENT-CARRYING CONNECTION DETAILED IN IEC 60335-1, SECTION 30 (GWT).
- FINISH:CONTACT, SILVER PLATING OVERALL, NICKEL UNDER-PLATING.
- SPECIAL VERSION: SHORT PEG DESIGN, DETAIL IN SHEET 3
- PART NUMBER WITH TUBE PACKAGING.
- MATERIAL: PA66 GF, UL94 V0, 750°C GWT NO FLAME

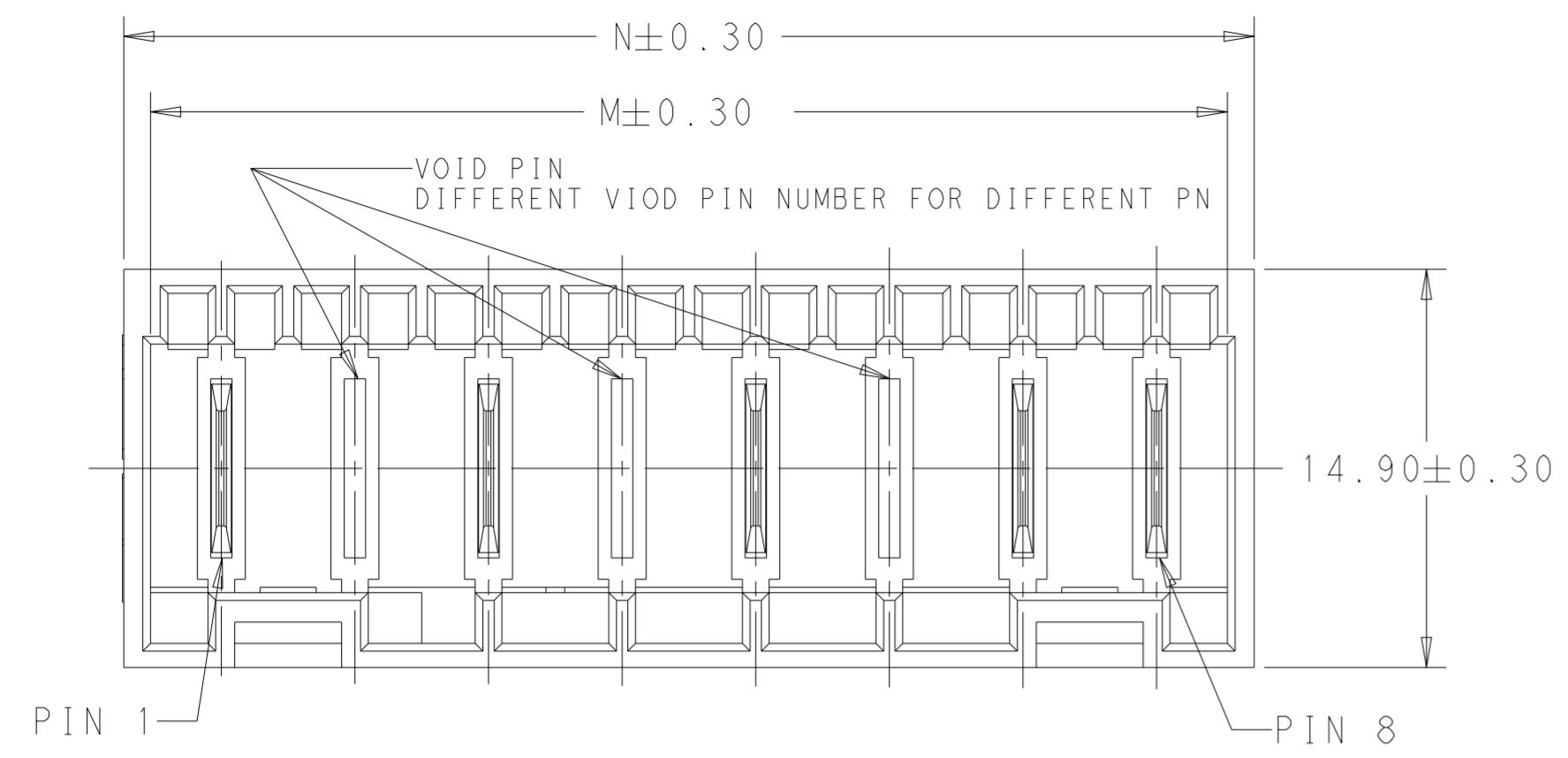
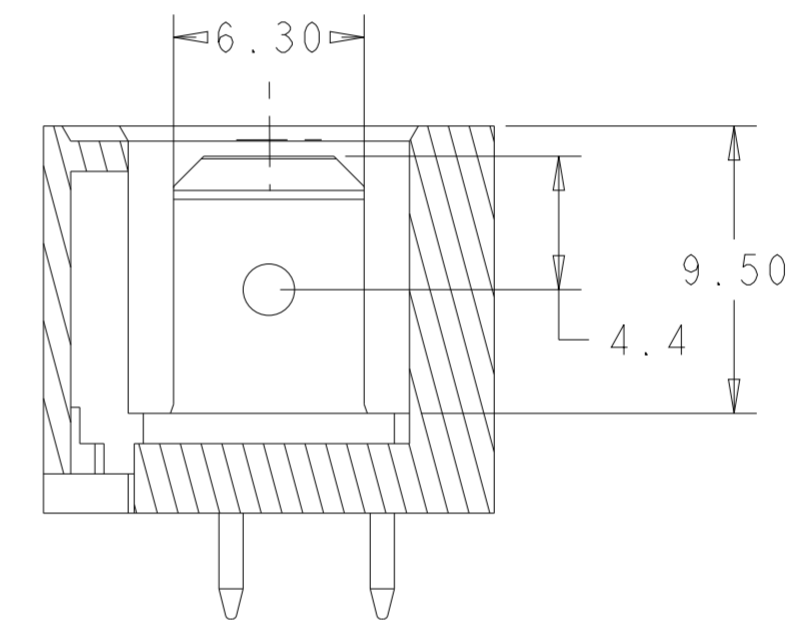
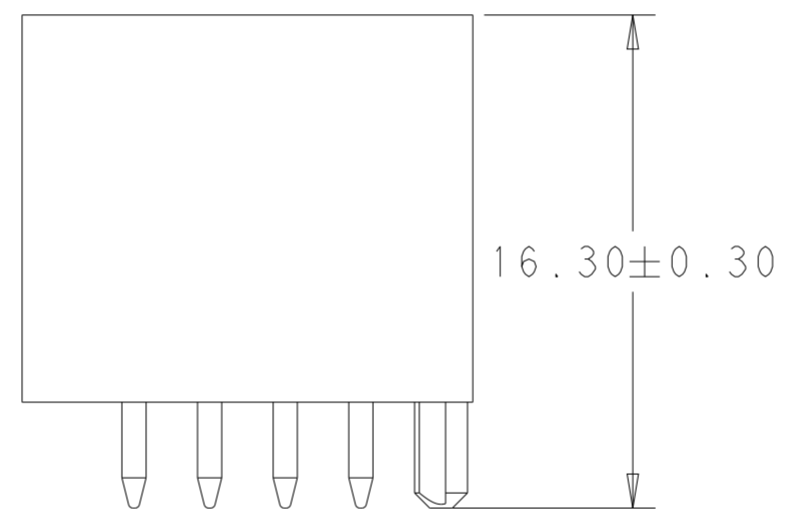
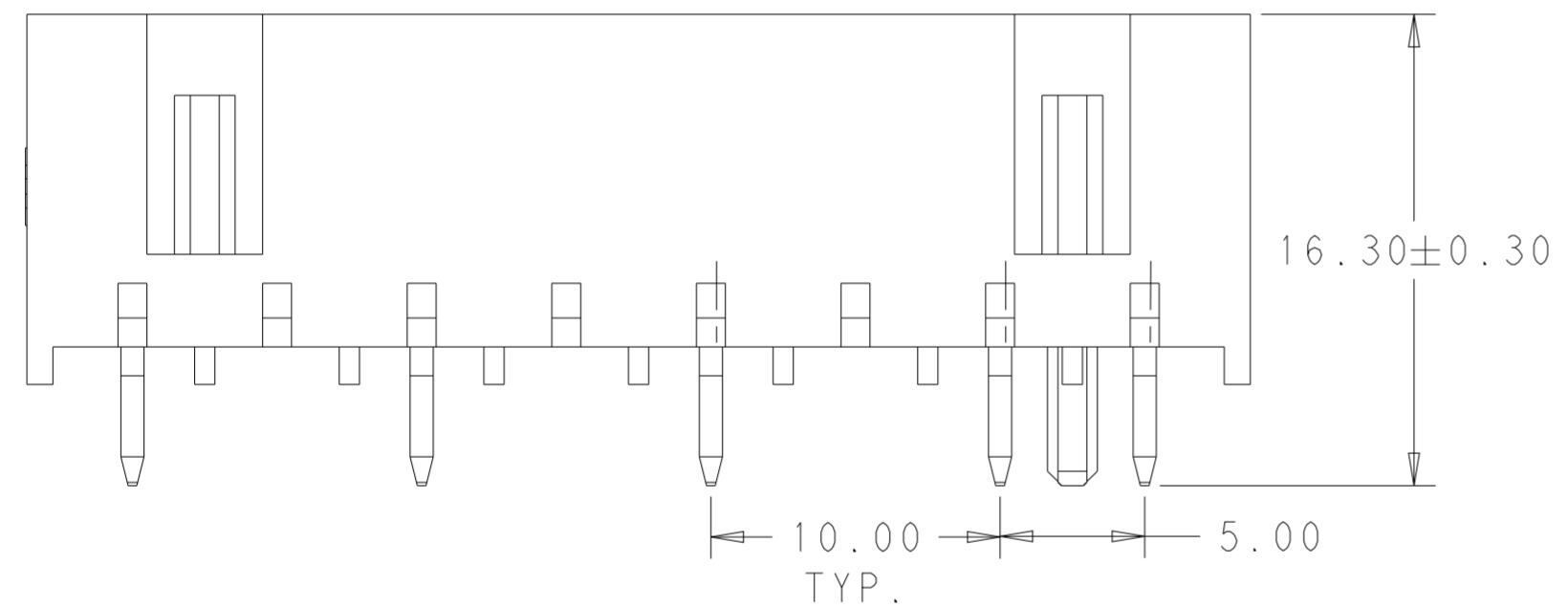

SECTION A-A

TOOL MARK ON TERMINAL SURFACE IS ACCEPTABLE WHICH DOES NOT IMPACT FUNCTION

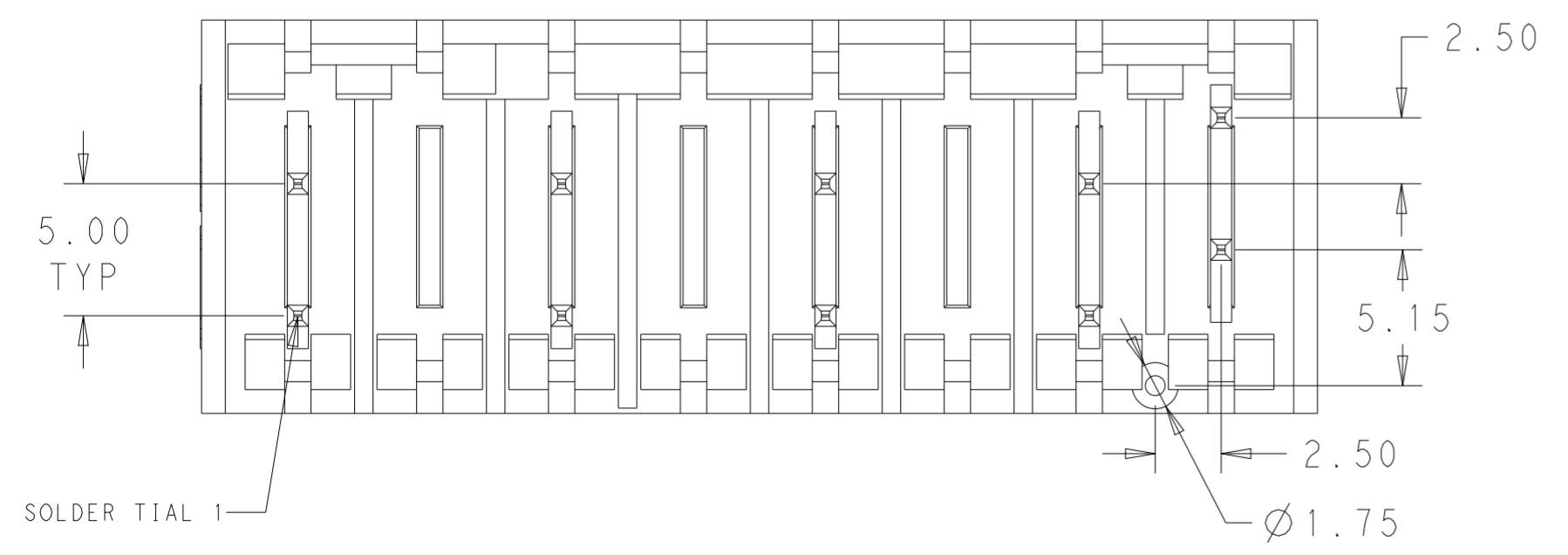

42.30	40.30	8
37.30	35.30	7
32.30	30.30	6
27.30	25.30	5
22.30	20.30	4
17.30	15.30	3
12.30	10.30	2
N	M	NO.OF POS.

THIS DRAWING IS A CONTROLLED DOCUMENT.

DWN	B.P	APR162013
CHK	F.M	APR162013
APVD		APR162013
PRODUCT SPEC	108-106080	
APPLICATION SPEC		
WEIGHT		
CUSTOMER DRAWING	SCALE 4:1	SHEET 1 OF 4

TE Connectivity

NAME RAST 5 TAB HEADER ASSY  
DIN STYLE, TH, VERTICAL

SIZE A2 CAGE CODE 00779 DRAWING NO C-2232511 RESTRICTED TO

REV C1

THIS DRAWING IS UNPUBLISHED. RELEASED FOR PUBLICATION 20  
 © COPYRIGHT 20 BY - ALL RIGHT REVERSED ALL RIGHTS RESERVED.

LOC		DIST		REVISIONS			
P	LTR	DESCRIPTION	DATE	DWN	APVD		
-	-	SEE SHEET 1	-	-	-		

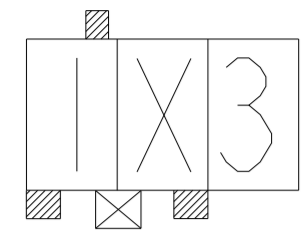

3-2232511-3  $\Delta_5 \Delta_7$

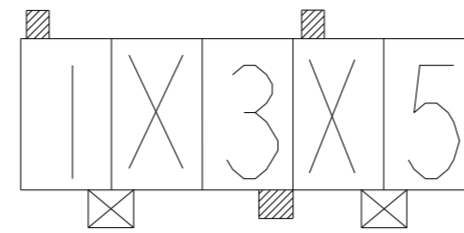

4-2232511-5  $\Delta_9$

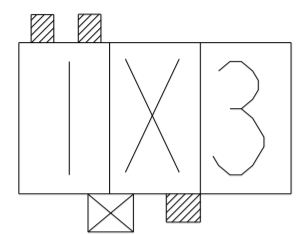

2-2232511-3  $\Delta_5$

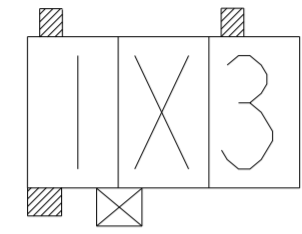

2232511-3  
 1-2232511-3  $\Delta_6$   
 2328608-3  $\Delta_8$

3 POS.

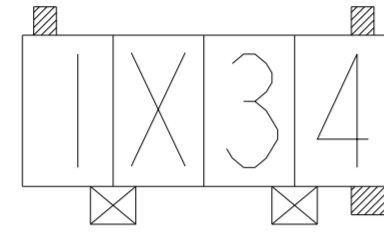

2232511-4

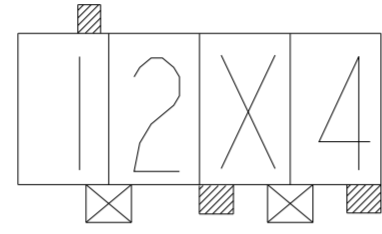

1-2232511-4

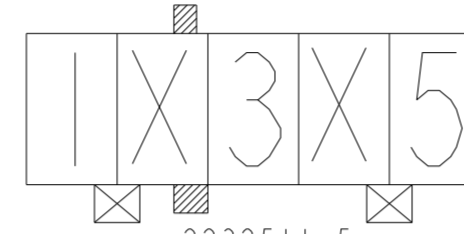

2232511-5  
 1-2232511-5  $\Delta_6$   
 2328608-5  $\Delta_8$

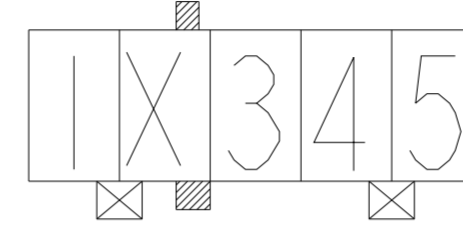

2-2232511-5  $\Delta_5$

5 POS.

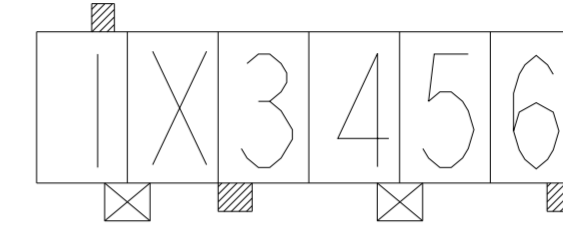

2232511-6

6 POS.

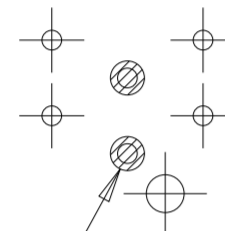

VOID PIN

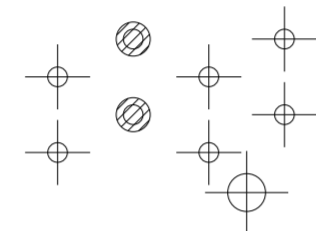

4 POS.

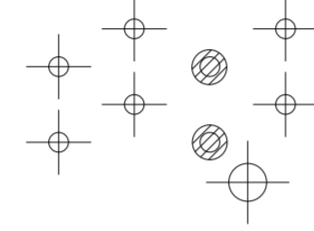

PCB LAYOUT SKETCH  
 SOLDER SIDE

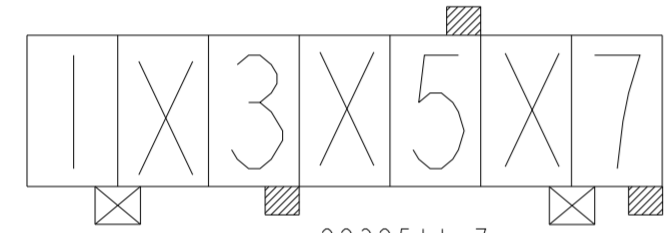
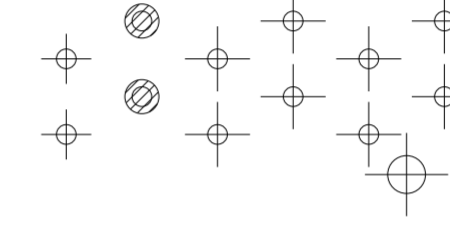
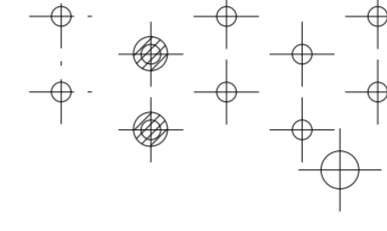
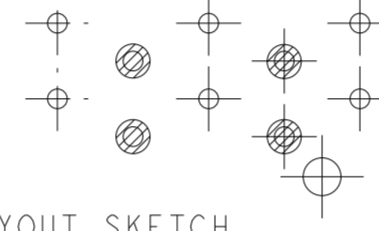

2232511-7  
 1-2232511-7  $\Delta_6$   
 2328608-7  $\Delta_8$

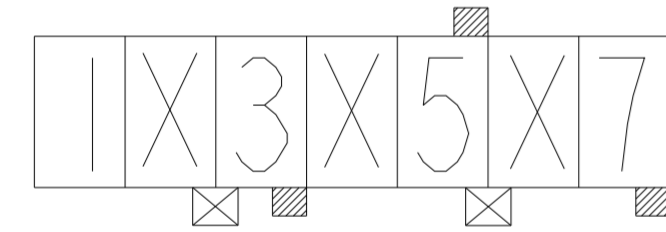

2-2232511-7  $\Delta_6$   
 1-2328608-7  $\Delta_8$

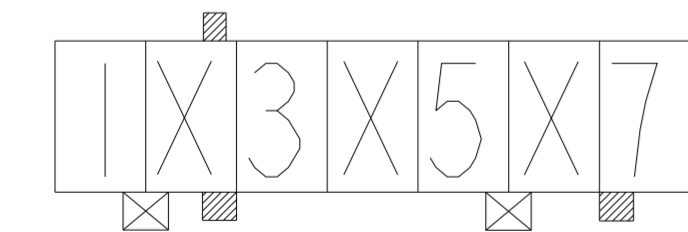

3-2232511-7

7 POS.

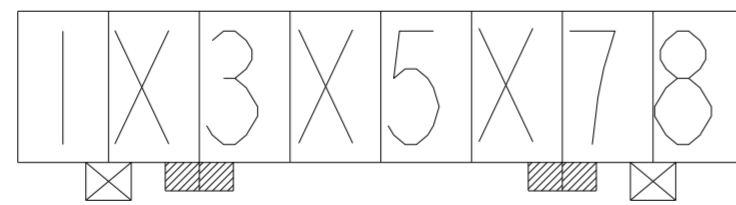

2232511-8

8 POS.

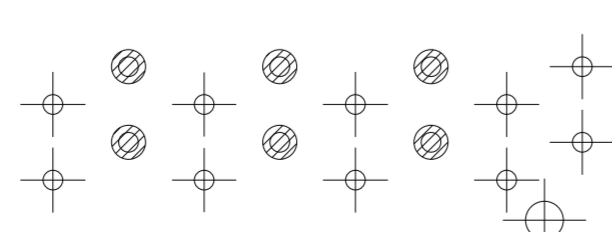
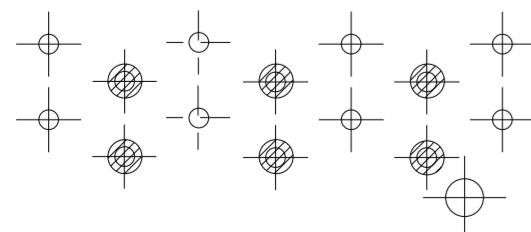

PCB LAYOUT SKETCH  
 SOLDER SIDE

THIS DRAWING IS A CONTROLLED DOCUMENT.		DWN B.P.	APR162013	<b>STE</b> TE Connectivity	
		CHK	24SEP2013		
DIMENSIONS: mm		TOLERANCES UNLESS OTHERWISE SPECIFIED:		NAME RAST 5 TAB HEADER ASSY DIN STYLE, TH, VERTICAL	
		0 PLC ±		APVD 24SEP2013	
		1 PLC ±0.5		PRODUCT SPEC 108-106080	
		2 PLC ±0.13		APPLICATION SPEC	
		3 PLC ±0.013		SIZE A200779	
		4 PLC ±0.0001		CAGE CODE C-2232511	
		ANGLES ±		DRAWING NO	
MATERIAL		FINISH		RESTRICTED TO	
				WEIGHT	
				CUSTOMER DRAWING	
				SCALE 4:1 SHEET 2 OF 4 REV C1	

THIS DRAWING IS UNPUBLISHED. RELEASED FOR PUBLICATION 20  
 © COPYRIGHT 20 BY - ALL RIGHT REVERSED ALL RIGHTS RESERVED.

LOC		DIST		REVISIONS			
P	LTR	DESCRIPTION	DATE	DWN	APVD		
-	-	SEE SHEET 1	-	-	-		

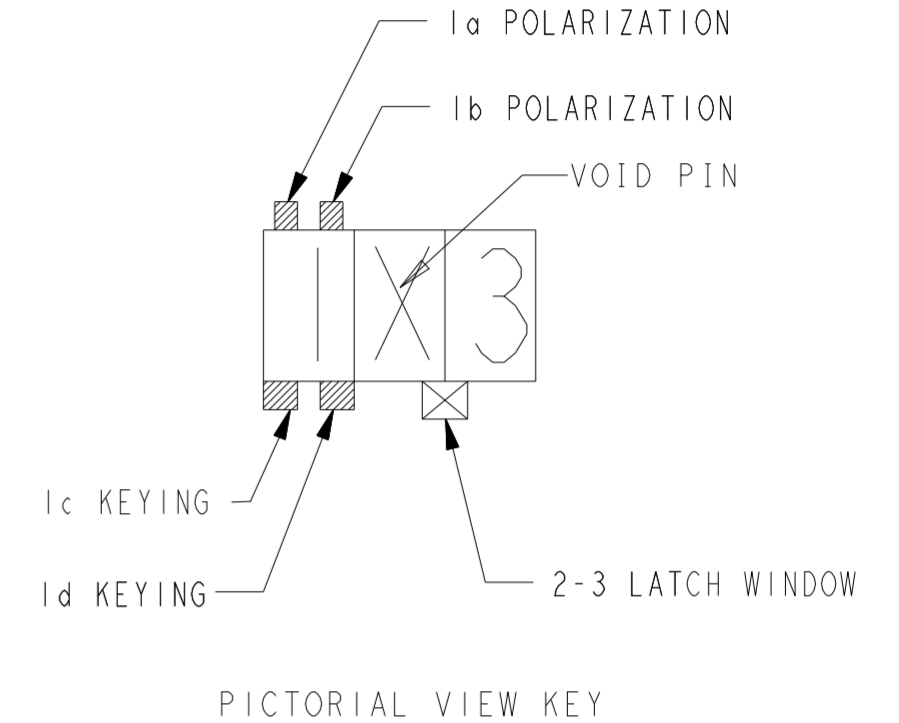
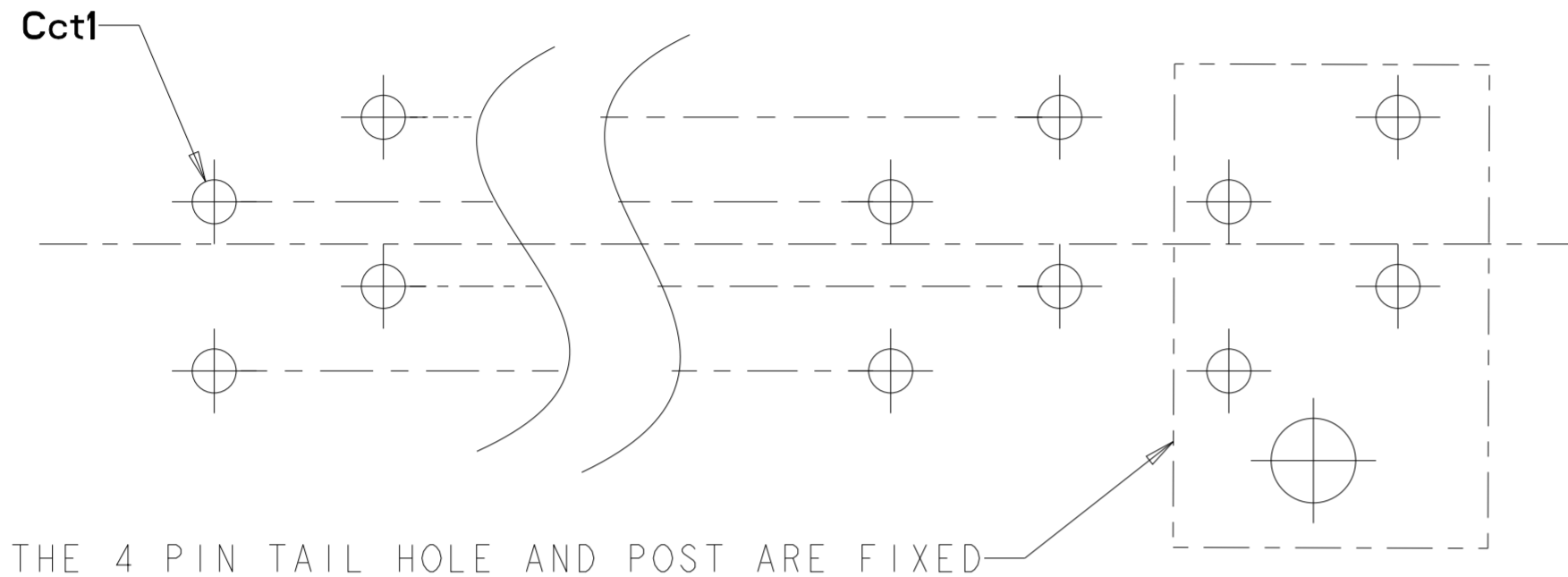

RECOMMEND PCB LAYOUT - SOLDER SIDE  
 PCB 1.5± 0.2 THICK

NATURE	8	2232511-8	
	7	3-2232511-7	
	7	2-2232511-7	6
	7	1-2232511-7	6
	7	2232511-7	
	6	2232511-6	
	5	4-2232511-5	9
	5	2-2232511-5	5
	5	1-2232511-5	6
	5	2232511-5	
	4	1-2232511-4	
	4	2232511-4	5
	3	3-2232511-3	5 7
	3	2-2232511-3	5
	3	1-2232511-3	6
3	2232511-3		
COLOR	NO. OF POS.	PART NUMBER	

THIS DRAWING IS A CONTROLLED DOCUMENT.		DWN B.P.	APR162013	<b>STE</b> TE Connectivity	
		CHK	24SEP2013		
DIMENSIONS: mm		TOLERANCES UNLESS OTHERWISE SPECIFIED:		NAME RAST 5 TAB HEADER ASSY DIN STYLE, TH, VERTICAL	
		0 PLC ±		APVD	
		1 PLC ±0.5		24SEP2013	
		2 PLC ±0.13		PRODUCT SPEC	
		3 PLC ±0.013		108-106080	
		4 PLC ±0.0001		APPLICATION SPEC	
		ANGLES ±		SIZE	
		FINISH		CAGE CODE	
				DRAWING NO	
				RESTRICTED TO	
				A200779C-2232511	
				SCALE 4:1 SHEET 3 OF 4 REV C1	
				CUSTOMER DRAWING	

THIS DRAWING IS UNPUBLISHED. RELEASED FOR PUBLICATION 20  
 © COPYRIGHT 20 BY - ALL RIGHT REVERSED ALL RIGHTS RESERVED.

LOC		DIST		REVISIONS			
P	LTR	DESCRIPTION	DATE	DWN	APVD		
-	-	SEE SHEET 1	-	-	-		

△ SPECIAL VERSION: SHORT PEG DESIGN

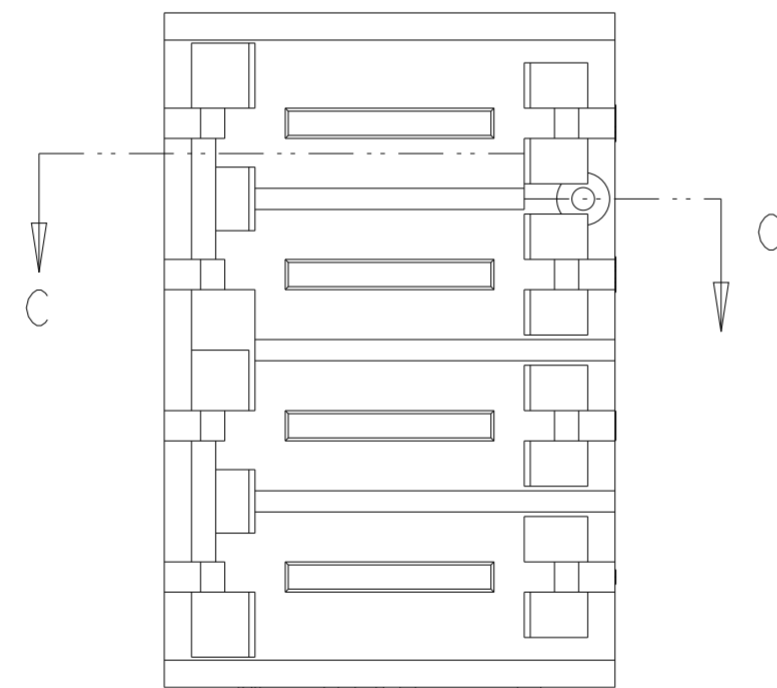
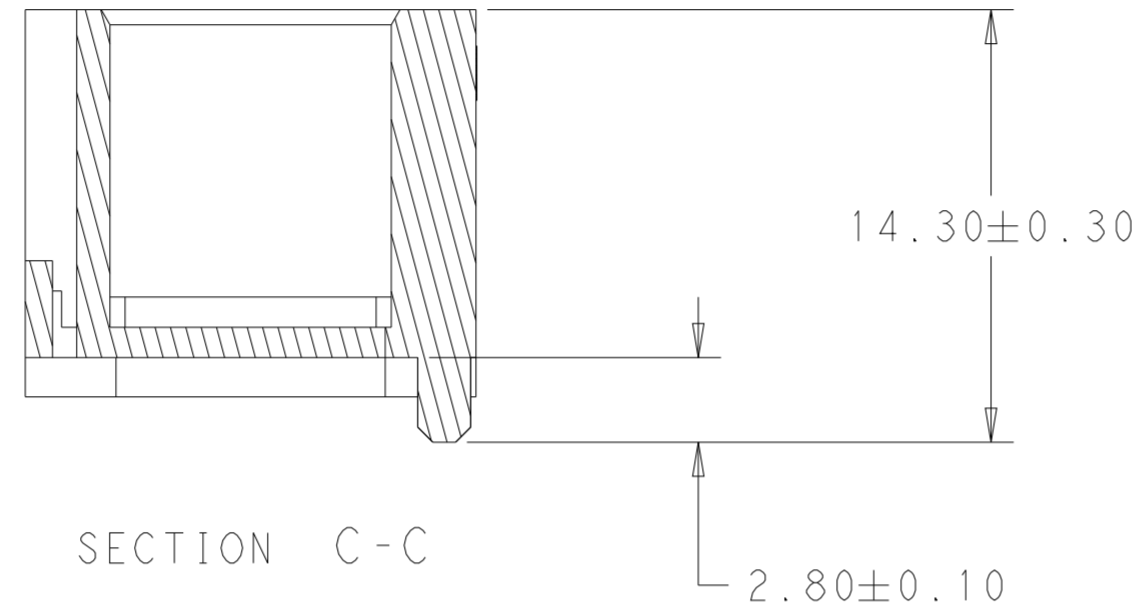

OTHER DIMENSIONS SEE SHEET 1  
 KEYING SEE SHEET 2

NATURE	7	△ 1-2328608-7
	7	2328608-7
	5	2328608-5
	3	2328608-3
COLOR	NO. OF POS.	△ PART NUMBER

DIMENSIONS:		TOLERANCES UNLESS OTHERWISE SPECIFIED:		DWN		APR162013		CHK		APR162013		APVD		APR162013		NAME	
mm	0 PLC ±	1 PLC ±0.5	2 PLC ±0.25	3 PLC ±0.013	4 PLC ±0.0001	ANGLES ±	FINISH	PRODUCT SPEC	108-106080	APPLICATION SPEC	-	SIZE	CAGE CODE	DRAWING NO	RESTRICTED TO		
MATERIAL	-	-	-	-	-	-	-	WEIGHT	-	CUSTOMER DRAWING	SCALE	4:1	SHEET	4 OF 4	REV	C1	



RAST 5 TAB HEADER ASSY  
 DIN STYLE, TH, VERTICAL

A200779 C-2232511