

# NUF6106FCT1

## 6 Channel EMI Pi-Filter Array with ESD Protection

This device is a 6 channel EMI filter array for data lines. Greater than -20 dB attenuation is obtained at frequencies from 800 MHz to 2.2 GHz. It also offers ESD protection – clamping transients from static discharges to protect delicate data line circuitry.

### Features

- EMI Filtering and ESD Protection for Data Lines
- Integration of 30 Discretes Offers Cost and Space Savings
- Exceeds IEC61000-4-2 (Level 4) Specifications
- Low Profile Flip-Chip Packaging
- MSL 1

### Typical Applications

- EMI Filtering and ESD Protection for Data Lines
- Cell Phones
- Handheld Portables
- Notebook Computers
- MP3 Players

### MAXIMUM RATINGS (T<sub>A</sub> = 25°C)

Rating	Symbol	Value	Unit
ESD Discharge IEC61000-4-2, – Contact Discharge Human Body Model Machine Model	V <sub>PP</sub>	8.0 16 1.6	kV
DC Power per Resistor	P <sub>R</sub>	100	mW
DC Power per Package	P <sub>T</sub>	600	mW
Junction Temperature	T <sub>J</sub>	150	°C
Operating Temperature Range	T <sub>Op</sub>	-40 to +85	°C
Storage Temperature Range	T <sub>stg</sub>	-55 to +150	°C



ON Semiconductor®

<http://onsemi.com>

### CIRCUIT DESCRIPTION

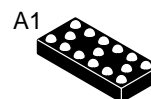
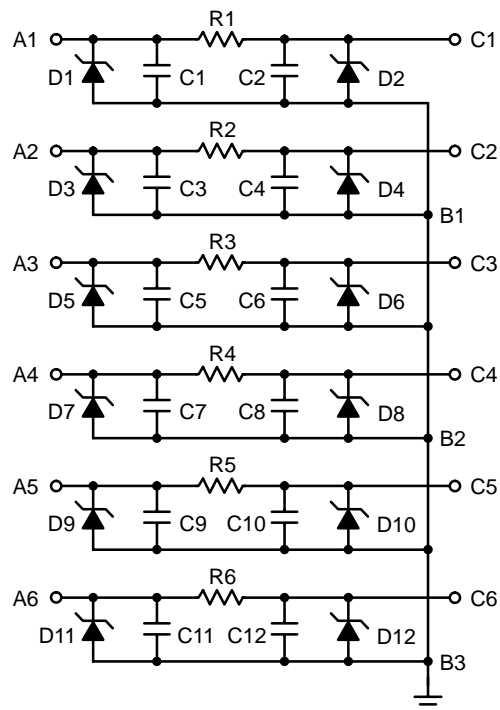

FLIP-CHIP  
CASE 499D  
PLASTIC

### DEVICE MARKING

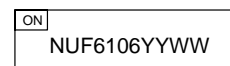

NUF6106= Specific Device Code  
YY = Year  
WW = Work Week

### ORDERING INFORMATION

Device	Package	Shipping†
NUF6106FCT1	Flip-Chip	3000/Tape & Reel

†For information on tape and reel specifications, including part orientation and tape sizes, please refer to our Tape and Reel Packaging Specification Brochure, BRD8011/D.

# NUF6106FCT1

## ELECTRICAL CHARACTERISTICS ( $T_A = 25^\circ\text{C}$ unless otherwise noted)

Symbol	Characteristic	Min	Typ	Max	Unit
$V_{BR}$	$I_Z = 10 \text{ mA}$	6.0	7.0	8.0	V
$I_R$	$V_{RM} = 3.3 \text{ V per line}$	-	-	0.1	$\mu\text{A}$
$R_{I/O}$	$I_R = 20 \text{ mA}$	80	100	120	$\Omega$
$C_{line}$	$V_R = 2.5 \text{ V}, f = 1 \text{ MHz (Note 1)}$	-	21	23	pF

1. Measured from Input/Output Pins to Ground

## TYPICAL PERFORMANCE CURVES

( $T_A = 25^\circ\text{C}$  unless otherwise specified)

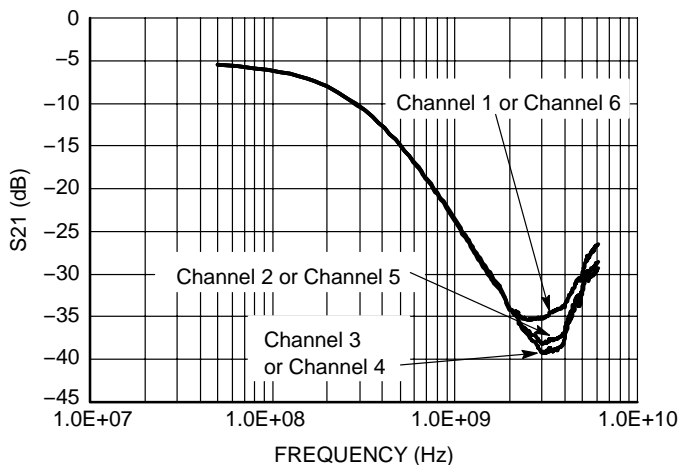

Figure 1. Insertion Loss Characteristics (S21 Measurement)

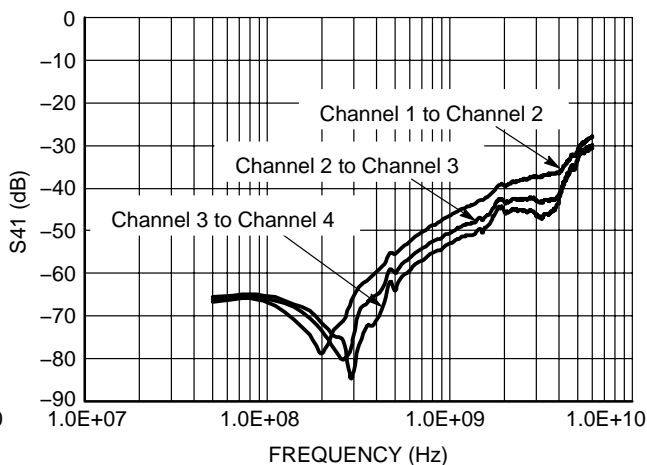

Figure 2. Analog Crosstalk Curve (S41 Measurement)

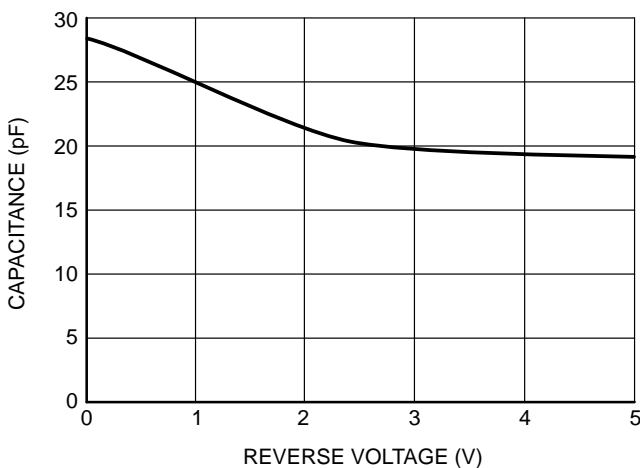

Figure 3. Typical Line Capacitance vs. Reverse Bias Voltage

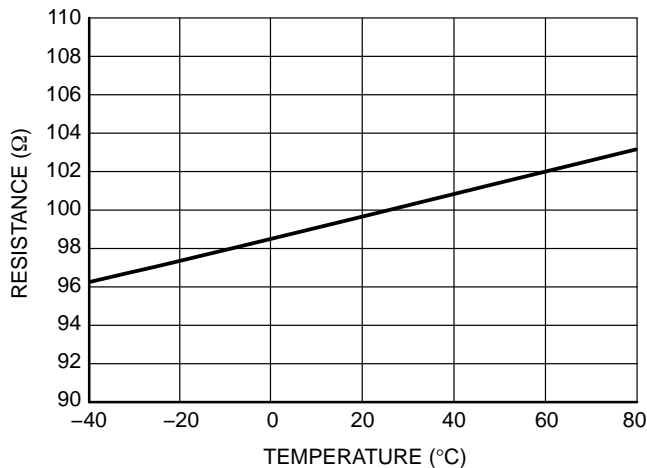

Figure 4. Typical Resistance Over Temperature

# NUF6106FCT1

## Printed Circuit Board Recommendations

Parameter	500 $\mu\text{m}$ Pitch 300 $\mu\text{m}$ Solder Ball
PCB Pad Size	250 $\mu\text{m}$ +25 -0
Pad Shape	Round
Pad Type	NSMD
Solder Mask Opening	350 $\mu\text{m}$ $\pm$ 25
Solder Stencil Thickness	125 $\mu\text{m}$
Stencil Aperture	250 x 250 $\mu\text{m}$ sq.
Solder Flux Ratio	50/50
Solder Paste Type	No Clean Type 3 or Finer
Trace Finish	OSP Cu
Trace Width	150 $\mu\text{m}$ Max

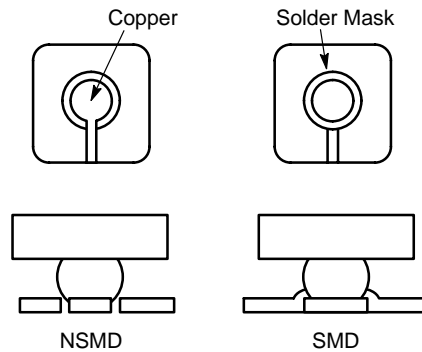

Figure 5. Solder Mask versus Non-Solder Mask Definition

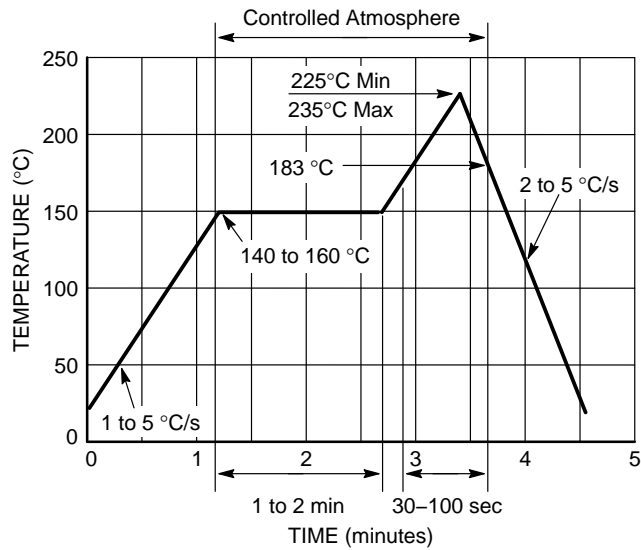

Figure 6. Solder Reflow Profile

# MECHANICAL CASE OUTLINE

## PACKAGE DIMENSIONS

ON Semiconductor®



### 15 PIN FLIPCHIP CSP CASE 499D-01 ISSUE O



SCALE 4:1

DATE 18-OCT-2002

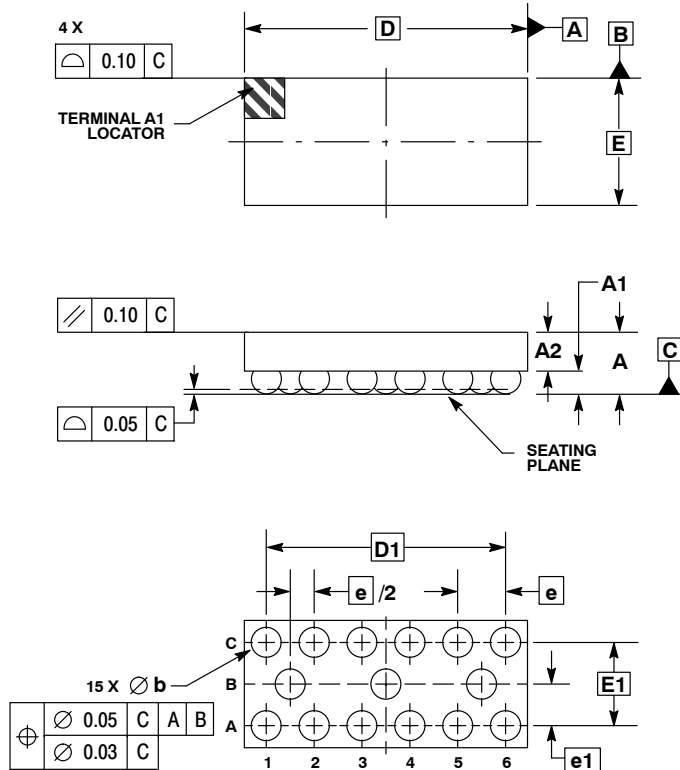

NOTES:

1. DIMENSIONING AND TOLERANCING PER ASME Y14.5M, 1994.
2. CONTROLLING DIMENSION: MILLIMETER.
3. COPLANARITY APPLIES TO SPHERICAL CROWNS OF SOLDER BALLS.

DIM	MILLIMETERS	
	MIN	MAX
A	---	0.700
A1	0.210	0.270
A2	0.380	0.430
D	2.960 BSC	
E	1.330 BSC	
b	0.290	0.340
e	0.500 BSC	
e1	0.435 BSC	
D1	2.500 BSC	
E1	0.870 BSC	

### GENERIC DEVICE MARKING



<b>DOCUMENT NUMBER:</b>	<b>98AON11990D</b>	Electronic versions are uncontrolled except when accessed directly from the Document Repository. Printed versions are uncontrolled except when stamped "CONTROLLED COPY" in red.
<b>DESCRIPTION:</b>	<b>15 PIN FLIPCHIP CSP</b>	<b>PAGE 1 OF 1</b>

ON Semiconductor and are trademarks of Semiconductor Components Industries, LLC dba ON Semiconductor or its subsidiaries in the United States and/or other countries. ON Semiconductor reserves the right to make changes without further notice to any products herein. ON Semiconductor makes no warranty, representation or guarantee regarding the suitability of its products for any particular purpose, nor does ON Semiconductor assume any liability arising out of the application or use of any product or circuit, and specifically disclaims any and all liability, including without limitation special, consequential or incidental damages. ON Semiconductor does not convey any license under its patent rights nor the rights of others.

**onsemi**, **Onsemi**, and other names, marks, and brands are registered and/or common law trademarks of Semiconductor Components Industries, LLC dba "**onsemi**" or its affiliates and/or subsidiaries in the United States and/or other countries. **onsemi** owns the rights to a number of patents, trademarks, copyrights, trade secrets, and other intellectual property. A listing of **onsemi**'s product/patent coverage may be accessed at [www.onsemi.com/site/pdf/Patent-Marking.pdf](http://www.onsemi.com/site/pdf/Patent-Marking.pdf). **onsemi** reserves the right to make changes at any time to any products or information herein, without notice. The information herein is provided "as-is" and **onsemi** makes no warranty, representation or guarantee regarding the accuracy of the information, product features, availability, functionality, or suitability of its products for any particular purpose, nor does **onsemi** assume any liability arising out of the application or use of any product or circuit, and specifically disclaims any and all liability, including without limitation special, consequential or incidental damages. Buyer is responsible for its products and applications using **onsemi** products, including compliance with all laws, regulations and safety requirements or standards, regardless of any support or applications information provided by **onsemi**. "Typical" parameters which may be provided in **onsemi** data sheets and/or specifications can and do vary in different applications and actual performance may vary over time. All operating parameters, including "Typicals" must be validated for each customer application by customer's technical experts. **onsemi** does not convey any license under any of its intellectual property rights nor the rights of others. **onsemi** products are not designed, intended, or authorized for use as a critical component in life support systems or any FDA Class 3 medical devices or medical devices with a same or similar classification in a foreign jurisdiction or any devices intended for implantation in the human body. Should Buyer purchase or use **onsemi** products for any such unintended or unauthorized application, Buyer shall indemnify and hold **onsemi** and its officers, employees, subsidiaries, affiliates, and distributors harmless against all claims, costs, damages, and expenses, and reasonable attorney fees arising out of, directly or indirectly, any claim of personal injury or death associated with such unintended or unauthorized use, even if such claim alleges that **onsemi** was negligent regarding the design or manufacture of the part. **onsemi** is an Equal Opportunity/Affirmative Action Employer. This literature is subject to all applicable copyright laws and is not for resale in any manner.

## PUBLICATION ORDERING INFORMATION

### LITERATURE FULFILLMENT:

Email Requests to: [orderlit@onsemi.com](mailto:orderlit@onsemi.com)

**onsemi Website:** [www.onsemi.com](http://www.onsemi.com)

### TECHNICAL SUPPORT

**North American Technical Support:**  
Voice Mail: 1 800-282-9855 Toll Free USA/Canada  
Phone: 011 421 33 790 2910

**Europe, Middle East and Africa Technical Support:**

Phone: 00421 33 790 2910

For additional information, please contact your local Sales Representative