



Hybrid Couplers 3 dB, 90°



Description

The 1P603AS is a low profile, high performance 3dB hybrid coupler in an easy to use, manufacturing friendly surface mount package. It is designed for W-LAN and MMDS applications. The 1P603AS is designed for balanced amplifiers, variable phase shifters and attenuators, LNAs, signal distribution and is an ideal solution for the ever-increasing demands of the wireless industry for smaller printed circuit boards and high performance. Parts have been subjected to rigorous qualification testing and they are manufactured using materials with coefficients of thermal expansion (CTE) compatible with common substrates such as FR4, G-10, RF-35, RO4003 and polyimide. Produced with 6 of 6 RoHS compliant tin immersion finish.

Features:

- 2330-2700 MHz
- W-LAN and MMDS
- Low Loss
- High Isolation
- 90° Quadrature
- Surface Mountable
- Tape And Reel
- Lead Free
- 100% Tested

ELECTRICAL SPECIFICATIONS**

Frequency	Isolation	Insertion Loss	VSWR
<i>MHz</i>	<i>dB Min</i>	<i>dB Max</i>	<i>Max:1</i>
2300-2700	20	0.30	1.20
Amplitude Balance	Phase Balance	Power	Operating Temp.
<i>dB Max</i>	<i>Degrees</i>	<i>Ave. CW Watts @85°C</i>	<i>°C</i>
± 0.25	± 3	25	-55 to +140

**Specification based on performance of unit properly installed on microstrip printed circuit boards with 50 Ω nominal impedance. Specifications subject to change without notice.

Outline Drawing

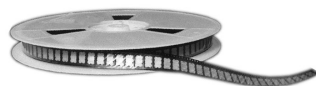
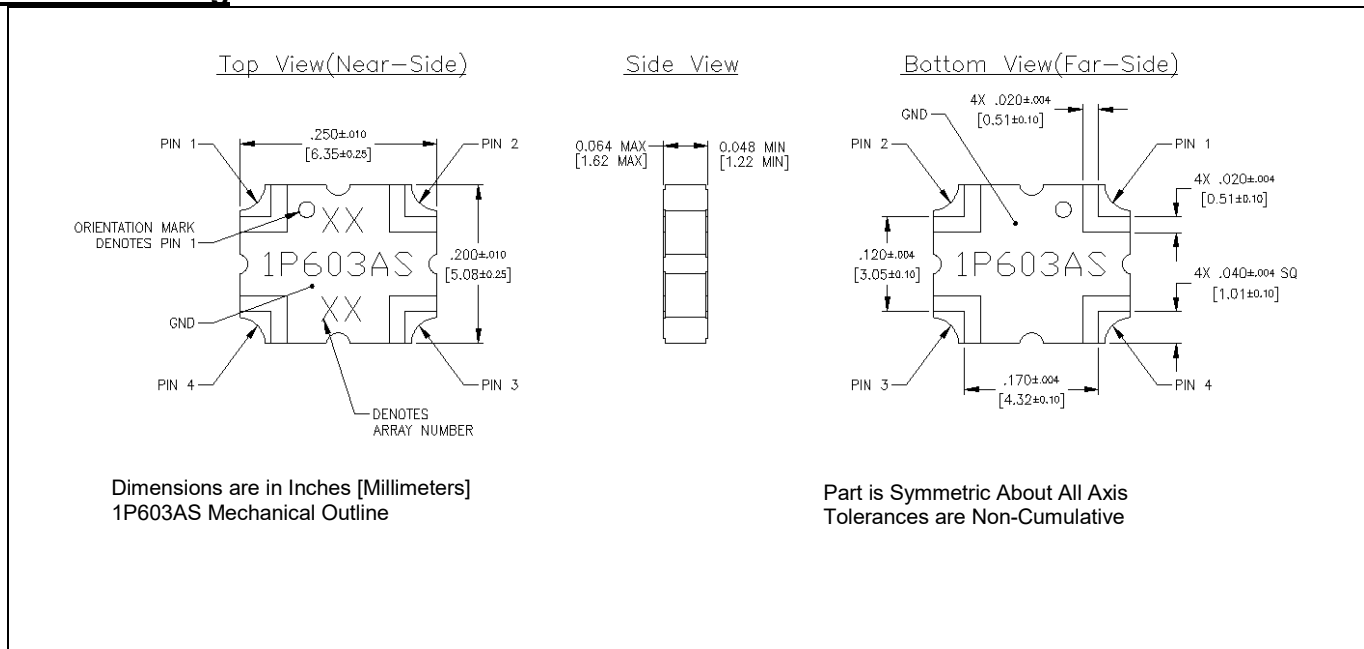

Hybrid Coupler Pin Configuration

The 1P603AS has an orientation marker to denote Pin 1. Once port one has been identified the other ports are known automatically. Please see the chart below for clarification:

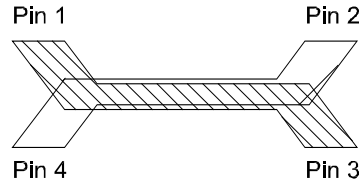

Configuration	Pin 1	Pin 2	Pin 3	Pin 4
Splitter	Input	Isolated	-3dB $\angle\theta - 90$	-3dB $\angle\theta$
Splitter	Isolated	Input	-3dB $\angle\theta$	-3dB $\angle\theta - 90$
Splitter	-3dB $\angle\theta - 90$	-3dB $\angle\theta$	Input	Isolated
Splitter	-3dB $\angle\theta$	-3dB $\angle\theta - 90$	Isolated	Input
*Combiner	$A \angle\theta - 90$	$A \angle\theta$	Isolated	Output
*Combiner	$A \angle\theta$	$A \angle\theta - 90$	Output	Isolated
*Combiner	Isolated	Output	$A \angle\theta - 90$	$A \angle\theta$
*Combiner	Output	Isolated	$A \angle\theta$	$A \angle\theta - 90$

*Notes: “A” is the amplitude of the applied signals. When two quadrature signals with equal amplitudes are applied to the coupler as described in the table, they will combine at the output port. If the amplitudes are not equal, some of the applied energy will be directed to the isolated port.

The actual phase, $\angle\theta$, or amplitude at a given frequency for all ports, can be seen in our de-embedded s-parameters, that can be downloaded at www.anaren.com.

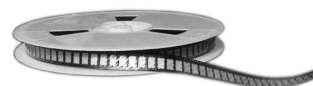

Typical Performance (-55°C, 25°C & 125°C): 2300 - 2700 MHz

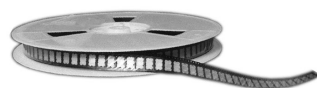
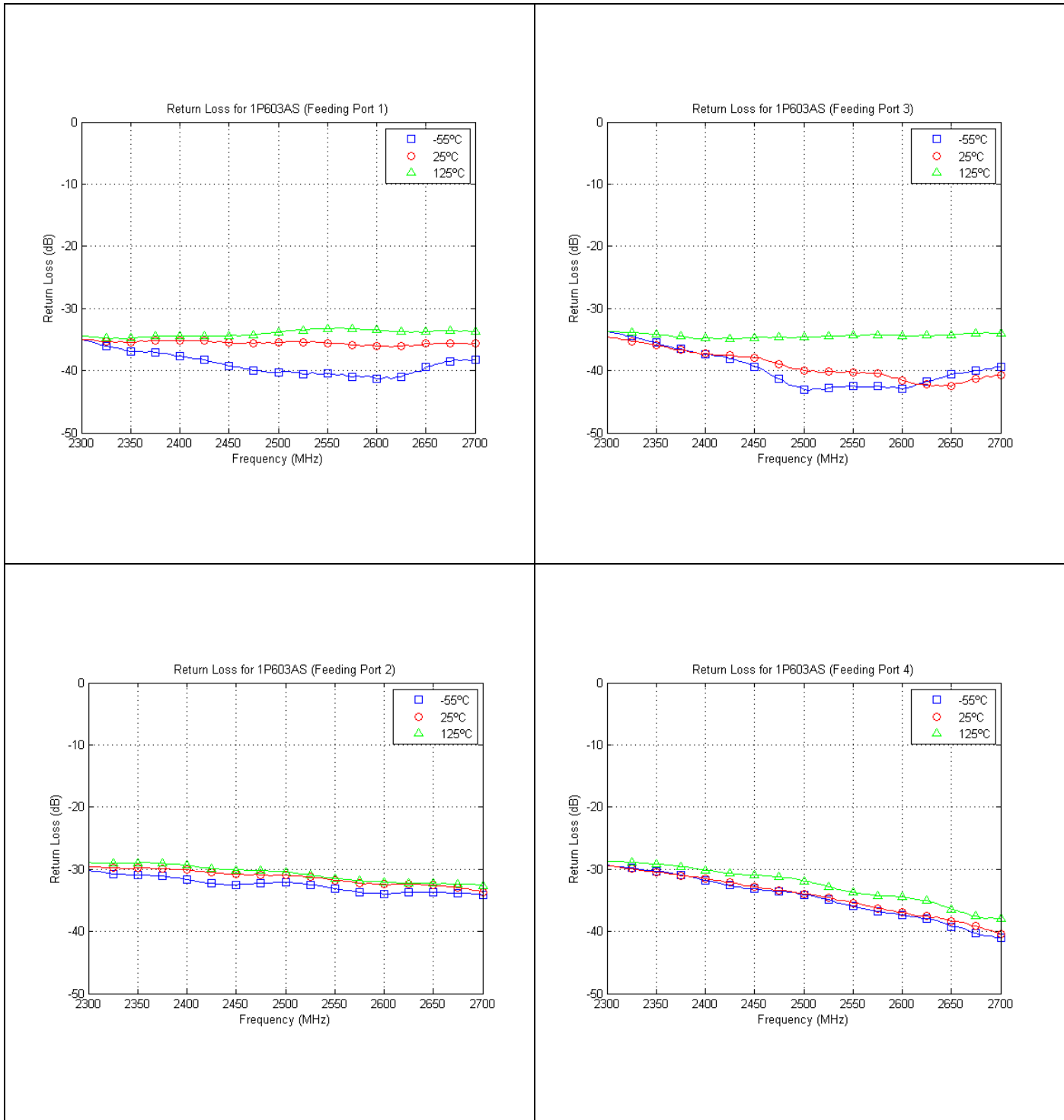

Typical Performance (-55°C, 25°C & 125°C): 2300 - 2700 MHz

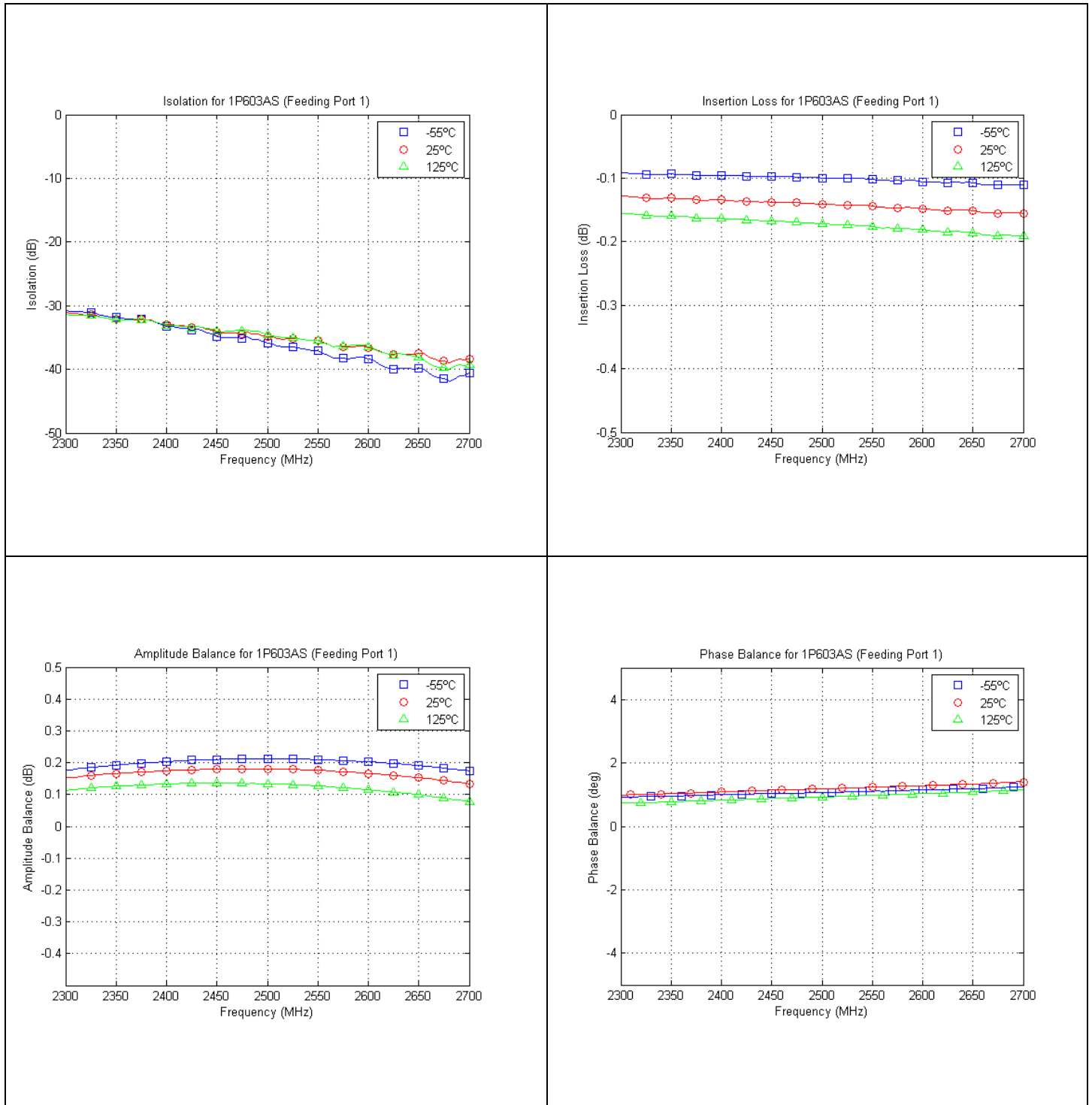

USA/Canada: (315) 233-5510
 Toll Free: (833) 389-6402
 Europe: +44 2392-232392
 Asia: +86 512 62749282

Available on Tape and Reel For Pick and Place Manufacturing.

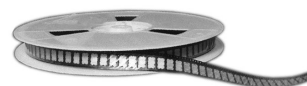

Definition of Measured Specifications

Parameter	Definition	Mathematical Representation
VSWR (Voltage Standing Wave Ratio)	The impedance match of the coupler to a 50Ω system. A VSWR of 1:1 is optimal.	$VSWR = \frac{V_{max}}{V_{min}}$ Vmax = voltage maxima of a standing wave Vmin = voltage minima of a standing wave
Return Loss	The impedance match of the coupler to a 50Ω system. Return Loss is an alternate means to express VSWR.	$\text{Return Loss (dB)} = 20 \log \frac{VSWR + 1}{VSWR - 1}$
Insertion Loss	The input power divided by the sum of the power at the two output ports.	$\text{Insertion Loss (dB)} = 10 \log \frac{P_{in}}{P_{cpl} + P_{direct}}$
Isolation	The input power divided by the power at the isolated port.	$\text{Isolation (dB)} = 10 \log \frac{P_{in}}{P_{iso}}$
Phase Balance	The difference in phase angle between the two output ports.	Phase at coupled port – Phase at direct port
Amplitude Balance	The power at each output divided by the average power of the two outputs.	$10 \log \left(\frac{P_{cpl}}{P_{cpl} + P_{direct}} \right) \text{ and } 10 \log \left(\frac{P_{direct}}{P_{cpl} + P_{direct}} \right)$

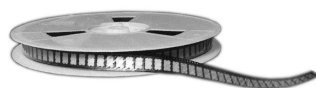

1P603AS Power Derating Curve

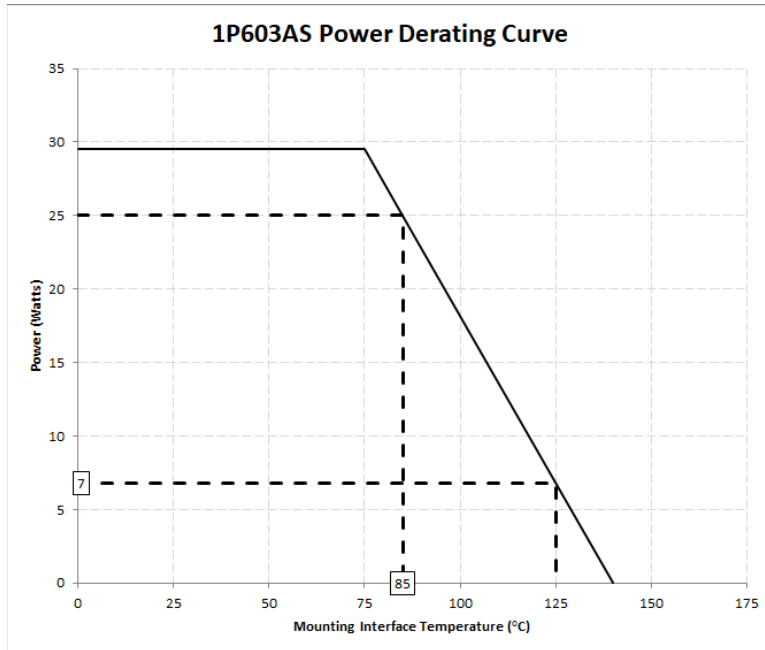

Power Derating:

The power handling and corresponding power derating plots are a function of the thermal resistance, mounting surface temperature (base plate temperature), maximum continuous operating temperature of the coupler, and the thermal insertion loss. The thermal insertion loss is defined in the Power Handling section of the data sheet.

As the mounting interface temperature approaches the maximum continuous operating temperature, the power handling decreases to zero.

USA/Canada: (315) 233-5510
Toll Free: (833) 389-6402
Europe: +44 2392-232392
Asia: +86 512 62749282

Available on Tape and
Reel For Pick and Place
Manufacturing.

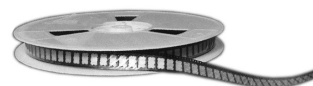

Anaren
What'll we think of nex

Mounting

In order for Xinger surface mount couplers to work optimally, there must be 50Ω transmission lines leading to and from all of the RF ports. Also, there must be a very good ground plane underneath the part to ensure proper electrical performance. If either of these two conditions is not satisfied, electrical performance may not meet published specifications.

Overall ground is improved if a dense population of plated through holes connect the top and bottom ground layers of the PCB. This minimizes ground inductance and improves ground continuity. All of the Xinger hybrid and directional couplers are constructed from ceramic filled PTFE composites which possess excellent electrical and mechanical stability.

When a surface mount hybrid coupler is mounted to a printed circuit board, the primary concerns are; ensuring the RF pads of the device are in contact with the circuit trace of the PCB and insuring the ground plane of neither the component nor the PCB is in contact with the RF signal.

Mounting Footprint

To ensure proper electrical and thermal performance there must be a ground plane with 100% solder connection underneath the part

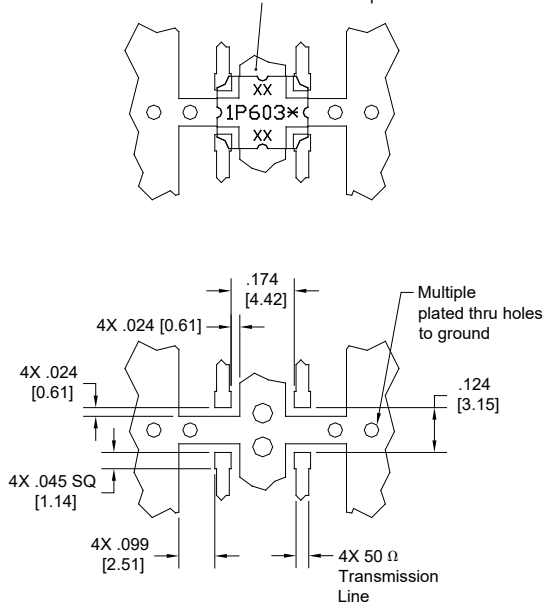

Dimensions are in Inches [Millimeters]

Coupler Mounting Process

The process for assembling this component is a conventional surface mount process as shown in Figure 1. This process is conducive to both low and high volume usage.

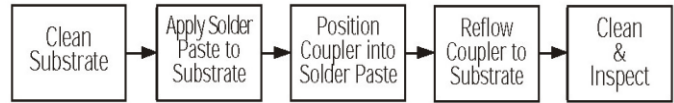
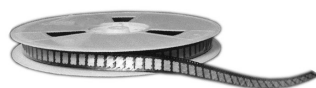

Figure 1: Surface Mounting Process Steps

Storage of Components: Xinger products are available in an immersion tin finish. Commonly used storage procedures used to control oxidation should be followed for these surface mount components. The storage temperatures should be held between 15°C and 60°C.

Substrate: Depending upon the particular component, the circuit material has a coefficient of thermal expansion (CTE) similar to commonly used board substrates such as RF35, RO4003, FR4, polyimide and G-10 materials. The similarity in CTE minimizes solder joint stresses due to similar expansion rates between component and board. Mounting to “hard” substrates (alumina etc.) is possible depending upon operational temperature requirements. The solder surfaces of the coupler are all copper plated with an immersion tin finish.

Solder Paste: All conventional solder paste formulations will work well with Anaren’s Xinger surface mount components. Solder paste can be applied with stencils or syringe dispensers. An example of a stenciled solder paste deposit is shown in Figure 2. As shown in the figure solder paste is applied to the four RF pads and the entire ground plane underneath the body of the part.



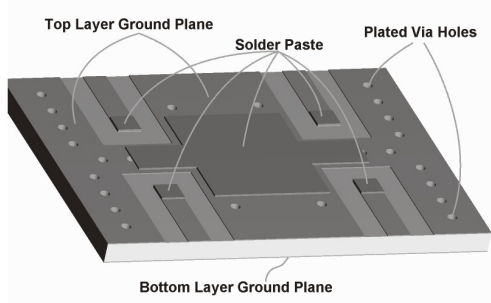

Figure 2: Solder Paste Application

Coupler Positioning: The surface mount coupler can be placed manually or with automatic pick and place mechanisms. Couplers should be placed (see Figure 3 and 4) onto wet paste with common surface mount techniques and parameters. Pick and place systems must supply adequate vacuum to hold a 0.106 gram coupler.

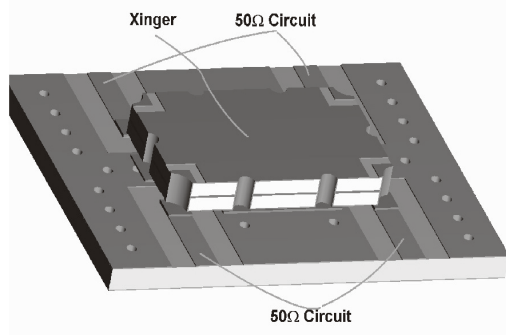

Figure 3: Component Placement

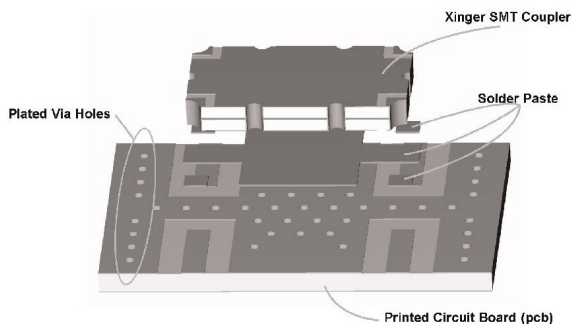
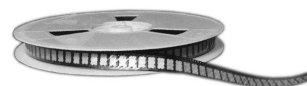

Figure 4: Mounting Features Example

Reflow: The surface mount coupler is conducive to most of today's conventional reflow methods. A low and high temperature thermal reflow profile are shown in Figures 5 and 6, respectively. Manual soldering of these components can be done with conventional surface mount non-contact hot air soldering tools. Board pre-heating is highly recommended for these selective hot air soldering methods. Manual soldering with conventional irons should be avoided.



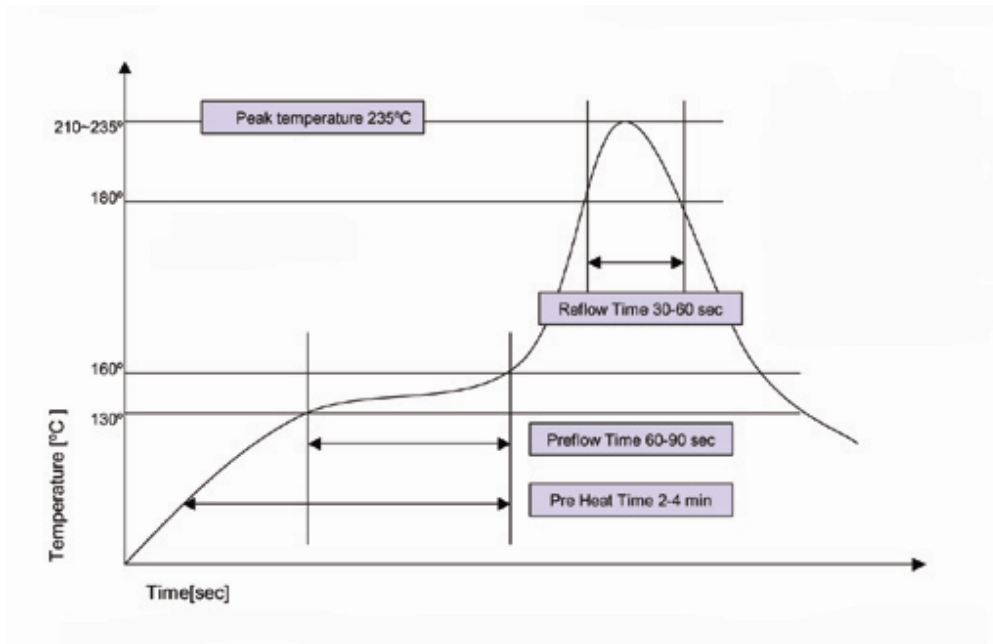

Figure 5 – Low Temperature Solder Reflow Thermal Profile

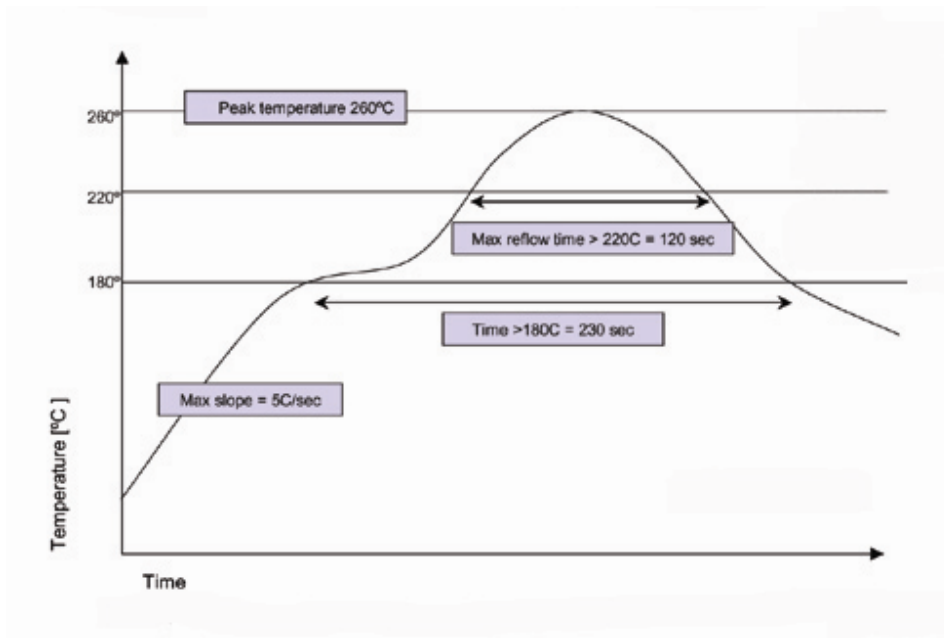
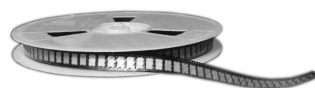
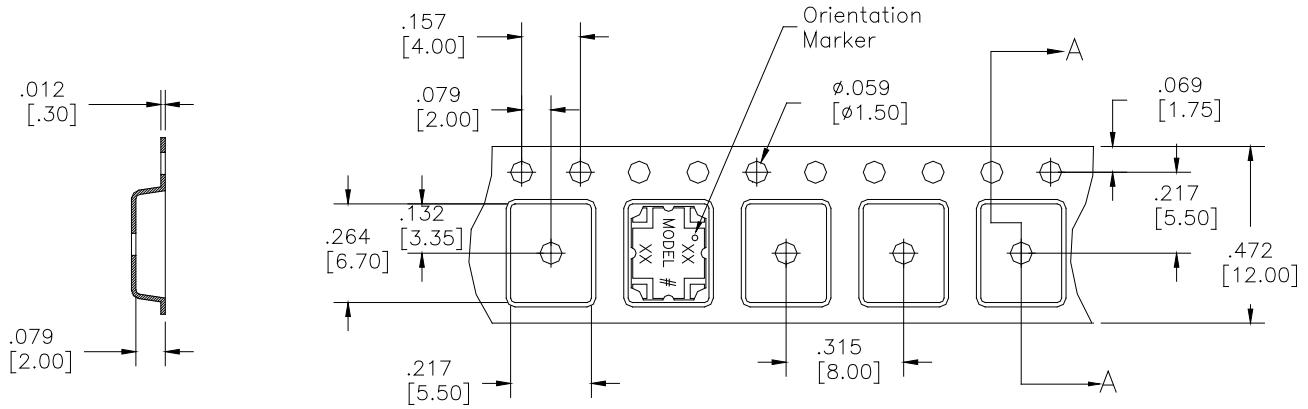

Figure 6 – High Temperature Solder Reflow Thermal Profile



Packaging and Ordering Information

Packaging follows EIA-481-2. Parts are oriented in tape as shown below. Minimum order quantities are 2000 per reel.



SECTION A-A

Dimensions are in inches [mm]

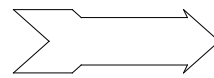

Direction of Part Feed (Unloading)

Xinger® Tape & Reel Diagram

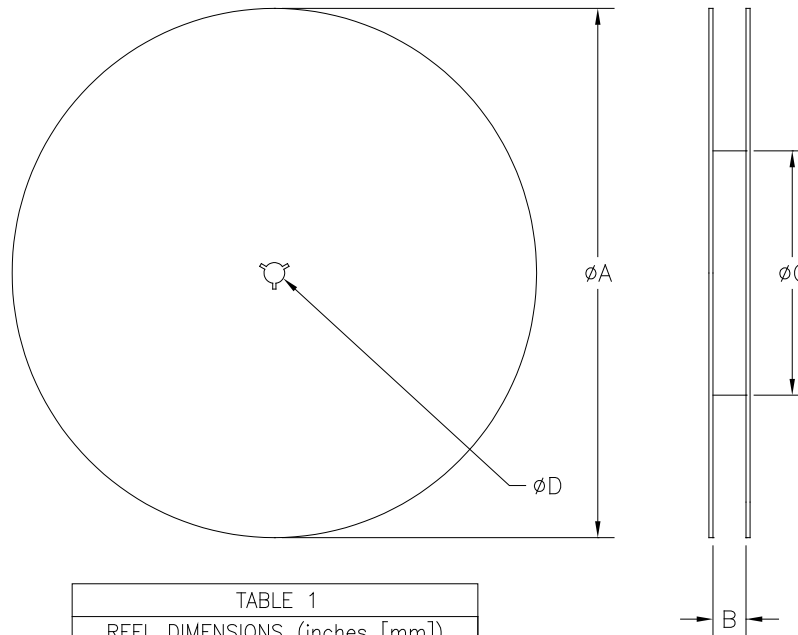

TABLE 1	
REEL DIMENSIONS (inches [mm])	
ϕA	13.3 [333.0]
B	0.472 [12.0]
ϕC	4.017 [102.03]
ϕD	0.512 [13.0]

USA/Canada: (315) 233-5510
 Toll Free: (833) 389-6402
 Europe: +44 2392-232392
 Asia: +86 512 62749282

Available on Tape and Reel For Pick and Place Manufacturing.

