

Low Noise Amplifier with Bypass for LTE

■ GENERAL DESCRIPTION

NJG1173UX2 is low noise amplifier with bypass switch for LTE, which covers frequency from 3300MHz to 3800MHz.

NJG1173UX2 is able to select LNA active mode or bypass mode by low control voltage. This LNA achieves low noise figure and high linearity.

Integrated ESD protection device on each port achieves excellent ESD robustness.

A very small and ultra-thin package EPFFP6-X2 is adopted.

■ PACKAGE OUTLINE

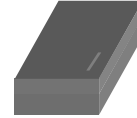

NJG1173UX2

■ APPLICATIONS

LTE receive application

WiMAX 3.5GHz receive application

RF front-end modules, smartphones, data cards and others mobile application

■ FEATURES

- Operating frequencies 3300MHz to 3800MHz
- Low control voltage 1.3V to 5.5V
- Low current consumption 5.0/3.5mA typ. @ $V_{DD}=2.8/1.8V$
- High Gain 13.5dB typ. @ $V_{DD}=2.8V$ $f_{RF}=3500MHz$
- Low Noise figure 1.0dB typ. @ $V_{DD}=2.8V$ $f_{RF}=3500MHz$
- High IIP3 +5.0dBm typ. @ $V_{DD}=2.8V$, $f_{RF}=3500MHz+3510MHz$
- Insertion loss in bypass mode 3.5dB typ. @ $V_{DD}=2.8V$, $f_{RF}=3500MHz$
- Ultra-small package size EPFFP6-X2 (1.1mm x 0.7mm x 0.37mm typ.)
- RoHS compliant and Halogen Free, MSL1

■ PIN CONFIGURATION

(Top view)

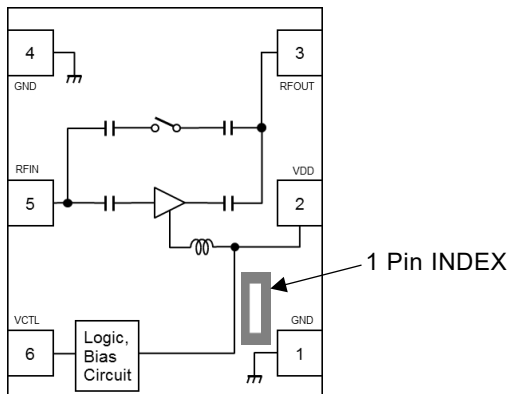

Pin Connection

1. GND
2. VDD
3. RFOUT
4. GND
5. RFIN
6. VCTL

■ TRUTH TABLE

"H"= $V_{CTL}(H)$, "L"= $V_{CTL}(L)$

V_{CTL}	Mode
L	Bypass mode
H	LNA active mode

Note: Specifications and description listed in this datasheet are subject to change without notice

■ ABSOLUTE MAXIMUM RATINGS

General condition: $T_a=+25^{\circ}\text{C}$, $Z_s=Z_l=50\Omega$

PARAMETER	SYMBOL	CONDITIONS	RATINGS	UNITS
Operating voltage	V_{DD}		6.0	V
Control voltage	V_{CTL}		6.0	V
Input power	P_{IN}	$V_{DD}=2.8\text{V}$	+15	dBm
Power dissipation	P_D	4-layer FR4 PCB with through-hole (101.5x114.5mm), $T_j=150^{\circ}\text{C}$	430	mW
Operating temperature	T_{opr}		-40 to +105	$^{\circ}\text{C}$
Storage temperature	T_{stg}		-55 to +150	$^{\circ}\text{C}$

■ ELECTRICAL CHARACTERISTICS 1 (DC)

General condition: $T_a=+25^{\circ}\text{C}$

PARAMETERS	SYMBOL	CONDITIONS	MIN	TYP	MAX	UNITS
Operating voltage	V_{DD}		1.5	-	5.5	V
Control voltage (High)	$V_{CTL(H)}$		1.3	1.8	5.5	V
Control voltage (Low)	$V_{CTL(L)}$		0	0	0.3	V
Operating current 1	I_{DD1}	RF OFF, $V_{DD}=2.8\text{V}$, $V_{CTL}=1.8\text{V}$	-	5.0	8.0	mA
Operating current 2	I_{DD2}	RF OFF, $V_{DD}=1.8\text{V}$, $V_{CTL}=1.8\text{V}$	-	3.5	7.0	mA
Operating current 3	I_{DD3}	RF OFF, $V_{DD}=2.8\text{V}$, $V_{CTL}=0\text{V}$	-	15	60	μA
Operating current 4	I_{DD4}	RF OFF, $V_{DD}=1.8\text{V}$, $V_{CTL}=0\text{V}$	-	10	60	μA
Control current	I_{CTL}	RF OFF, $V_{CTL}=1.8\text{V}$	-	7	20	μA

■ ELECTRICAL CHARACTERISTICS 2 (LNA active mode)

General Condition: $V_{DD}=2.8V$, $V_{CTL}=1.8V$, $f_{RF}=3500MHz$, $T_a=+25^{\circ}C$, $Z_s=Z_l=50\Omega$, with application circuit

PARAMETERS	SYMBOL	CONDITIONS	MIN	TYP	MAX	UNITS
Small signal gain1	Gain1	Exclude PCB & connector losses(0.32dB)	11.0	13.5	16.0	dB
Noise figure1	NF1	Exclude PCB & connector losses(0.14dB)	-	1.0	1.6	dB
Input power at 1dB gain compression point1(1)	P-1dB(IN)1(1)		-13.0	-10.0	-	dBm
Input 3rd order intercept point1(1)	IIP3_1(1)	$f1=f_{RF}$, $f2=f_{RF}+10MHz$, $P_{IN}=-28dBm$	-2.0	+5.0	-	dBm
Gain settling time1(1)	Ts1(1)	Bypass to LNA active mode To be within 1 dB of the final gain	-	1.0	2.5	μs
Gain settling time1(2)	Ts1(2)	LNA active to Bypass mode To be within 1 dB of the final insertion loss	-	0.8	2.5	μs
RF IN Return loss1(1)	RLi1(1)		5.0	9.0	-	dB
RF OUT Return loss1(1)	RLo1(1)		10.0	15.0	-	dB

■ ELECTRICAL CHARACTERISTICS 3 (Bypass mode)

General Condition: $V_{DD}=2.8V$, $V_{CTL}=0V$, $f_{RF}=3500MHz$, $T_a=+25^{\circ}C$, $Z_s=Z_l=50\Omega$, with application circuit

PARAMETERS	SYMBOL	CONDITIONS	MIN	TYP	MAX	UNITS
Insertion Loss1	Loss1	Exclude PCB & connector losses(0.32dB)	-	3.5	5.0	dB
Input power at 1dB Compression point1(2)	P-1dB(IN)1(2)		-1.0	+10.0	-	dBm
Input 3rd order intercept point1(2)	IIP3_1(2)	$f1=f_{RF}$, $f2=f_{RF}+10MHz$, $P_{IN}=-10dBm$	+9.0	+18.0	-	dBm
RF IN Return loss1(2)	RLi1(2)		5.0	7.0	-	dB
RF OUT Return loss1(2)	RLo1(2)		4.0	6.0	-	dB

■ ELECTRICAL CHARACTERISTICS 4 (LNA active mode)

General Condition: $V_{DD}=1.8V$, $V_{CTL}=1.8V$, $f_{RF}=3500MHz$, $T_a=+25^{\circ}C$, $Z_s=Z_l=50\Omega$, with application circuit

PARAMETERS	SYMBOL	CONDITIONS	MIN	TYP	MAX	UNITS
Small signal gain ₂	Gain ₂	Exclude PCB & connector losses(0.32dB)	-	12.0	-	dB
Noise figure ₂	NF ₂	Exclude PCB & connector losses(0.14dB)	-	1.3	-	dB
Input power at 1dB gain compression point ₂ (1)	P-1dB(IN) ₂ (1)		-	-12.0	-	dBm
Input 3rd order intercept point ₂ (1)	IIP3_2(1)	$f_1=f_{RF}$, $f_2=f_{RF}+10MHz$, $P_{IN}=-28dBm$	-	0	-	dBm
Gain settling Time ₂ (1)	Ts ₂ (1)	Bypass to LNA active mode To be within 1 dB of the final gain	-	2.0	-	μs
Gain settling Time ₂ (2)	Ts ₂ (2)	LNA active to Bypass mode To be within 1 dB of the final insertion loss	-	0.8	-	μs
RF IN Return loss ₂ (1)	RLi ₂ (1)		-	8.0	-	dB
RF OUT Return loss ₂ (1)	RLo ₂ (1)		-	15.0	-	dB

■ ELECTRICAL CHARACTERISTICS 5 (Bypass mode)

General Condition: $V_{DD}=1.8V$, $V_{CTL}=0V$, $f_{RF}=3500MHz$, $T_a=+25^{\circ}C$, $Z_s=Z_l=50\Omega$, with application circuit

PARAMETERS	SYMBOL	CONDITIONS	MIN	TYP	MAX	UNITS
Insertion Loss ₂	Loss ₂	Exclude PCB & connector losses(0.32dB)	-	3.5	-	dB
Input power at 1dB compression Point ₂ (2)	P-1dB(IN) ₂ (2)		-	+9.0	-	dBm
Input 3rd order intercept point ₂ (2)	IIP3_2(2)	$f_1=f_{RF}$, $f_2=f_{RF}+10MHz$, $P_{IN}=-10dBm$	-	+17.0	-	dBm
RF IN Return loss ₂ (2)	RLi ₂ (2)		-	7.0	-	dB
RF OUT Return loss ₂ (2)	RLo ₂ (2)		-	6.0	-	dB

■ TERMINAL INFORMATION

No.	SYMBOL	DESCRIPTION
1	GND	Ground terminal. This terminal should be connected to the ground plane as close as possible for excellent RF performance.
2	VDD	Supply voltage terminal. Please connect bypass capacitor C1 with ground as close as possible.
3	RFOUT	RF output terminal. This terminal requires no DC blocking capacitor since this IC has internal output matching circuit including DC blocking capacitor.
4	GND	Ground terminal. This terminal should be connected to the ground plane as close as possible for excellent RF performance.
5	RFIN	RF input terminal. This terminal requires only a matching inductor L1, and does not require DC blocking capacitor.
6	VCTL	Control voltage terminal.

■ ELECTRICAL CHARACTERISTICS (LNA active mode)

Conditions: $V_{DD}=2.8V$, $V_{CTL}=1.8V$, $f_{RF}=3500MHz$, $T_a=+25^\circ C$, $Z_s=Z_l=50\Omega$, with application circuit

Gain, NF vs. frequency

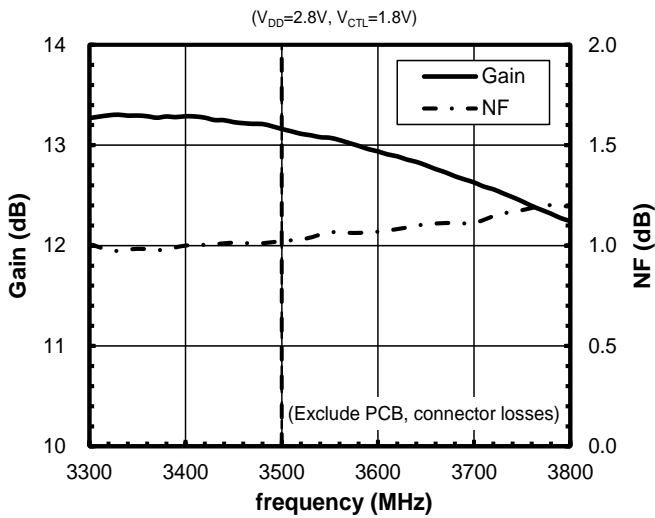

Gain, I_{DD} vs. Pin

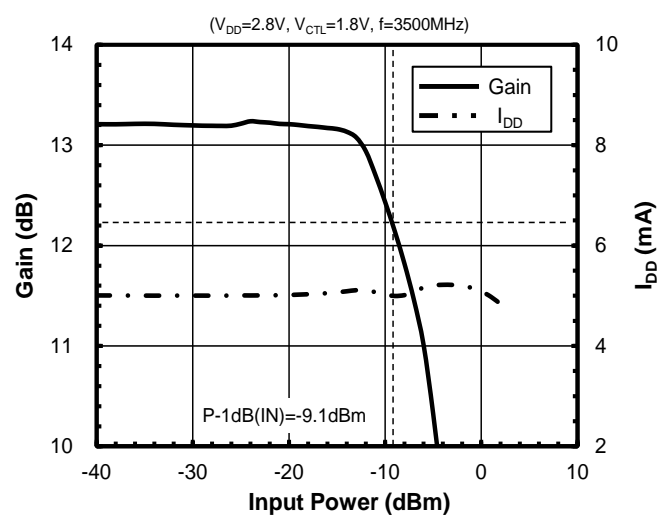

Pout vs. Pin

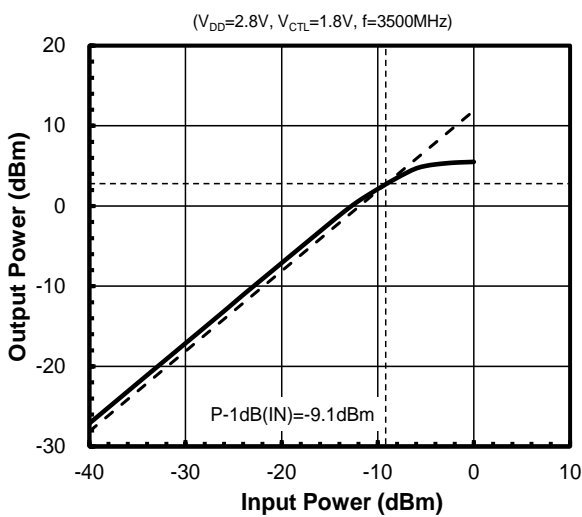

P-1dB(IN) vs. frequency

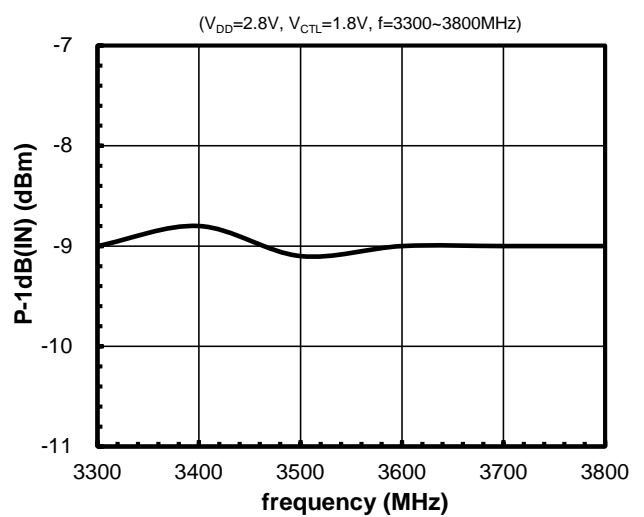

IIP3, OIP3 vs. frequency

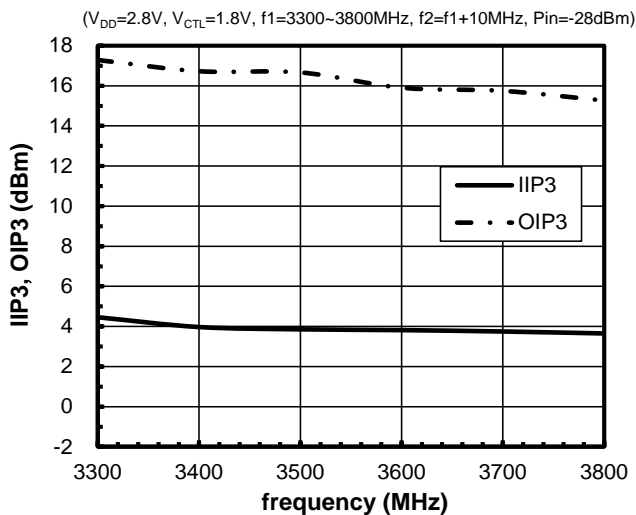

Pout, IM3 vs. Pin

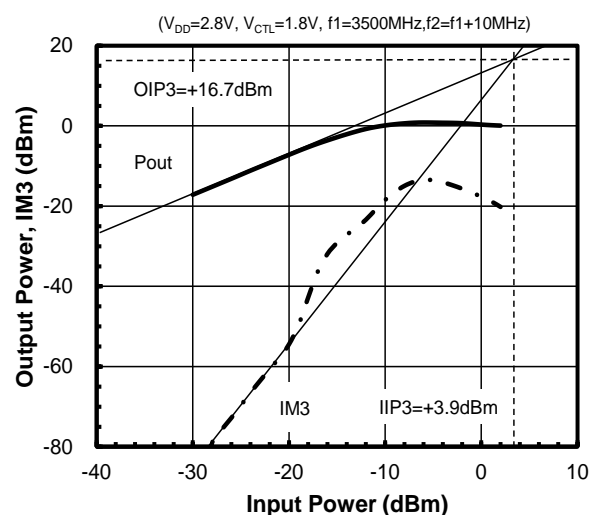

■ ELECTRICAL CHARACTERISTICS (LNA active mode)

Conditions: $V_{DD}=2.8V$, $V_{CTL}=1.8V$, $f_{RF}=50MHz$ to $6000MHz$, $T_a=+25^\circ C$, $Z_s=Z_l=50\Omega$, with application circuit

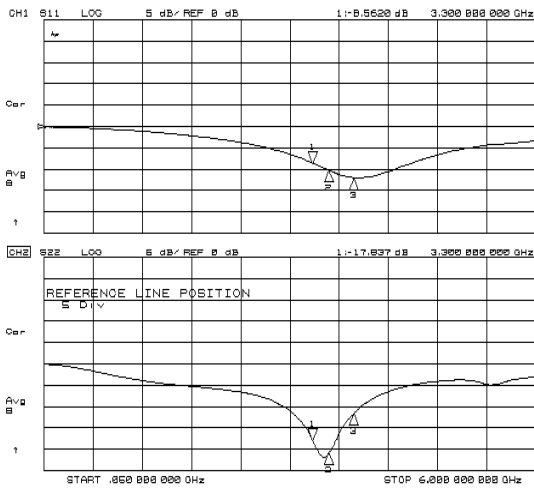

S11, S22

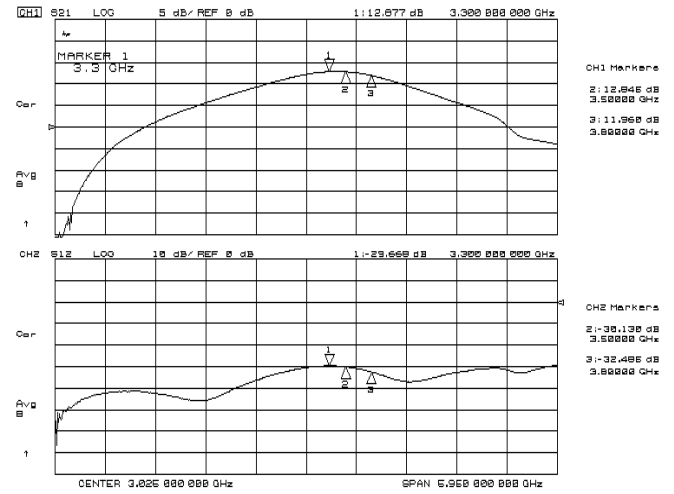

S21, S12

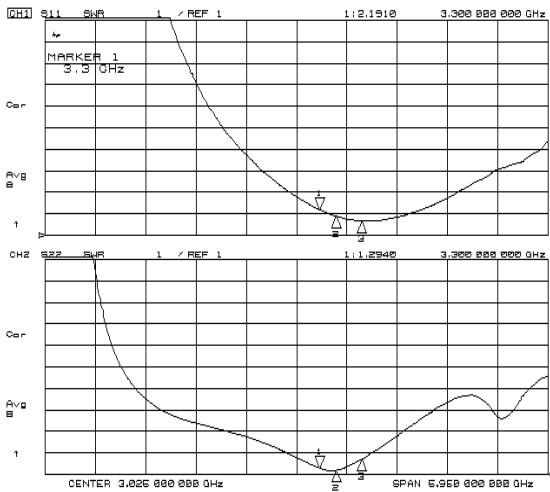

VSWRi, VSWRo

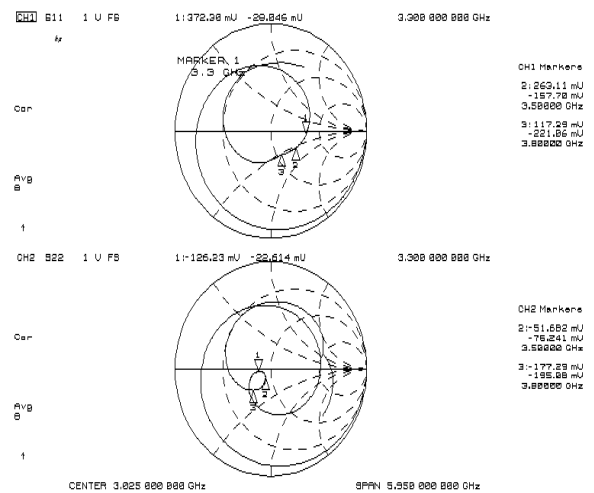

Zin, Zout

■ ELECTRICAL CHARACTERISTICS (Bypass mode)

Conditions: $V_{DD}=2.8V$, $V_{CTL}=0V$, $f_{RF}=3500MHz$, $T_a=+25^{\circ}C$, $Z_s=Z_l=50\Omega$, with application circuit

Loss vs. frequency

($V_{DD}=2.8V$, $V_{CTL}=0V$)

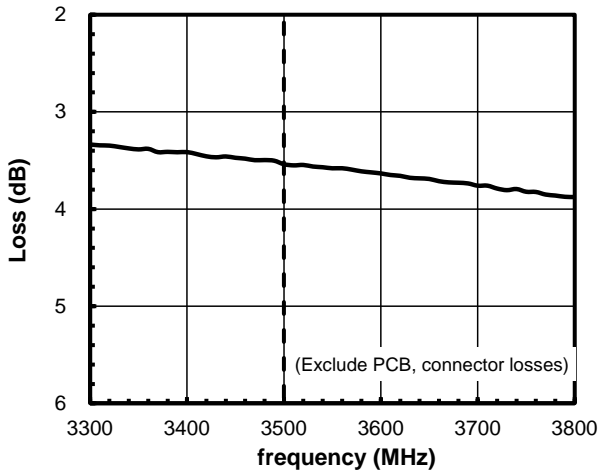

Loss, I_{DD} vs. Pin

($V_{DD}=2.8V$, $V_{CTL}=0V$, $f=3500MHz$)

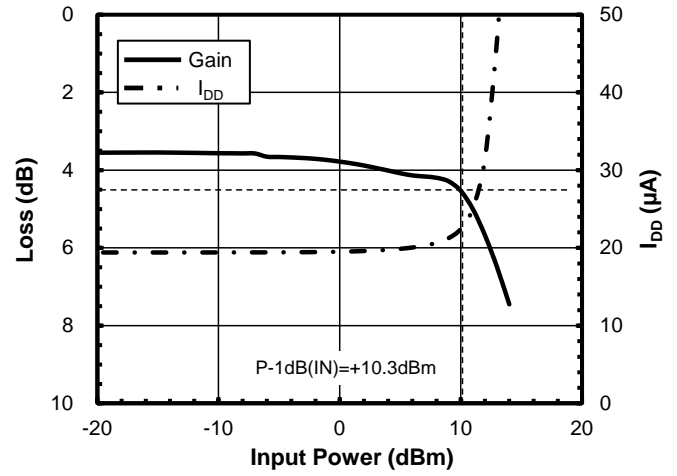

Pout vs. Pin

($V_{DD}=2.8V$, $V_{CTL}=0V$, $f=3500MHz$)

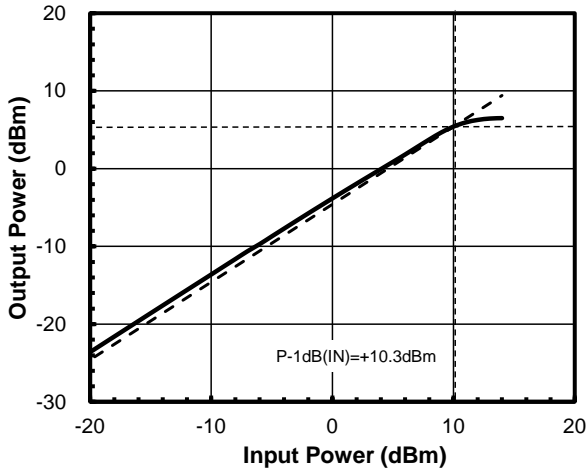

P-1dB(IN) vs. frequency

($V_{DD}=2.8V$, $V_{CTL}=0V$, $f=3300-3800MHz$)

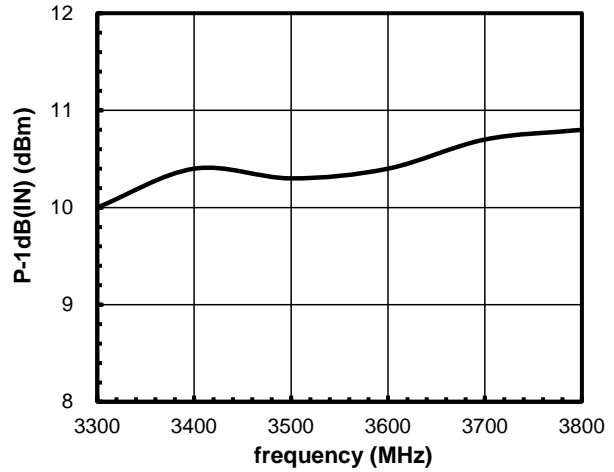

IIP3, OIP3 vs. frequency

($V_{DD}=2.8V$, $V_{CTL}=0V$, $f_1=3300-3800MHz$, $f_2=f_1+10MHz$, $Pin=-10dBm$)

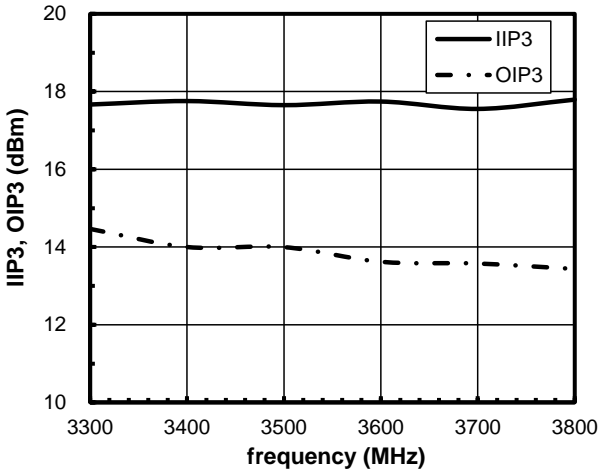

Pout, IM3 vs. Pin

($V_{DD}=2.8V$, $V_{CTL}=0V$, $f_1=3500MHz$, $f_2=f_1+10MHz$)

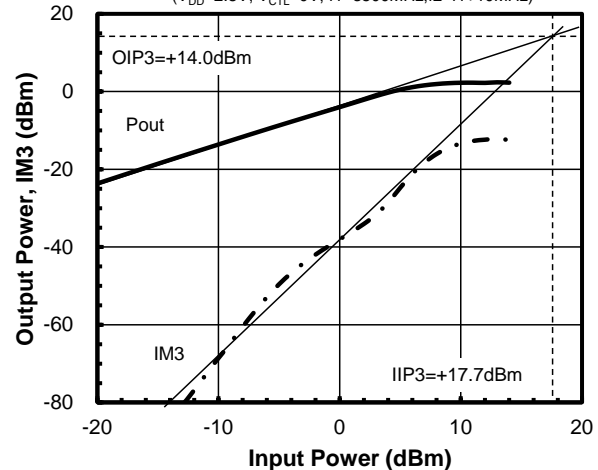

■ ELECTRICAL CHARACTERISTICS (Bypass mode)

Conditions: $V_{DD}=2.8V$, $V_{CTL}=0V$, $f_{RF}=50MHz$ to $6000MHz$, $T_a=+25^\circ C$, $Z_s=Z_l=50\Omega$, with application circuit

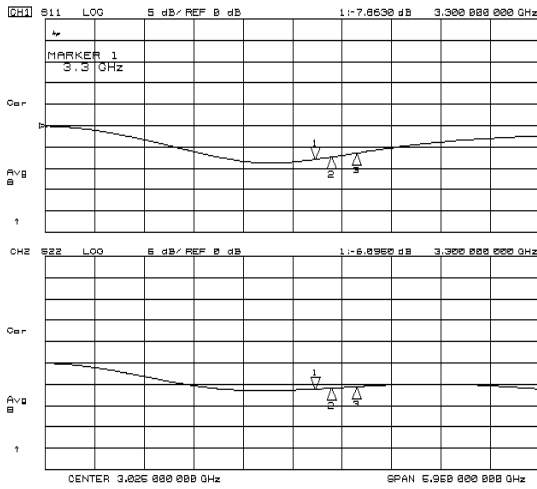

S11, S22

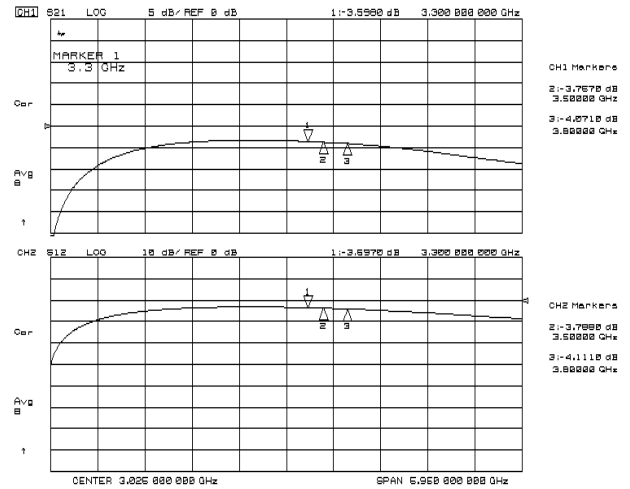

S21, S12

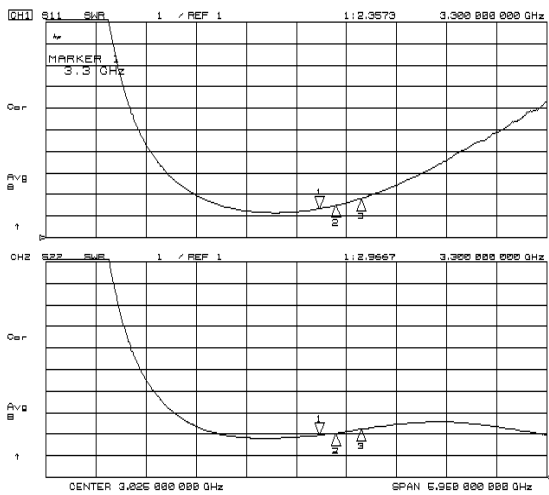

VSWRi, VSWRo

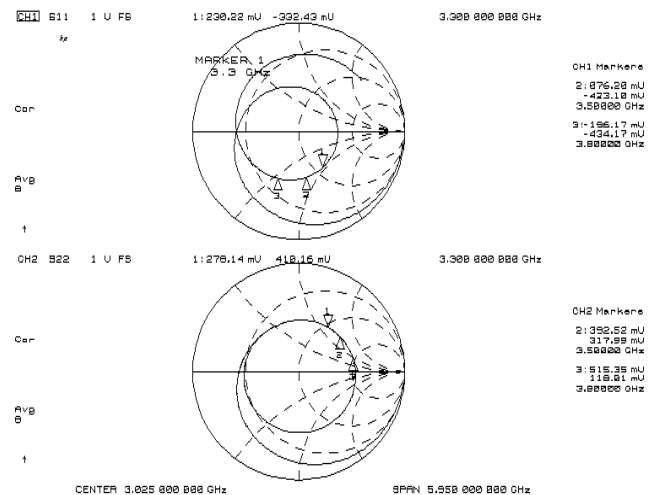

Zin, Zout

APPLICATION CIRCUIT

(TOP VIEW)

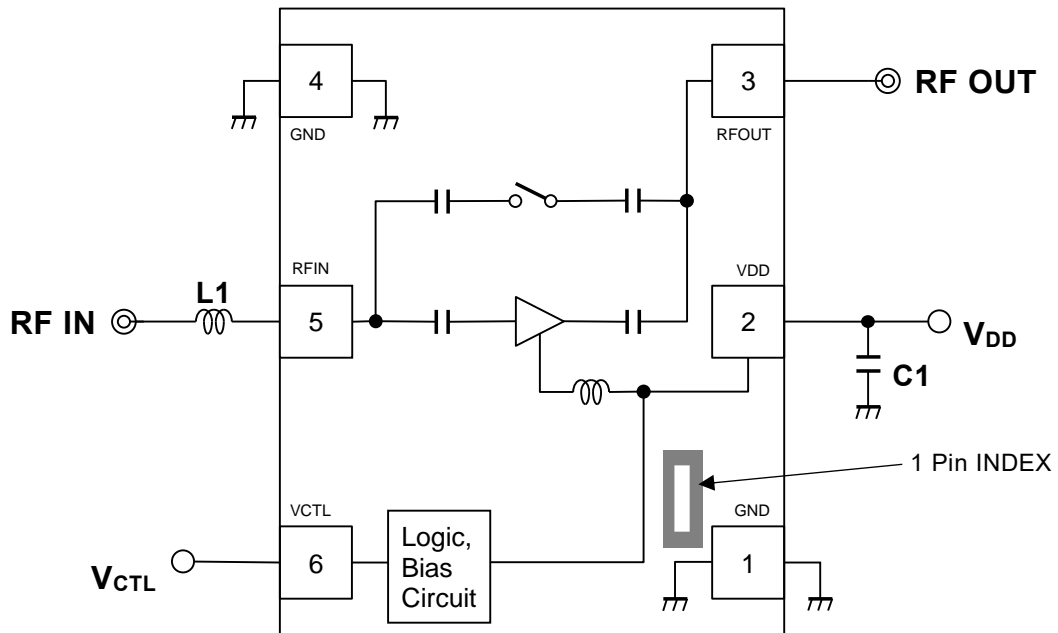

Parts list

Parts ID	Value	Manufacture
L1	2.9nH	LQW15AN_00 Series (MURATA)
C1	1000pF	GRM03 Series (MURATA)

■ MEASUREMENT BLOCK DIAGRAM

Measuring instruments

NF Analyzer : Keysight N8975A
 Noise Source : Keysight 346A

Setting the NF analyzer

Measurement mode form

Device under test : Amplifier
 System downconverter : off

Mode setup form

Sideband : LSB
 Averages : 16
 Average mode : Point
 Bandwidth : 4MHz
 Loss comp : off
 Tcold : setting the temperature of noise source (305.15K)

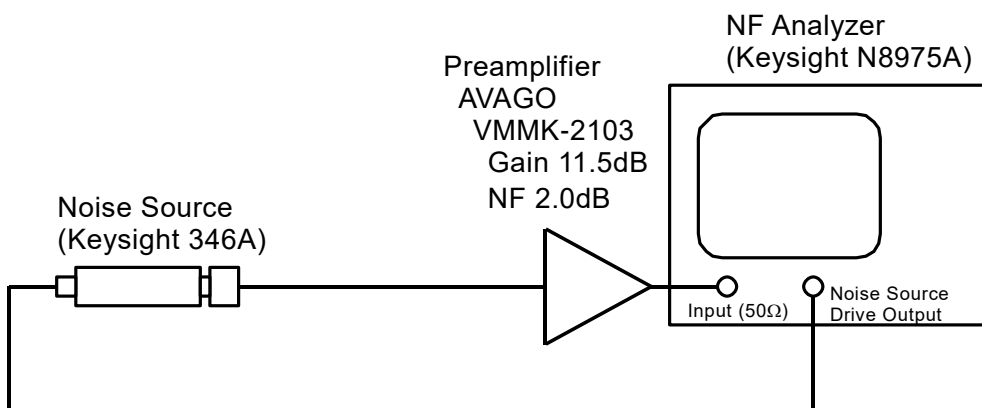

* Preamplifier is used to improve NF measurement accuracy.
 * Noise source, preamplifier and NF analyzer are connected directly.

Calibration setup

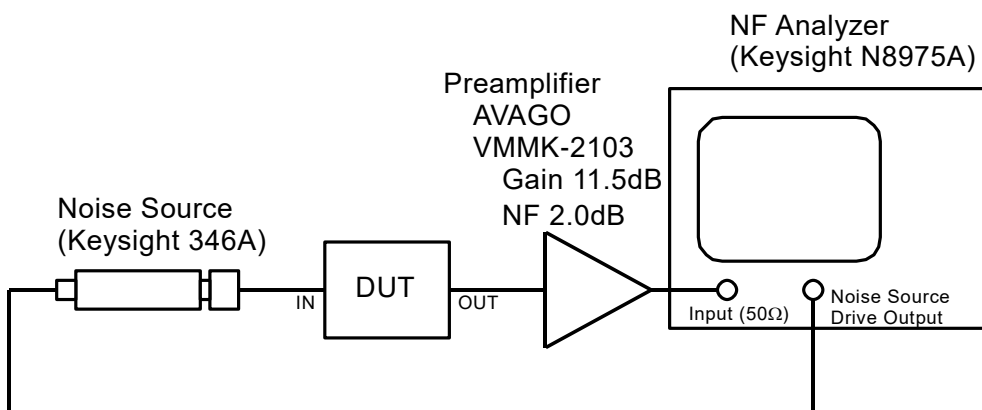

* Noise source, DUT, preamplifier and NF analyzer are connected directly.

Measurement Setup

■ EVALUATION BOARD

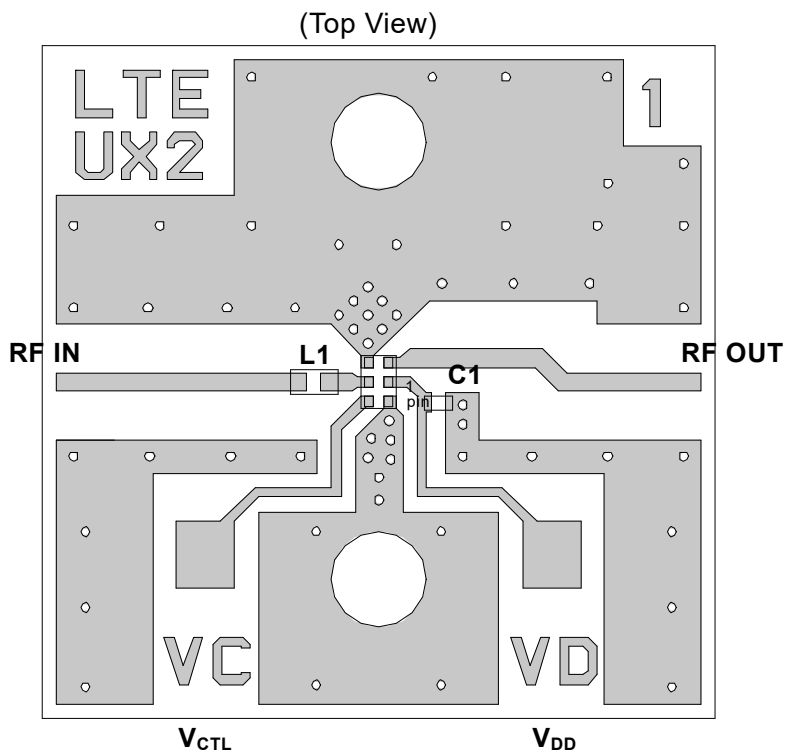

PCB Information

Substrate: FR-4

Thickness: 0.2mm

Microstrip line width: 0.4mm ($Z_0=50\Omega$)

Size: 14.0mm x 14.0mm

< PCB LAYOUT GUIDELINE >

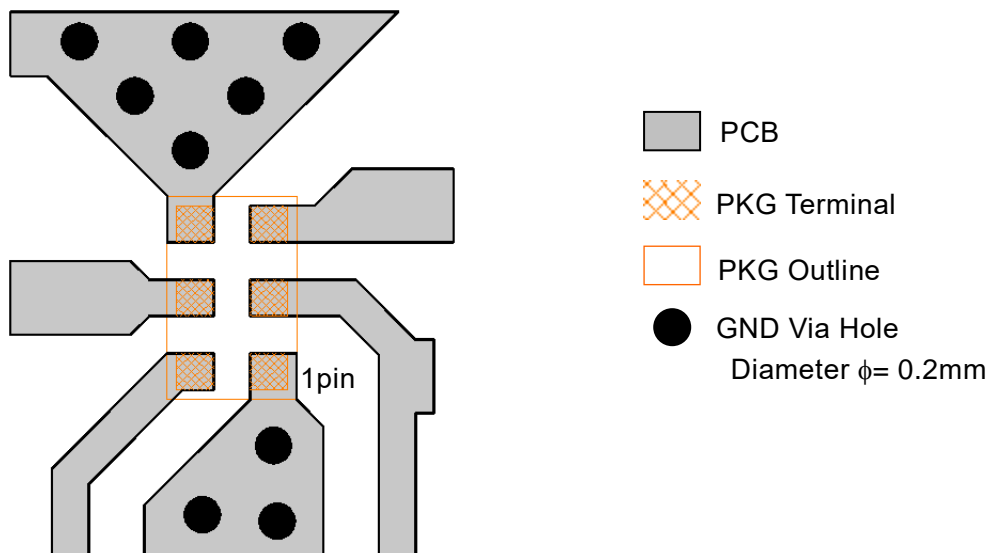

PRECAUTIONS

- All external parts should be placed as close as possible to the IC.
- For good RF performance, all GND terminals must be connected to PCB ground plane of substrate, and via-holes for GND should be placed near the IC.

RECOMMENDED FOOTPRINT PATTERN (EPFFP6-X2 PACKAGE)

Package: 1.1mm x 0.7mm

Pin pitch: 0.4mm

 : Land

 : Mask (Open area) *Metal mask thickness: 100μm

 : Resist (Open area)

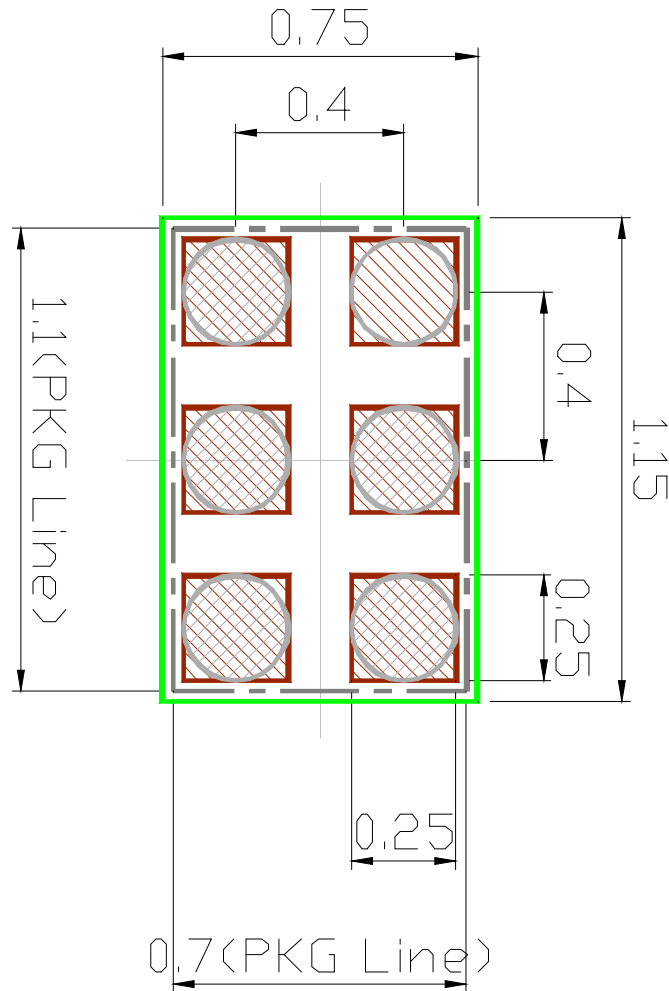

Unit : mm

■ PACKAGE OUTLINE (EPFFP6-X2)

TOP VIEW

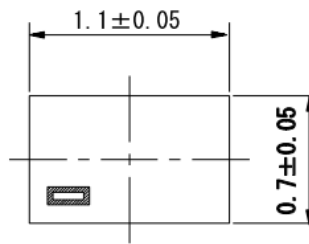

SIDE VIEW

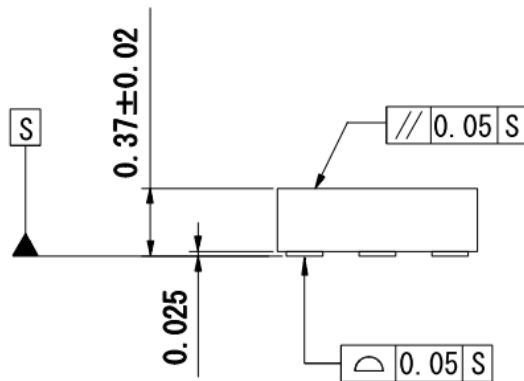

BOTTOM VIEW

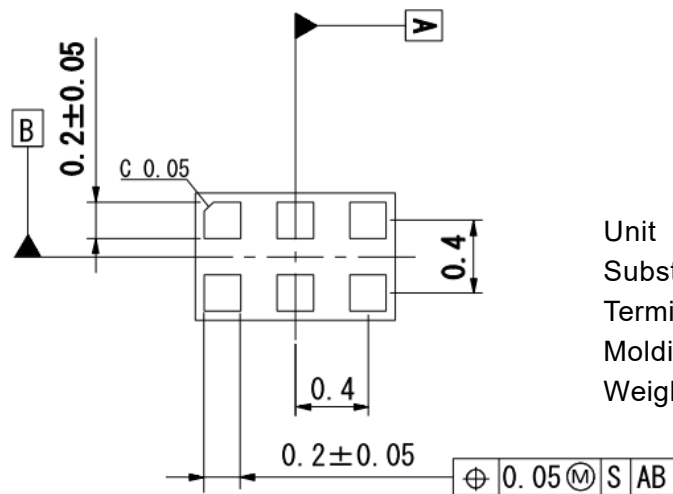

Unit	: mm
Substrate	: FR4
Terminal treat	: Ni/Pd/Au
Molding material	: Epoxy resin
Weight (typ.)	: 0.7mg

Cautions on using this product

This product contains Gallium-Arsenide (GaAs) which is a harmful material.

- Do NOT eat or put into mouth.
- Do NOT dispose in fire or break up this product.
- Do NOT chemically make gas or powder with this product.
- To waste this product, please obey the relating law of your country.

This product may be damaged with electric static discharge (ESD) or spike voltage. Please handle with care to avoid these damages.

[CAUTION]

The specifications on this databook are only given for information, without any guarantee as regards either mistakes or omissions.

The application circuits in this databook are described only to show representative usages of the product and not intended for the guarantee or permission of any right including the industrial rights.