

MBR20200CT/MBRF20200CT

Schottky Barrier Rectifier
 Reverse Voltage 200 V Forward Current 20 A

Features

- Plastic package has underwriters Laboratory Flammability Classification 94V-0
- Dual rectifier construction, positive center tap
- Low forward voltage, high efficiency
- Guarding for over voltage protection



MBR20200CT
 Package: TO-220-AB

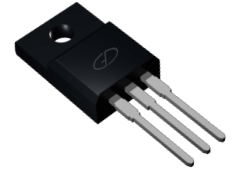

MBRF20200CT
 Package: ITO-220-AB

Mechanical Data

- Case: epoxy, molded
- Weight: 1.9grams (approximately)
- Finish: all external surfaces corrosion resistant and terminal leads readily solderable
- Lead temperature for soldering purpose: 260°C max. for 10 sec
- 50 units per plastic tube

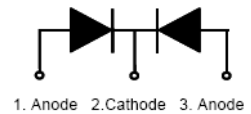

Schematic Diagram

Maximum Ratings & Electrical Characteristics

(T_A=25°C unless otherwise noted)

Parameter	Test Conditions		Symbol	Value	Unit
Maximum Repetitive Peak Reverse Voltage			V _{RRM}	200	V
Working Peak Reverse Voltage			V _{RWM}	200	V
Maximum DC Blocking Voltage			V _{DC}	200	V
Maximum Average Forward Rectified Current @ T _c =105°C	Total Device		I _{F(AV)}	20	A
	Per Diode			10	
Peak Forward Surge Current 8.3ms Single Half Sine-wave Superimposed on Rated Load per Diode			I _{FSM}	150	A
Peak repetitive Reverse Current Per Leg at tp=2.0μs ,1KHz			I _{RRM}	1.0	A
Voltage Rate of Change (rated V _R)			DV/dt	10000	V/μs
Operating Junction Temperature Range			T _J	- 55 to+150	°C
Storage Temperature Range			T _{STG}	- 55 to+150	°C
Isolation Voltage (ITO-220-AB only) from Terminal to Heatsink t = 1 sec			V _{AC}	1500	V
Maximum Instantaneous Forward Voltage per Leg	I _F =10A I _F =10A	T _c =25°C T _c =125°C	V _F	0.95 0.85	V
Maximum Reverse Current per Leg at Working Peak Reverse Voltage		T _J =25°C T _J =100°C		I _R	
Thermal Characteristics (T_A=25°C unless otherwise noted)					
Symbol	Parameter	Typ.(TO-220-AB)		Typ.(ITO-220-AB)	Unit
R _{θJC}	Thermal Resistance, Junction to Case per Leg	2.0		4.0	°C/W
R _{θJA}	Thermal Resistance, Junction to Ambient per Leg	62.5		62.5	°C/W

Note: Pulse test:300us pulse width, duty cycle=2%

Ratings and Characteristics Curves ($T_A = 25^\circ\text{C}$ unless otherwise noted)

FIG.1- FORWARD CURRENT DERATING CURVE

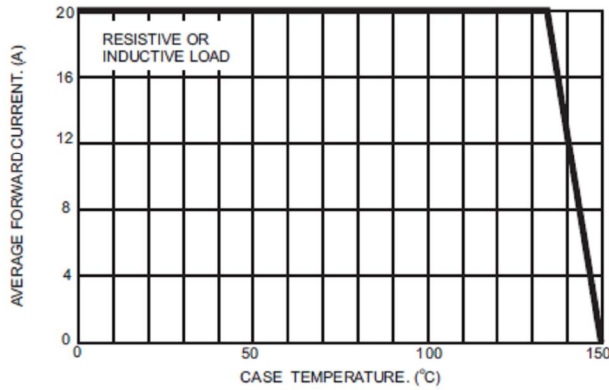

FIG.2- MAXIMUM NON-REPETITIVE FORWARD SURGE CURRENT PER LEG

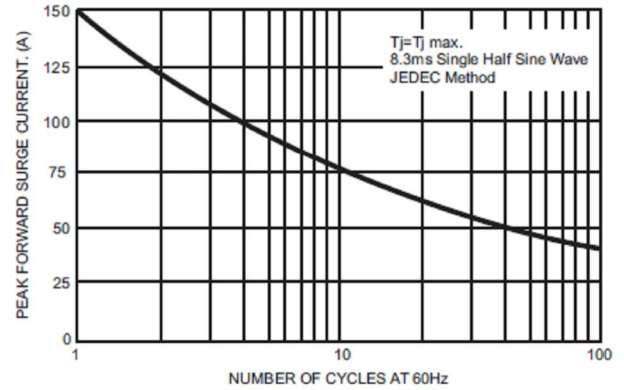

FIG.3- TYPICAL INSTANTANEOUS FORWARD CHARACTERISTICS PER LEG

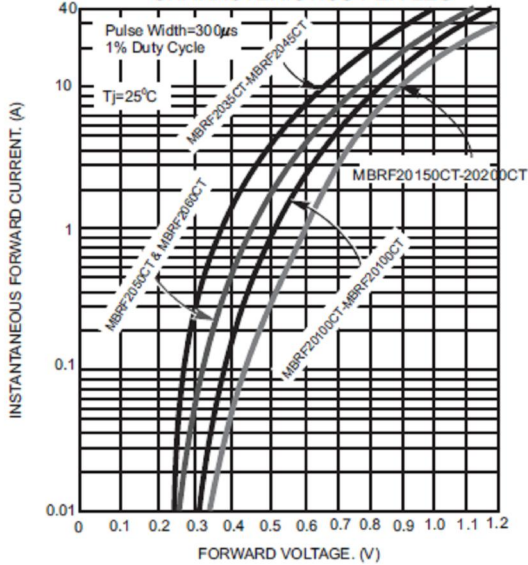

FIG.4- TYPICAL REVERSE CHARACTERISTICS PER LEG

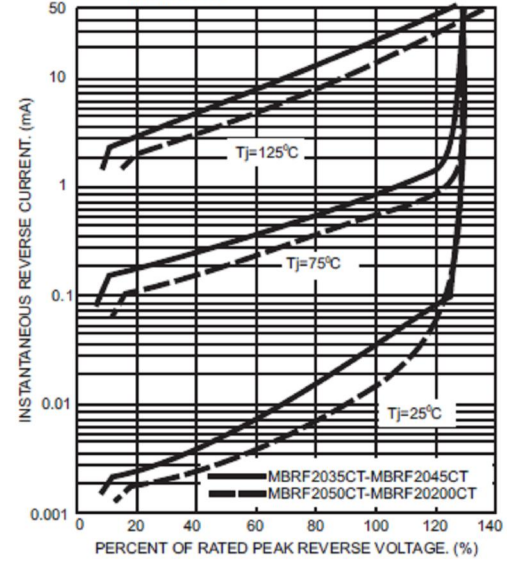

FIG.5- TYPICAL JUNCTION CAPACITANCE PER LEG

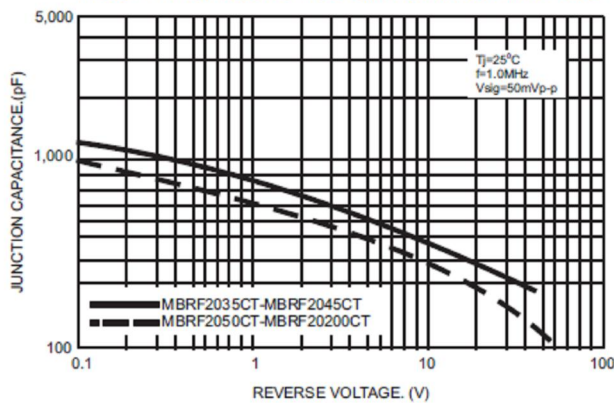
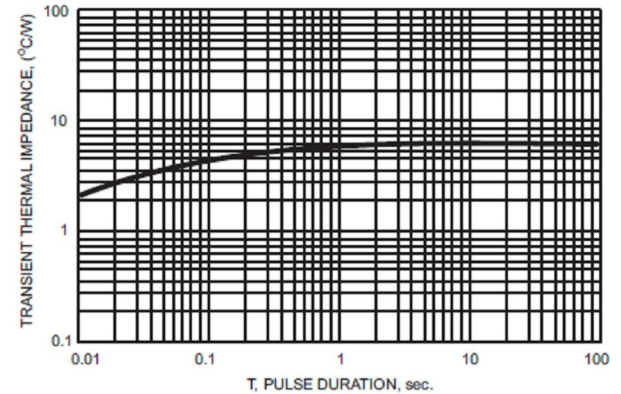

FIG.6- TYPICAL TRANSIENT THERMAL IMPEDANCE PER LEG



Package Outline Dimensions

in millimeters

TO-220-AB

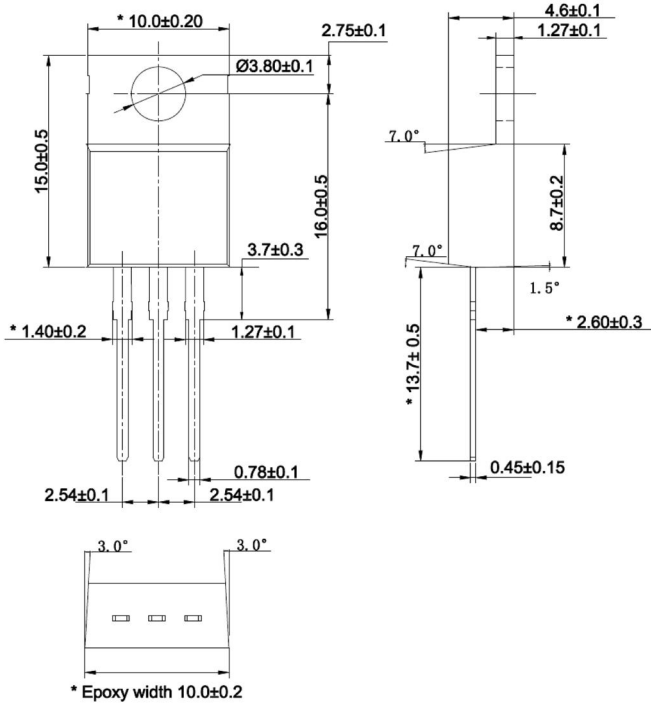

ITO-220-AB

