

## SYNCHRONOUS SEPARATION WITH AFC

### ■ GENERAL DESCRIPTION

The **NJM2229** has functions of getting the horizontal and vertical synchronous signal from the composite video signal by the synchronous separation circuit. Also the **NJM2229** has a detective terminal of the input signal through the synchronous circuit.

### ■ PACKAGE OUTLINE

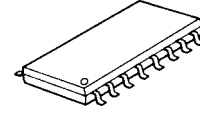

NJM2229M

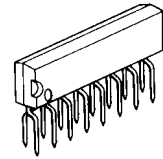

NJM2229S

### ■ FEATURES

- Operating Voltage (+4.7V to +5.3V)
- Internal AFC circuit(Horizontal sync.signal)
- No adjustment of free run frequency.
- Internal detective circuit of sync.signal.
- Package Outline DMP16, ZIP-16
- Bipolar Technology

### ■ RECOMMENDED OPERATING CONDITION

- Operating Voltage 4.75 to 5.3V

### ■ BLOCK DIAGRAM

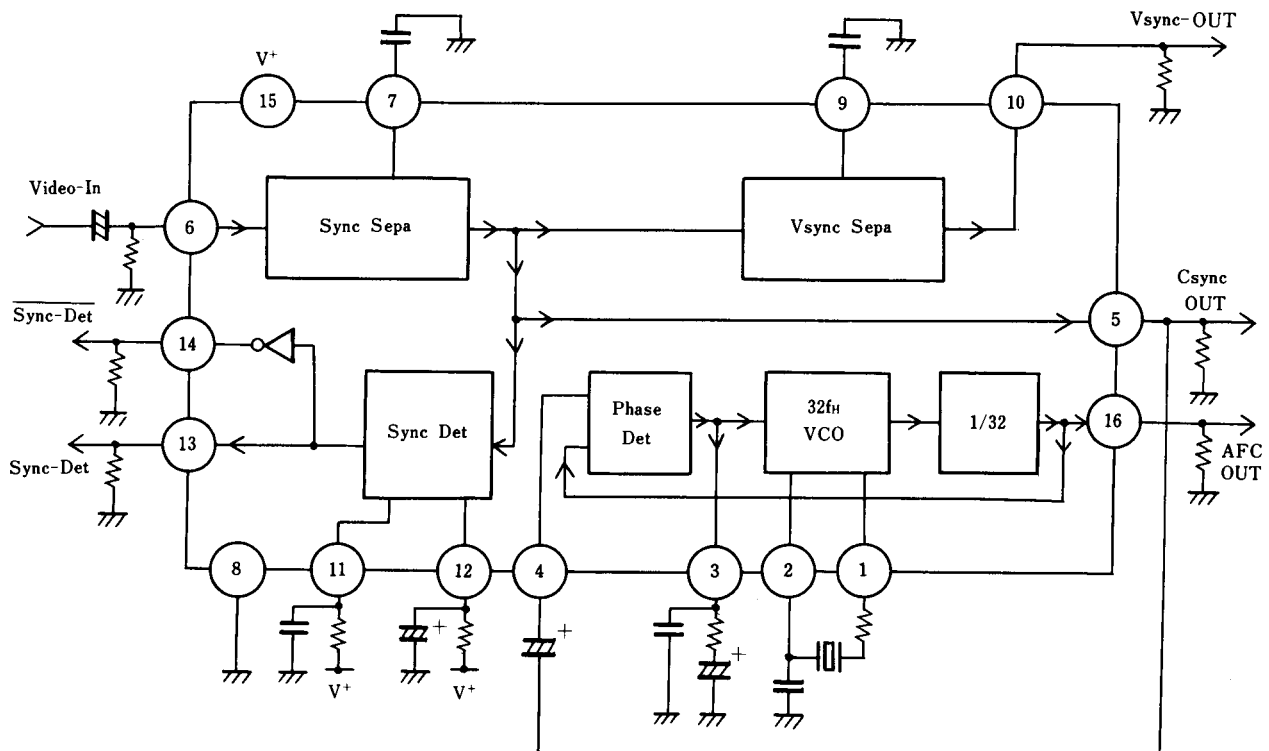

# NJM2229

## ■ ABSOLUTE MAXIMUM RATINGS

(Ta=25°C)

PARAMETER	SYMBOL	RATINGS	UNIT
Supply Voltage	V <sup>+</sup>	7	V
Power Dissipation	P <sub>D</sub>	500	mW
Operating Temperature Range	T <sub>opr</sub>	-20 to +75	°C
Storage Temperature Range	T <sub>stg</sub>	-40 to +125	°C

## ■ ELECTRICAL CHARACTERISTICS

(Ta=25°C, V<sup>+</sup>=5V)

PARAMETER	SYMBOL	MIN.	TYP.	MAX.	UNIT
Operating Current	I <sub>CC</sub>	-	20	26	mA
AFC Free-run Frequency	f <sub>OH</sub>	15.534	15.734	15.934	KHz
AFC Pulse width	T <sub>HD</sub>	3.7	3.9	4.1	μs
AFC Delay	T <sub>HA</sub>	0.7	1.7	2.7	μs
AFC Lock Range	Δf <sub>HL</sub>	+600 -900	+700 -1000	- -	Hz
AFC Capture Range	Δf <sub>HP</sub>	+400 -700	+600 -900	- -	Hz
AFC Output Voltage High	V <sub>HAH</sub>	4.0	4.2	-	V
AFC Output Voltage Low	V <sub>HAL</sub>	-	0	0.1	V
Sync. Signal Detection Level	V <sub>HDS</sub>	0.11	0.14	0.17	V
Sync. Signal Detection Delay time	V <sub>HDC</sub>	0	0.57	1.5	μs
Sync. Signal Detection Output voltage High	V <sub>HDH</sub>	4.0	4.2	-	V
Sync. Signal Detection Output voltage Low	V <sub>HDL</sub>	-	0	0.1	V
V <sub>SYNC</sub> Threshold Voltage High	V <sub>DSH</sub>	2.4	2.5	2.6	V
V <sub>SYNC</sub> Threshold Voltage Low	V <sub>DSL</sub>	1.4	1.5	1.6	V
V <sub>SYNC</sub> Output voltage High	V <sub>DH</sub>	4.0	4.2	-	V
V <sub>SYNC</sub> Output voltage Low	V <sub>DL</sub>	-	0	0.1	V
V <sub>SYNC</sub> Pulse Width	T <sub>VD</sub>	212	272	332	μs
V <sub>SYNC</sub> Delay Time	T <sub>VDT</sub>	9.6	12.3	15	μs
Sync. Detection Lock Voltage High	V <sub>LH</sub>	2.53	2.68	2.83	V
Sync. Detection Lock Voltage Low	V <sub>LL</sub>	1.25	1.40	1.55	V
Sync. Detection Capture High	V <sub>CH</sub>	2.07	2.22	2.37	V
Sync. Detection Capture Low	V <sub>CL</sub>	1.57	1.72	1.87	V
Sync. Detection Output voltage High	V <sub>DEH</sub>	4.0	4.2	-	V
Sync. Detection Output voltage Low	V <sub>DEL</sub>	-	0	0.1	V
Sync. Detection Output voltage High	V <sub>DEH</sub>	4.0	4.2	-	V
Sync. Detection Output voltage Low	V <sub>DEL</sub>	-	0	0.1	V



# NJM2229

## ■ ELECTRICAL PARAMETER TEST METHOD

Test circuit

PARAMETER	SW-1	SW-2	SW-3	TEST CONDITION.
Operating Current	A	A	A	No input signal. DC current at Pin 15.
AFC Free-run Frequency	A	A	A	No input signal. Video-IN terminal to GND. Frequency at Pin 16.
AFC pulse Width	A	A	A	No input signal. Output Pulse width at Pin 16. (Note 1)
AFC Output Delay Time	A	A	A	Input 2Vp-p video signal on Video-IN terminal. Delay time between input and AFC output signal. (Note 1)
AFC Lock Range	A	A	A	Operating frequency range of AFC output when the input Pulse signal frequency with 5 μsec pulse width at Video-IN terminal changes.
AFC Capture Range	A	A	A	Frequency range when signal changes from AFC unlock condition to lock.
AFC Output Voltage	A	A	A	Output voltage at Pin 16 in condition of load resistance $R_L=10k\Omega$
Sync. Signal Detection level	A	A	A	Putting 2Vp-p video signal on Video-IN terminal and reducing it to the level that pin5 output waveform is beginning to change. $V_{HDS}$ is the sink-chip level at that point. (Note 2)
Sync. Signal Detection Output Voltage	A	A	A	Output voltage at Pin5 with load resistance $R_L=10k\Omega$ .
Sync. Signal Detection Delay time	A	A	A	2Vp-p video signal at Video-IN terminal. Time difference between input(Pin5) and output(Pin6) waveform.
$V_{SYNC}$ Threshold Voltage High	B	A	A	Gradually increase DC voltage from 2V to 3V at $V_{SYNC-IN}$ terminal. DC input voltage when output voltage at Pin10 changes from Low to High state.
$V_{SYNC}$ Threshold Voltage Low	B	A	A	Gradually decrease DC voltage from 3V to 1V at $V_{SYNC-IN}$ terminal. DC input voltage when output voltage at Pin10 changes from High to Low state.
$V_{SYNC}$ Output Voltage	B	A	A	Output voltage at Pin10 with load resistance $R_L=10k\Omega$
$V_{SYNC}$ Pulse Width	A	A	A	Putting 2Vp-p video signal on Video-IN terminal and measuring output pulse width at Pin10. (Note 3)
$V_{SYNC}$ Delay Time	A	A	A	Putting 2Vp-p video signal on Video-IN terminal Delay time between output at Pin10 and $V_{SYNC}$ at Pin6. (Note 3)
Sync. Detection Lock Voltage High	A	B	B	Increase DC voltage from 2V to 4V put on Sync-Det-IN terminal and measure its DC voltage when output voltage at Pin13 changes from HIGH to Low. (Note 4)
Sync. Detection Lock Voltage Low	A	B	B	Decrease DC voltage from 2V to 1V put on Sync-Det-IN terminal and measure its DC voltage when output voltage at Pin13 changes from HIGH to Low. (Note 4)
Sync. Detection Capture High	A	B	B	Decrease DC voltage from 3V to 1V put on Sync-Det-IN terminal and measure its DC voltage when output voltage at Pin13 changes from Low to HIGH. (Note 4)
Sync. Detection Capture Low	A	B	B	Increase DC voltage from 1V to 2V put on Sync-Det-IN terminal and measure its DC voltage when output voltage at Pin13 changes from Low to HIGH. (Note 4)
Sync. Detection Output Voltage	A	B	B	Output voltage at Pin13 with load resistance $R_L=10k\Omega$ .
Sync. Detection Output Voltage	A	B	B	Output voltage at Pin14 with load resistance $R_L=10k\Omega$ .

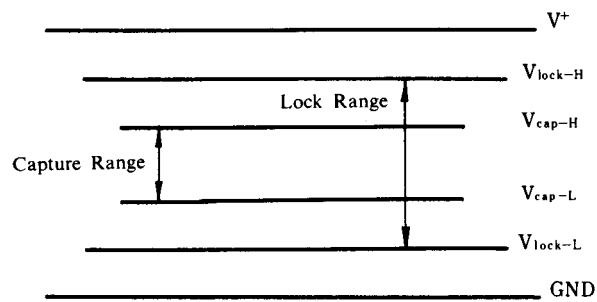
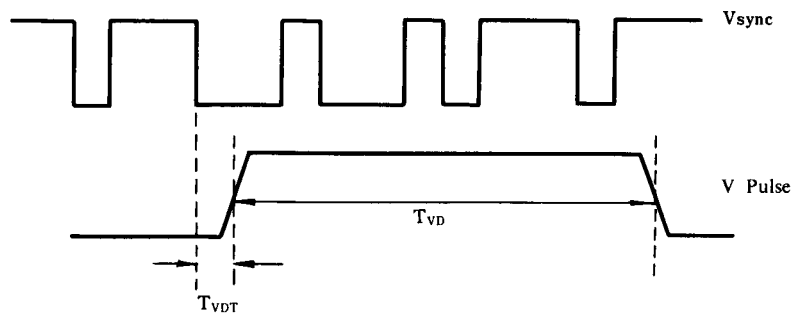
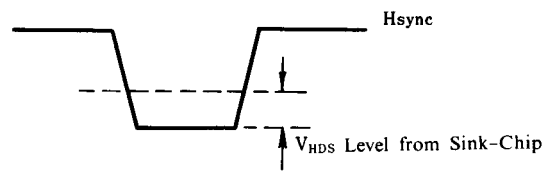
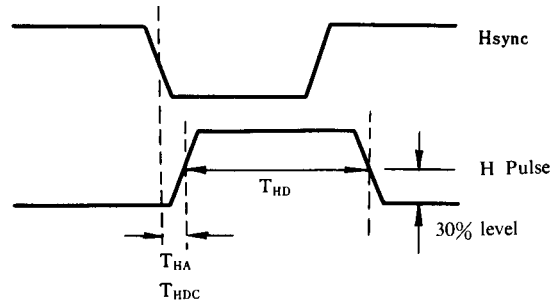

# NJM2229

## ■ PIN FUNCTION

PIN NO.	SYMBOL	FUNCTION	INSIDE EQUIVALENT CIRCUIT
1	VCO-OUT	Putting VCO output on ceramic resonator.	
2	VCO-FILTER	Deciding phase of ceramic resonator.	
3	AFC-FILTER	Low pass filter of AFC	
4	AFC-IN	Input terminal of AFC. Putting composite. Synchronous signal on it.	
5	C.SYNC-OUT	Sync. signal Detection output	

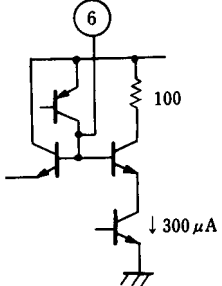
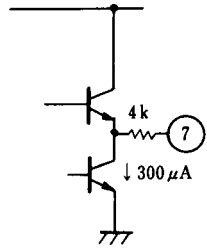
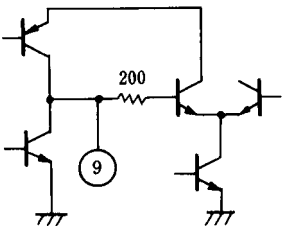
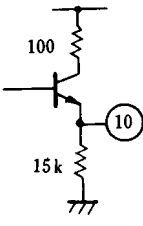
PIN NO.	SYMBOL	FUNCTION	INSIDE EQUIVALENT CIRCUIT
6	VIDEO-IN	Input composite video signal.	
7	L. P. F	Low pass filter for chroma signal.	
8	GND	Ground.	
9	SYNC-INTEGR	Integrating composite synchronous signal and putting vertical synchronous reproducing circuit.	
10	VSYNC-OUT	Vertical synchronous output	

# NJM2229

PIN NO.	SYMBOL	FUNCTION	INSIDE EQUIVALENT CIRCUIT
11	M. M-TC	Deciding time constant of M. M. V. (monomulti vibrator)	
12	M. M-INTER	Smoothing M. M. V. output.	
13	SYNCDET-OUT	Signal detective output.	
14	$\overline{\text{SYNCDET}} - \text{OUT}$	Inversed output of Pin13.	
15	V <sup>+</sup>	Power supply.	
16	AFC-OUT	AFC output.	



**[CAUTION]**

The specifications on this databook are only given for information, without any guarantee as regards either mistakes or omissions. The application circuits in this databook are described only to show representative usages of the product and not intended for the guarantee or permission of any right including the industrial rights.