

NTMFD4C20N

MOSFET – Power, Dual, N-Channel, SO8FL

30 V, High Side 18 A / Low Side 27 A

Features

- Co-Packaged Power Stage Solution to Minimize Board Space
- Minimized Parasitic Inductances
- Optimized Devices to Reduce Power Losses
- These Devices are Pb-Free, Halogen Free/BFR Free and are RoHS Compliant

Applications

- DC-DC Converters
- System Voltage Rails
- Point of Load



ON Semiconductor®

www.onsemi.com

V _{(BR)DSS}	R _{DS(ON)} MAX	I _D MAX
Q1 Top FET 30 V	7.3 mΩ @ 10 V	18 A
	10.8 mΩ @ 4.5 V	
Q2 Bottom FET 30 V	3.4 mΩ @ 10 V	27 A
	5.2 mΩ @ 4.5 V	

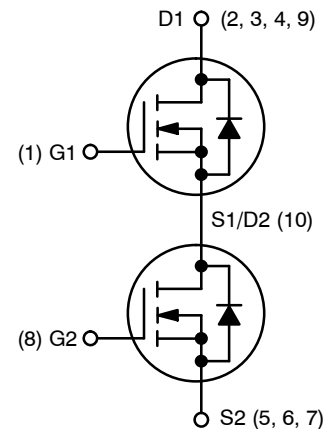

PIN CONNECTIONS

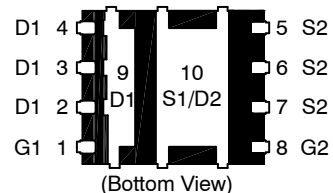

MARKING DIAGRAM

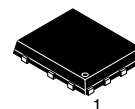

DFN8
CASE 506BX

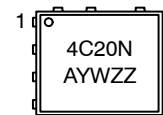

4C20N = Specific Device Code
 A = Assembly Location
 Y = Year
 W = Work Week
 ZZ = Lot Traceability

ORDERING INFORMATION

See detailed ordering and shipping information in the package dimensions section on page 5 of this data sheet.

NTMFD4C20N

MAXIMUM RATINGS ($T_J = 25^\circ\text{C}$ unless otherwise stated)

Parameter			Symbol	Value	Unit
Drain-to-Source Voltage	Q1		V_{DSS}	30	V
Drain-to-Source Voltage	Q2				
Gate-to-Source Voltage	Q1		V_{GS}	± 20	V
Gate-to-Source Voltage	Q2				
Continuous Drain Current $R_{\theta JA}$ (Note 1)		$T_A = 25^\circ\text{C}$	Q1	12	A
		$T_A = 25^\circ\text{C}$	Q1	8.6	
		$T_A = 85^\circ\text{C}$	Q2	13	
Power Dissipation $R_{\theta JA}$ (Note 1)		$T_A = 25^\circ\text{C}$	Q1	1.88	W
			Q2	1.97	
Continuous Drain Current $R_{\theta JA} \leq 10$ s (Note 1)		$T_A = 25^\circ\text{C}$	Q1	18.2	A
		$T_A = 25^\circ\text{C}$	Q1	13.1	
		$T_A = 85^\circ\text{C}$	Q2	19.8	
Power Dissipation $R_{\theta JA} \leq 10$ s (Note 1)		$T_A = 25^\circ\text{C}$	Q1	4.37	W
			Q2	4.6	
Continuous Drain Current $R_{\theta JA}$ (Note 2)		$T_A = 25^\circ\text{C}$	Q1	9.1	A
		$T_A = 25^\circ\text{C}$	Q1	6.6	
		$T_A = 85^\circ\text{C}$	Q2	9.9	
Power Dissipation $R_{\theta JA}$ (Note 2)		$T_A = 25^\circ\text{C}$	Q1	1.09	W
			Q2	1.15	
Pulsed Drain Current		$T_A = 25^\circ\text{C}$ $t_p = 10 \mu\text{s}$	Q1	55	A
			Q2	82	
Operating Junction and Storage Temperature			Q1	T_J, T_{STG}	-55 to $+150$
			Q2		
Source Current (Body Diode)			Q1	4.0	A
			Q2	4.2	
Drain to Source DV/DT			dV/dt	6	V/ns
Single Pulse Drain-to-Source Avalanche Energy ($T_J = 25^\circ\text{C}$, $V_{DD} = 50$ V, $V_{GS} = 10$ V, $L = 0.1$ mH, $R_G = 25 \Omega$)	$I_L = 18 A_{pk}$	Q1	EAS	16	mJ
	$I_L = 29 A_{pk}$	Q2	EAS	42	
Lead Temperature for Soldering Purposes (1/8" from case for 10 s)			T_L	260	$^\circ\text{C}$

Stresses exceeding those listed in the Maximum Ratings table may damage the device. If any of these limits are exceeded, device functionality should not be assumed, damage may occur and reliability may be affected.

- Surface-mounted on FR4 board using 1 sq-in pad, 2 oz Cu.
- Surface-mounted on FR4 board using the minimum recommended pad size of 100 mm².

NTMFD4C20N

THERMAL RESISTANCE MAXIMUM RATINGS

Parameter	FET	Symbol	Value	Unit
Junction-to-Ambient – Steady State (Note 3)	Q1	$R_{\theta JA}$	66.5	°C/W
	Q2		63.3	
Junction-to-Ambient – Steady State (Note 4)	Q1	$R_{\theta JA}$	114.3	
	Q2		108.7	
Junction-to-Ambient – ($t \leq 10$ s) (Note 3)	Q1	$R_{\theta JA}$	28.6	
	Q2		27.2	
Junction-to-Case – (Drain)	Q1	$R_{\theta JC}$	5.4	
	Q2		3.7	

3. Surface-mounted on FR4 board using 1 sq-in pad, 2 oz Cu.

4. Surface-mounted on FR4 board using the minimum recommended pad size of 100 mm².

ELECTRICAL CHARACTERISTICS ($T_J = 25^\circ\text{C}$ unless otherwise specified)

Parameter	FET	Symbol	Test Condition	Min	Typ	Max	Unit
-----------	-----	--------	----------------	-----	-----	-----	------

OFF CHARACTERISTICS

Drain-to-Source Breakdown Voltage	Q1	$V_{(BR)DSS}$	$V_{GS} = 0$ V, $I_D = 250$ μ A	30			V
	Q2		$V_{GS} = 0$ V, $I_D = 1$ mA	30			
Drain-to-Source Breakdown Voltage Temperature Coefficient	Q1	$V_{(BR)DSS}/T_J$			14.5		mV/°C
	Q2				12		
Zero Gate Voltage Drain Current	Q1	I_{DSS}	$V_{GS} = 0$ V, $V_{DS} = 24$ V	$T_J = 25^\circ\text{C}$		1	μ A
				$T_J = 125^\circ\text{C}$		10	
	Q2		$V_{GS} = 0$ V, $V_{DS} = 24$ V	$T_J = 25^\circ\text{C}$		10	
Gate-to-Source Leakage Current	Q1	I_{GSS}	$V_{DS} = 0$ V, $V_{GS} = \pm 20$ V			± 100	nA
	Q2					± 100	

ON CHARACTERISTICS (Note 5)

Gate Threshold Voltage	Q1	$V_{GS(TH)}$	$V_{GS} = V_{DS}$, $I_D = 250$ μ A	1.3		2.1	V	
	Q2			1.3		2.1		
Negative Threshold Temperature Coefficient	Q1	$V_{GS(TH)}/T_J$			4.7		mV/°C	
	Q2				5.1			
Drain-to-Source On Resistance	Q1	$R_{DS(on)}$	$V_{GS} = 10$ V	$I_D = 10$ A		5.8	7.3	m Ω
			$V_{GS} = 4.5$ V	$I_D = 10$ A		8.7	10.8	
	Q2		$V_{GS} = 10$ V	$I_D = 20$ A		2.7	3.4	
			$V_{GS} = 4.5$ V	$I_D = 20$ A		4.0	5.2	
Forward Transconductance	Q1	g_{FS}	$V_{DS} = 1.5$ V, $I_D = 10$ A		43		S	
	Q2				68			

5. Pulse Test: pulse width ≤ 300 μ s, duty cycle $\leq 2\%$.

6. Switching characteristics are independent of operating junction temperatures.

NTMFD4C20N

ELECTRICAL CHARACTERISTICS (T_J = 25°C unless otherwise specified)

Parameter	FET	Symbol	Test Condition	Min	Typ	Max	Unit
-----------	-----	--------	----------------	-----	-----	-----	------

CHARGES, CAPACITANCES & GATE RESISTANCE

Input Capacitance	Q1	C _{ISS}	V _{GS} = 0 V, f = 1 MHz, V _{DS} = 15 V		970		pF		
	Q2				1950				
Output Capacitance	Q1	C _{OSS}			430				
	Q2				990				
Reverse Capacitance	Q1	C _{RSS}			125				
	Q2				50				
Total Gate Charge	Q1	Q _{G(TOT)}		V _{GS} = 4.5 V, V _{DS} = 15 V; I _D = 10 A		9.3			nC
	Q2					13			
Threshold Gate Charge	Q1	Q _{G(TH)}			1.6				
	Q2				3.3				
Gate-to-Source Charge	Q1	Q _{GS}			3.3				
	Q2				6.0				
Gate-to-Drain Charge	Q1	Q _{GD}			4.2				
	Q2				3.0				
Total Gate Charge	Q1	Q _{G(TOT)}	V _{GS} = 10 V, V _{DS} = 15 V; I _D = 10 A			19		nC	
	Q2					29			

SWITCHING CHARACTERISTICS (Note 6)

Turn-On Delay Time	Q1	t _{d(ON)}	V _{GS} = 4.5 V, V _{DS} = 15 V, I _D = 15 A, R _G = 3.0 Ω		9.0		ns
	Q2				11		
Rise Time	Q1	t _r			33		
	Q2				32		
Turn-Off Delay Time	Q1	t _{d(OFF)}			15		
	Q2				20		
Fall Time	Q1	t _f			5.0		
	Q2				5.0		

SWITCHING CHARACTERISTICS (Note 6)

Turn-On Delay Time	Q1	t _{d(ON)}	V _{GS} = 10 V, V _{DS} = 15 V, I _D = 15 A, R _G = 3.0 Ω		6.0		ns
	Q2				8.0		
Rise Time	Q1	t _r			26		
	Q2				26		
Turn-Off Delay Time	Q1	t _{d(OFF)}			18		
	Q2				25		
Fall Time	Q1	t _f			4.0		
	Q2				4.0		

DRAIN-SOURCE DIODE CHARACTERISTICS

Forward Voltage	Q1	V _{SD}	V _{GS} = 0 V, I _S = 3 A	T _J = 25°C		0.75	1.0	V
				T _J = 125°C		0.62		
	Q2		V _{GS} = 0 V, I _S = 3 A	T _J = 25°C		0.45	0.70	
				T _J = 125°C		0.37		

5. Pulse Test: pulse width ≤ 300 μs, duty cycle ≤ 2%.

6. Switching characteristics are independent of operating junction temperatures.

NTMFD4C20N

ELECTRICAL CHARACTERISTICS (T_J = 25°C unless otherwise specified)

Parameter	FET	Symbol	Test Condition	Min	Typ	Max	Unit
DRAIN-SOURCE DIODE CHARACTERISTICS							
Reverse Recovery Time	Q1	t _{RR}	V _{GS} = 0 V, d _{IS} /d _t = 100 A/μs, I _S = 30 A		23		ns
	Q2				38		
Charge Time	Q1	t _a			11.6		
	Q2				18.6		
Discharge Time	Q1	t _b			11.4		
	Q2				19.4		
Reverse Recovery Charge	Q1	Q _{RR}			10		nC
	Q2				25		

PACKAGE PARASITIC VALUES

Source Inductance	Q1	L _S	T _A = 25°C		0.38		nH	
	Q2				0.65			
Drain Inductance	Q1	L _D			0.054		nH	
	Q2				0.007			
Gate Inductance	Q1	L _G			1.5		nH	
	Q2				1.5			
Gate Resistance	Q1	R _G			0.3	1.0	2.0	Ω
	Q2				0.3	1.0	2.0	

5. Pulse Test: pulse width ≤ 300 μs, duty cycle ≤ 2%.

6. Switching characteristics are independent of operating junction temperatures.

ORDERING INFORMATION

Device	Package	Shipping [†]
NTMFD4C20NT1G	DFN8 (Pb-Free)	1500 / Tape & Reel

[†]For information on tape and reel specifications, including part orientation and tape sizes, please refer to our Tape and Reel Packaging Specifications Brochure, BRD8011/D.

NTMFD4C20N

TYPICAL CHARACTERISTICS – Q1

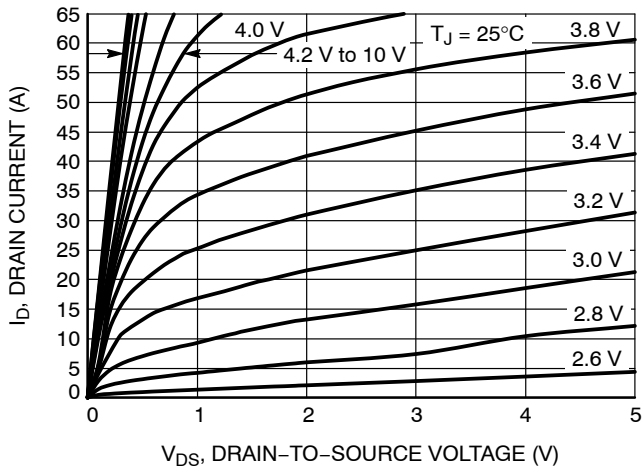

Figure 1. On-Region Characteristics

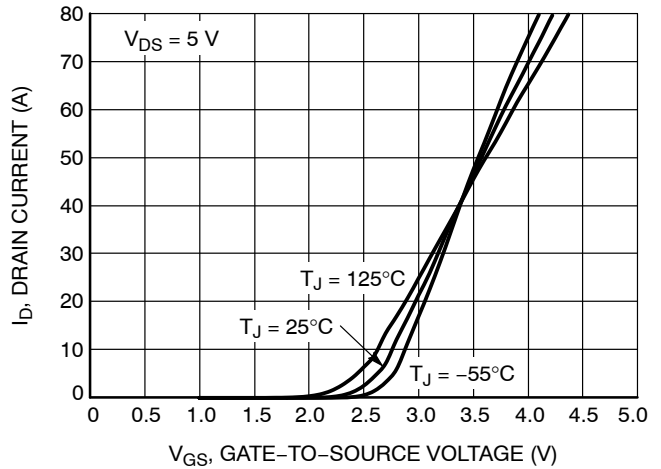

Figure 2. Transfer Characteristics

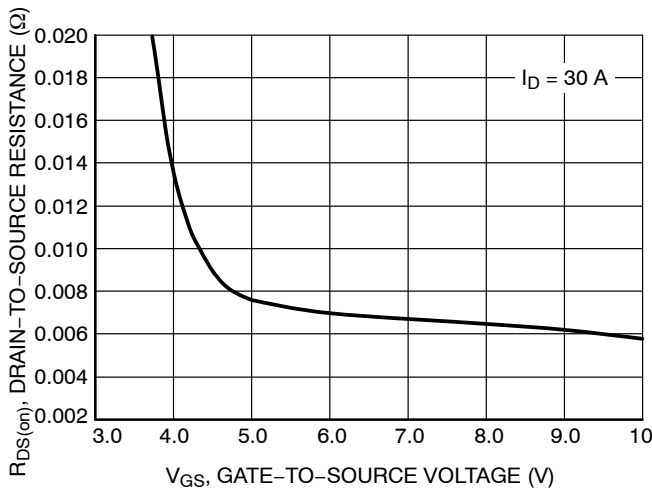

Figure 3. On-Resistance vs. V_{GS}

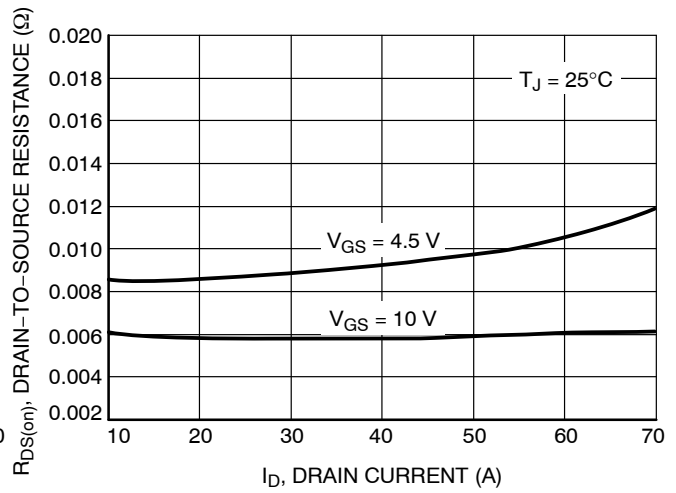

Figure 4. On-Resistance vs. Drain Current and Gate Voltage

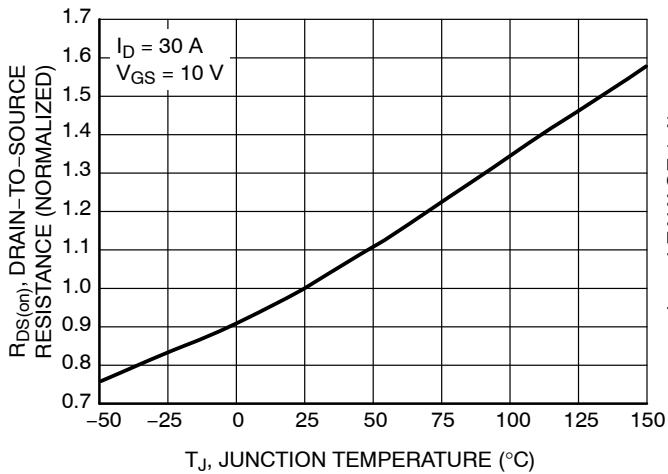

Figure 5. On-Resistance Variation with Temperature

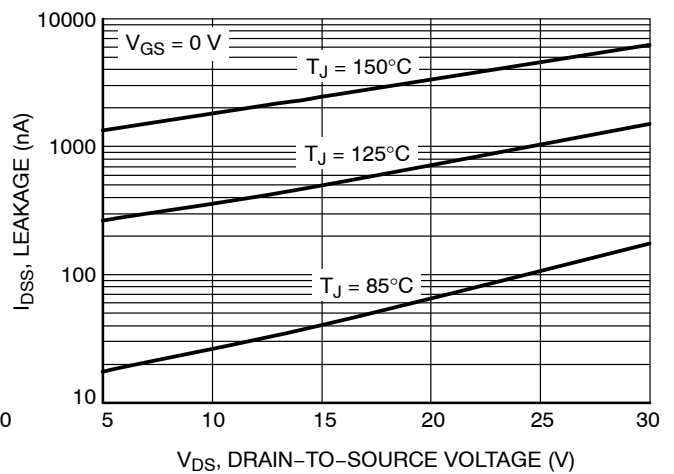

Figure 6. Drain-to-Source Leakage Current vs. Voltage

NTMFD4C20N

TYPICAL CHARACTERISTICS – Q1

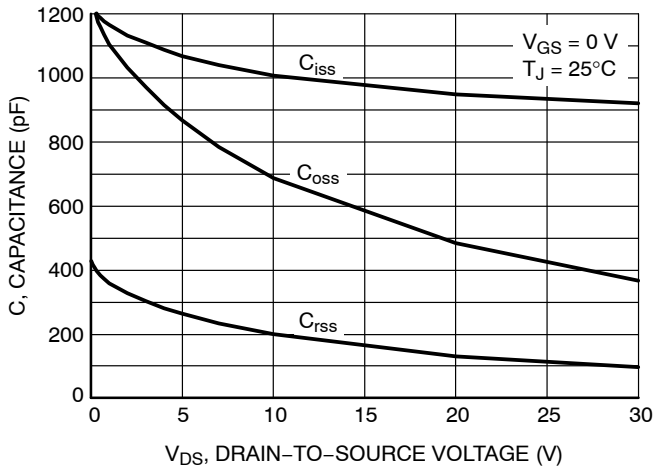

Figure 7. Capacitance Variation

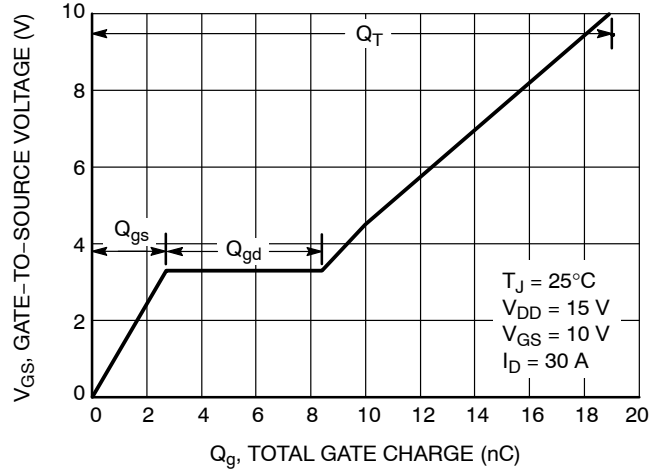

Figure 8. Gate-to-Source and Drain-to-Source Voltage vs. Total Charge

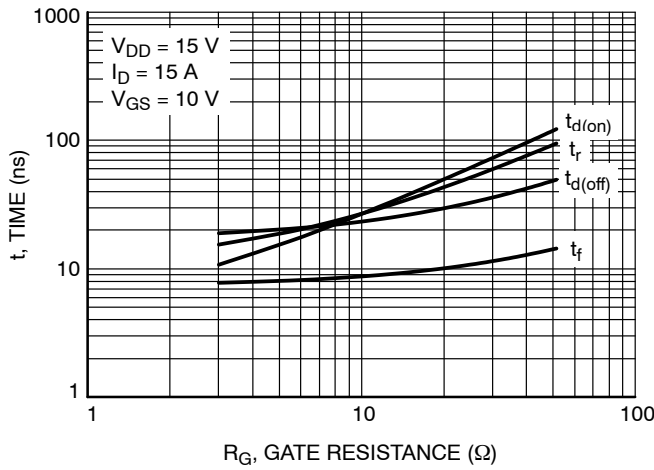

Figure 9. Resistive Switching Time Variation vs. Gate Resistance

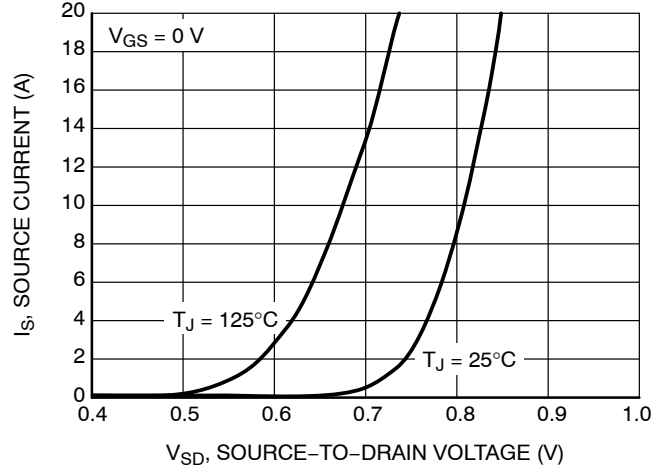

Figure 10. Diode Forward Voltage vs. Current

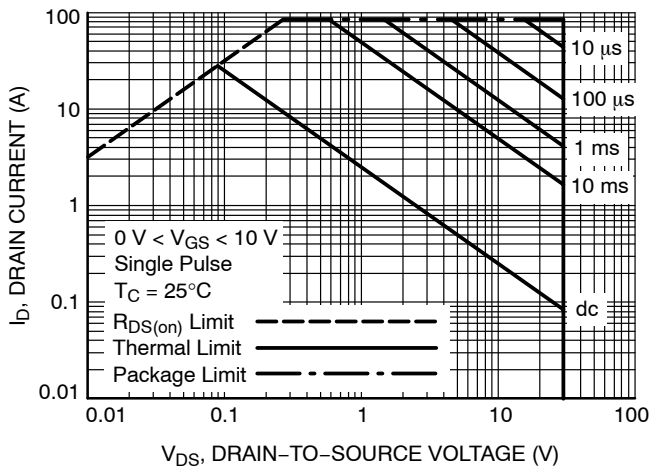

Figure 11. Maximum Rated Forward Biased Safe Operating Area

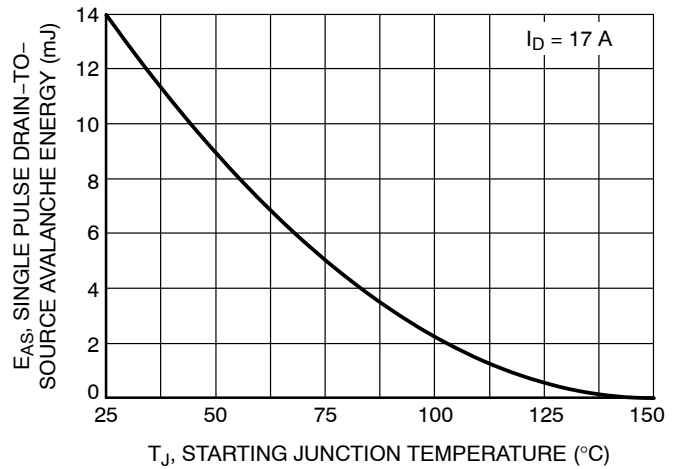

Figure 12. Maximum Avalanche Energy vs. Starting Junction Temperature

NTMFD4C20N

TYPICAL CHARACTERISTICS – Q1

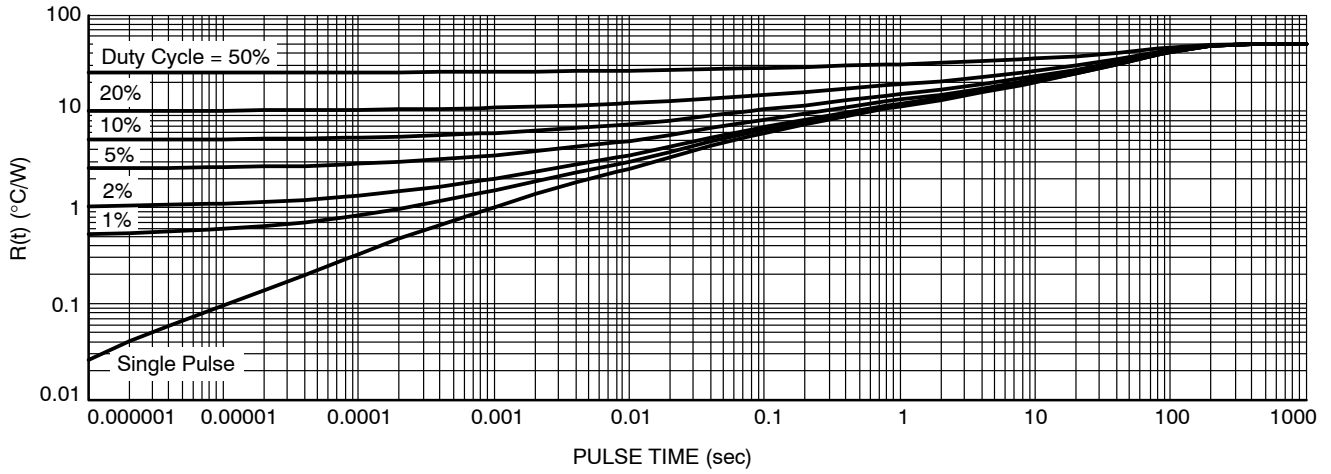

Figure 13. Thermal Response

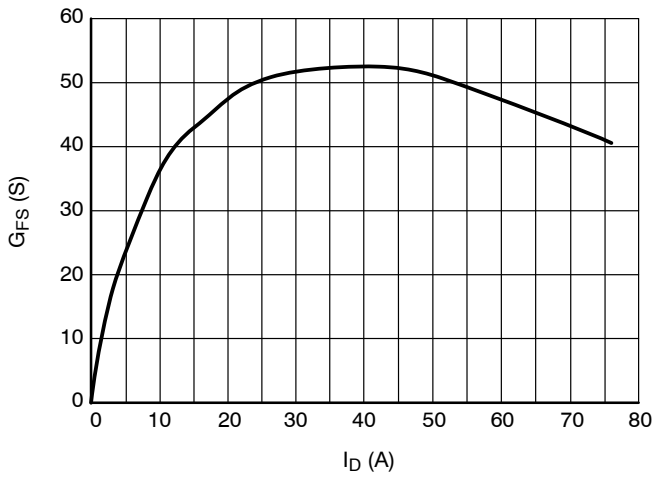

Figure 14. G_{FS} vs. I_D

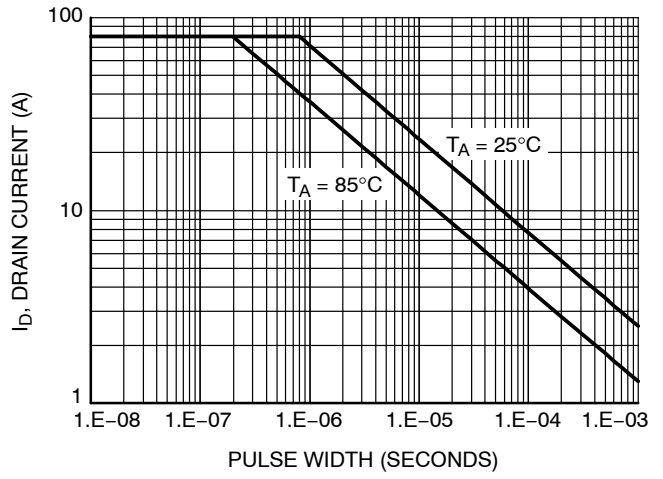

Figure 15. Avalanche Characteristics

NTMFD4C20N

TYPICAL CHARACTERISTICS – Q2

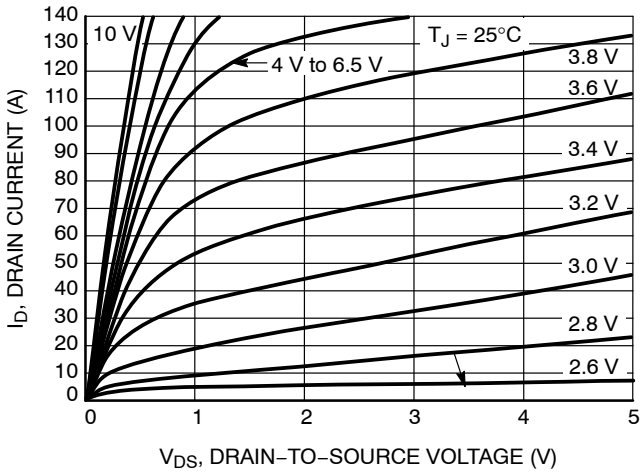

Figure 16. On-Region Characteristics

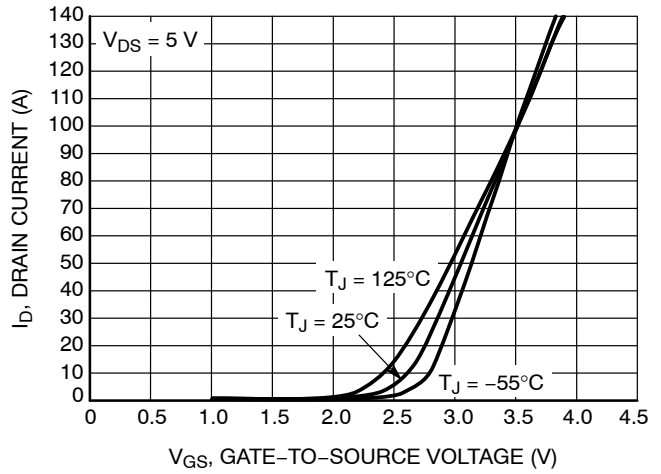

Figure 17. Transfer Characteristics

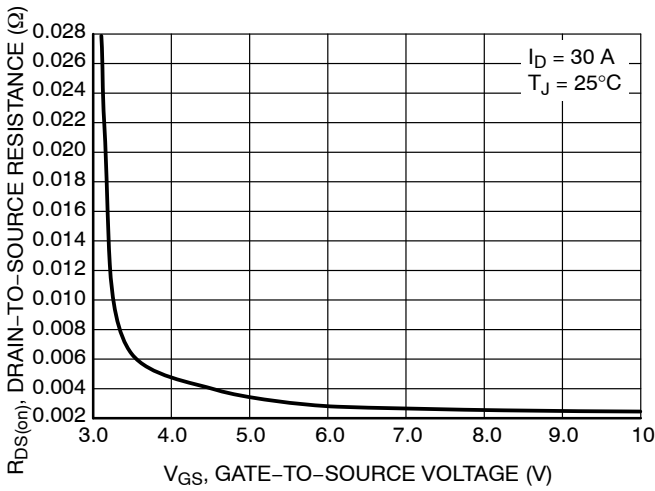

Figure 18. On-Resistance vs. V_{GS}

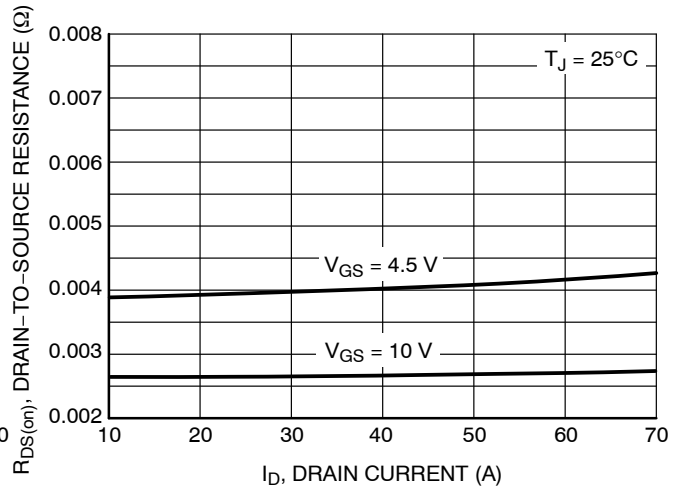

Figure 19. On-Resistance vs. Drain Current and Gate Voltage

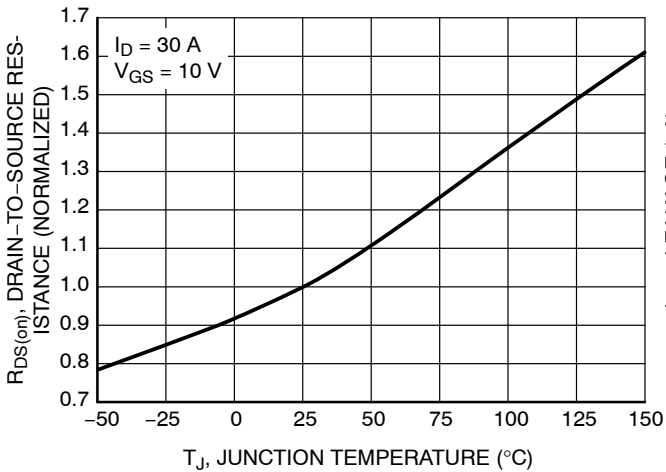

Figure 20. On-Resistance Variation with Temperature

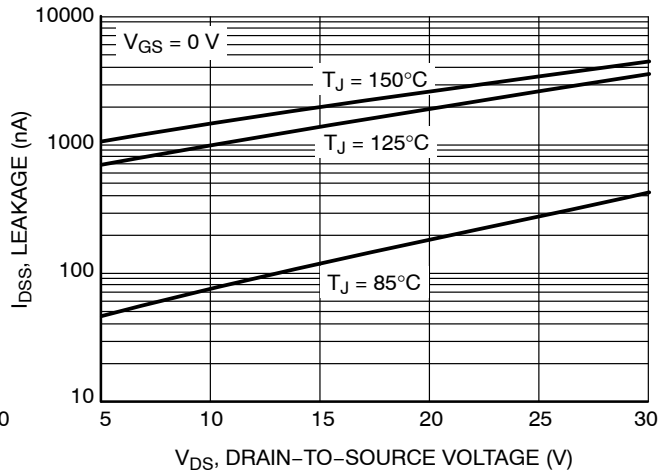

Figure 21. Drain-to-Source Leakage Current vs. Voltage

NTMFD4C20N

TYPICAL CHARACTERISTICS – Q2

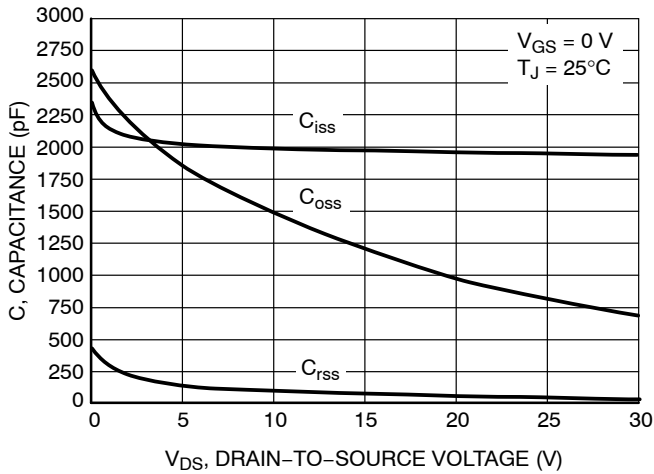

Figure 22. Capacitance Variation

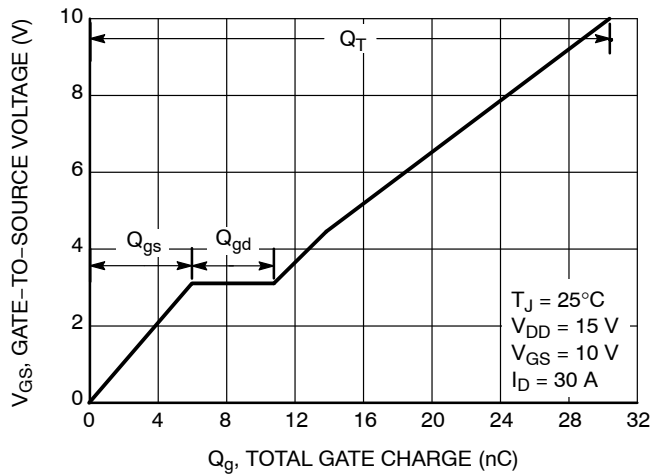

Figure 23. Gate-to-Source and Drain-to-Source Voltage vs. Total Charge

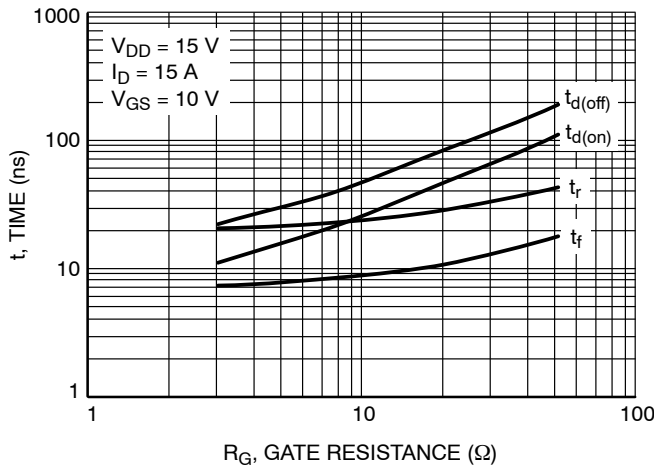

Figure 24. Resistive Switching Time Variation vs. Gate Resistance

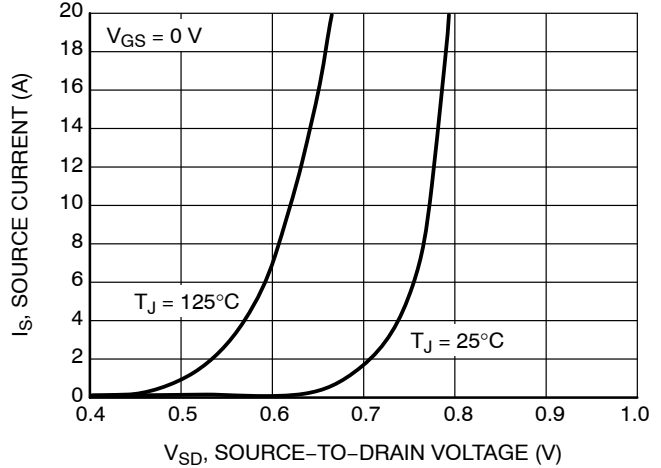

Figure 25. Diode Forward Voltage vs. Current

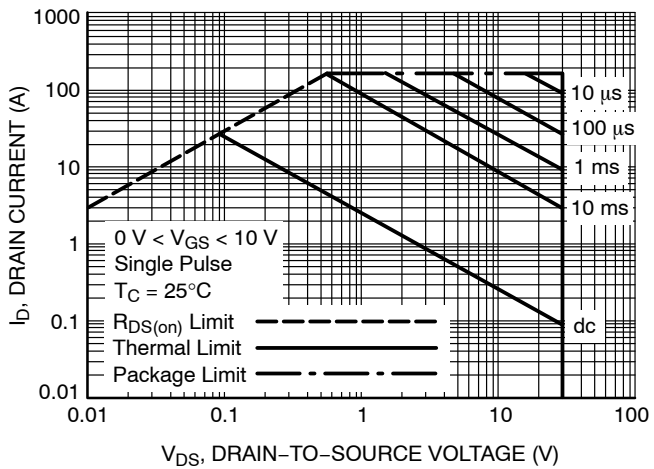

Figure 26. Maximum Rated Forward Biased Safe Operating Area

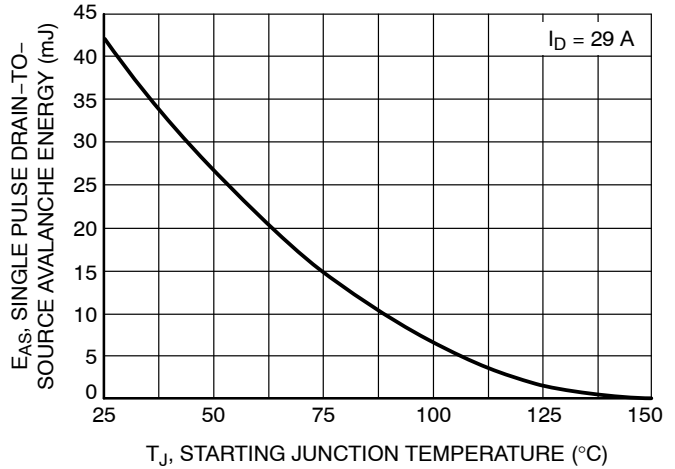

Figure 27. Maximum Avalanche Energy vs. Starting Junction Temperature

NTMFD4C20N

TYPICAL CHARACTERISTICS – Q2

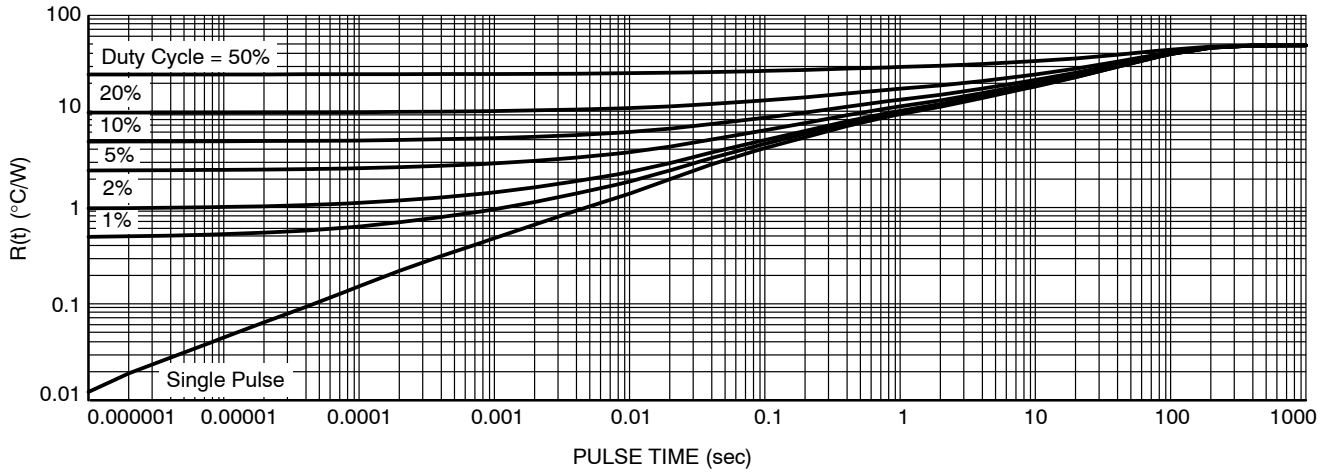

Figure 28. Thermal Response

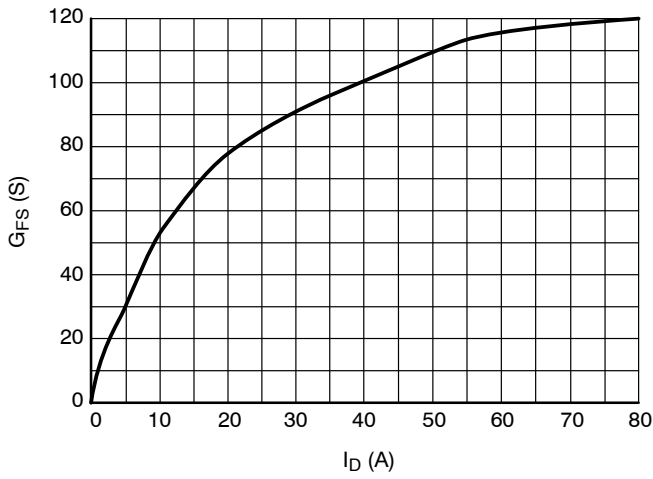

Figure 29. G_{FS} vs. I_D

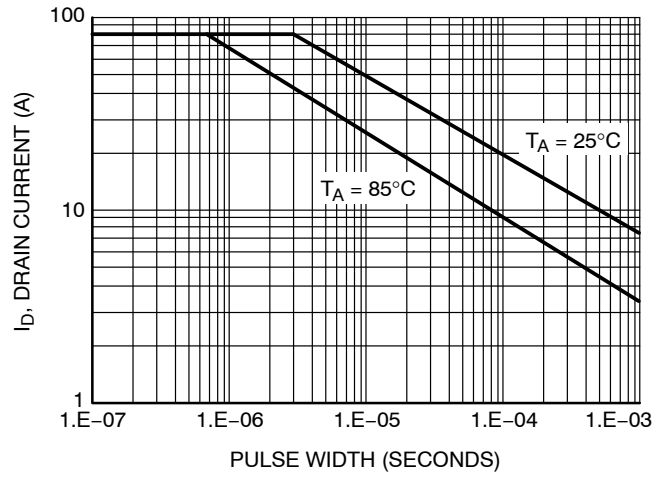
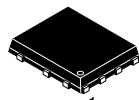

Figure 30. Avalanche Characteristics

MECHANICAL CASE OUTLINE

PACKAGE DIMENSIONS

ON Semiconductor®



SCALE 2:1

DFN8 5x6, 1.27P Dual Flag (SO8FL-Dual-Asymmetrical)

CASE 506BX
ISSUE D

DATE 24 JUN 2014

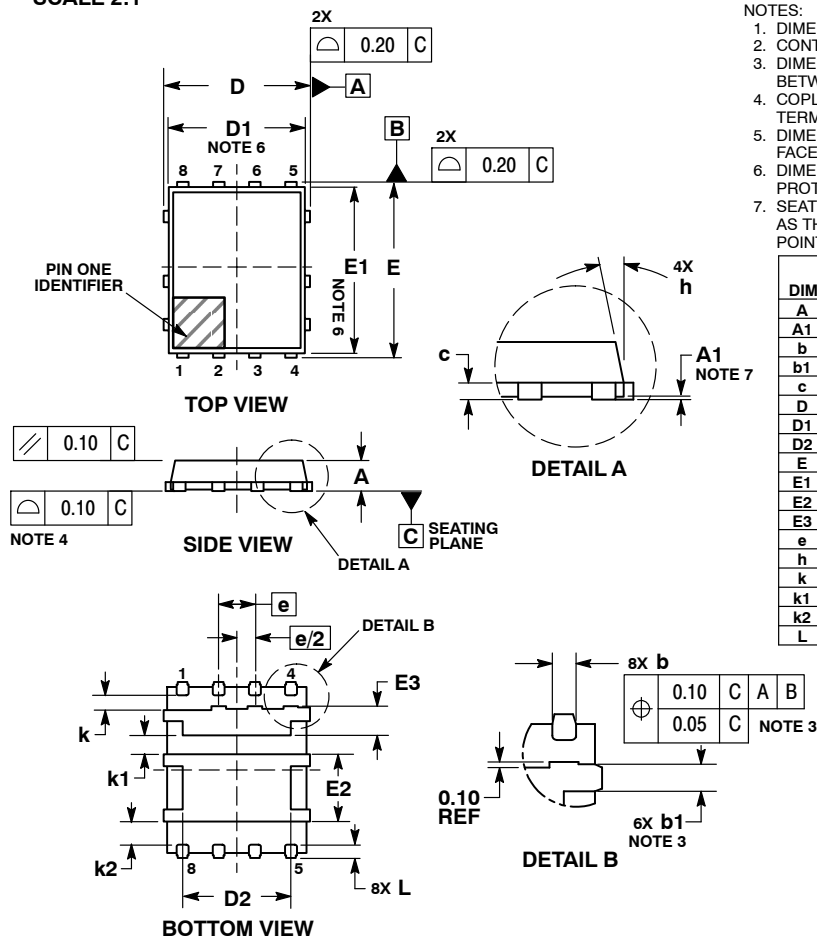

NOTES:

1. DIMENSIONING AND TOLERANCING PER ASME Y14.5M, 1994.
2. CONTROLLING DIMENSION: MILLIMETERS.
3. DIMENSION *b* APPLIES TO PLATED TERMINAL AND IS MEASURED BETWEEN 0.15 AND 0.25 MM FROM THE TERMINAL TIP.
4. COPLANARITY APPLIES TO THE EXPOSED PADS AS WELL AS THE TERMINALS.
5. DIMENSIONS *b* AND *L* ARE MEASURED AT THE PACKAGE SURFACE.
6. DIMENSIONS *D1* AND *E1* DO NOT INCLUDE MOLD FLASH, PROTRUSIONS, OR GATE BURRS.
7. SEATING PLANE IS DEFINED BY THE TERMINALS. *A1* IS DEFINED AS THE DISTANCE FROM THE SEATING PLANE TO THE LOWEST POINT ON THE PACKAGE BODY.

MILLIMETERS		
DIM	MIN	MAX
A	0.90	1.10
A1	0.00	0.05
<i>b</i>	0.41	0.61
<i>b1</i>	0.41	0.61
<i>c</i>	0.23	0.33
D	5.00	5.30
D1	4.50	5.10
D2	3.50	4.22
E	6.00	6.30
E1	5.50	6.10
E2	2.27	2.67
E3	0.82	1.22
<i>e</i>	1.27 BSC	
<i>h</i>	---	12 °
<i>k</i>	0.39	0.59
<i>k1</i>	0.56	0.76
<i>k2</i>	0.73	0.93
<i>L</i>	0.35	0.55

GENERIC MARKING DIAGRAM*



XXXXXX= Specific Device Code
 A = Assembly Location
 Y = Year
 W = Work Week
 ZZ = Lot Traceability

*This information is generic. Please refer to device data sheet for actual part marking.

RECOMMENDED SOLDERING FOOTPRINT*

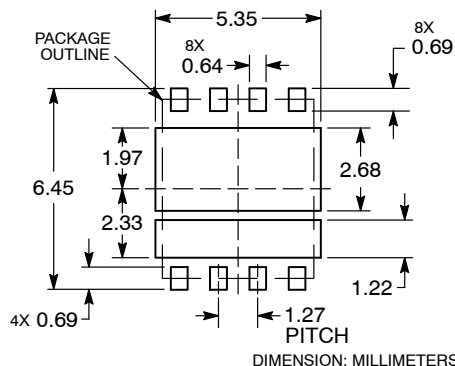

STYLE 1:

- PIN 1. GATE 1
 2. DRAIN 1
 3. DRAIN 1
 4. DRAIN 1
 5. SOURCE 2
 6. SOURCE 2
 7. SOURCE 2
 8. GATE 2
 9. DRAIN 1
 10. SOURCE 1/DRAIN 2

*For additional information on our Pb-Free strategy and soldering details, please download the ON Semiconductor Soldering and Mounting Techniques Reference Manual, SOLDERRM/D.

DOCUMENT NUMBER:	98AON54291E	Electronic versions are uncontrolled except when accessed directly from the Document Repository. Printed versions are uncontrolled except when stamped "CONTROLLED COPY" in red.
DESCRIPTION:	DFN8 5X6, 1.27P DUAL FLAG (SO8FL-DUAL-ASYMMETRICAL)	PAGE 1 OF 1

ON Semiconductor and are trademarks of Semiconductor Components Industries, LLC dba ON Semiconductor or its subsidiaries in the United States and/or other countries. ON Semiconductor reserves the right to make changes without further notice to any products herein. ON Semiconductor makes no warranty, representation or guarantee regarding the suitability of its products for any particular purpose, nor does ON Semiconductor assume any liability arising out of the application or use of any product or circuit, and specifically disclaims any and all liability, including without limitation special, consequential or incidental damages. ON Semiconductor does not convey any license under its patent rights nor the rights of others.

onsemi, **Onsemi**, and other names, marks, and brands are registered and/or common law trademarks of Semiconductor Components Industries, LLC dba "**onsemi**" or its affiliates and/or subsidiaries in the United States and/or other countries. **onsemi** owns the rights to a number of patents, trademarks, copyrights, trade secrets, and other intellectual property. A listing of **onsemi**'s product/patent coverage may be accessed at www.onsemi.com/site/pdf/Patent-Marking.pdf. **onsemi** reserves the right to make changes at any time to any products or information herein, without notice. The information herein is provided "as-is" and **onsemi** makes no warranty, representation or guarantee regarding the accuracy of the information, product features, availability, functionality, or suitability of its products for any particular purpose, nor does **onsemi** assume any liability arising out of the application or use of any product or circuit, and specifically disclaims any and all liability, including without limitation special, consequential or incidental damages. Buyer is responsible for its products and applications using **onsemi** products, including compliance with all laws, regulations and safety requirements or standards, regardless of any support or applications information provided by **onsemi**. "Typical" parameters which may be provided in **onsemi** data sheets and/or specifications can and do vary in different applications and actual performance may vary over time. All operating parameters, including "Typicals" must be validated for each customer application by customer's technical experts. **onsemi** does not convey any license under any of its intellectual property rights nor the rights of others. **onsemi** products are not designed, intended, or authorized for use as a critical component in life support systems or any FDA Class 3 medical devices or medical devices with a same or similar classification in a foreign jurisdiction or any devices intended for implantation in the human body. Should Buyer purchase or use **onsemi** products for any such unintended or unauthorized application, Buyer shall indemnify and hold **onsemi** and its officers, employees, subsidiaries, affiliates, and distributors harmless against all claims, costs, damages, and expenses, and reasonable attorney fees arising out of, directly or indirectly, any claim of personal injury or death associated with such unintended or unauthorized use, even if such claim alleges that **onsemi** was negligent regarding the design or manufacture of the part. **onsemi** is an Equal Opportunity/Affirmative Action Employer. This literature is subject to all applicable copyright laws and is not for resale in any manner.

ADDITIONAL INFORMATION

TECHNICAL PUBLICATIONS:

Technical Library: www.onsemi.com/design/resources/technical-documentation
onsemi Website: www.onsemi.com

ONLINE SUPPORT: www.onsemi.com/support

For additional information, please contact your local Sales Representative at www.onsemi.com/support/sales