

1. Features

- Small footprint Buck converter for up to 1.5A output current application (Output Voltage 2.5V and 3.3V: 800mA output current)
- Low EMI noise using an inductor-embedded ferrite substrate
- High efficiency using synchronous rectifier technology at 3MHz operation
- Fixed output voltage : 1.0, 1.1, 1.2, 1.35, 1.5, 1.8, 2.5, 3.3V (Other output voltage : 50mV step adjustable, factory setting)
- Selectable control mode : PFM/PWM auto mode / Forced PWM mode
- 2.5% DC voltage accuracy over full load current range with PWM mode.
- Wide input voltage range : 2.7~5.5V
- Over current protection, Over temperature protection

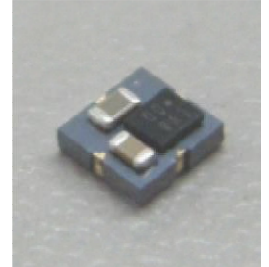

2. Description

The LXDC2XQ series is a step-down DC-DC converter suitable for space-limited or noise-sensitive applications. The device utilizes an inductor-embedded ferrite substrate that reduces radiated EMI noise and conduction noise. By adding input/output capacitors, it can be used as an LDO replacement. Its low noise and easy-to-assemble features assure reliable power supply quality.

New Power Module

The device works in PFM mode at light load for extended battery life. At heavy load, it changes to PWM mode automatically and maintains high efficiency using synchronous rectifying technology.

The device provides good output voltage accuracy even in PFM mode. It maintains 2.5% DC voltage accuracy over the full current range (0-1,500mA), and shows very smooth mode transition between PFM mode and PWM mode.

3. Typical Application Circuit

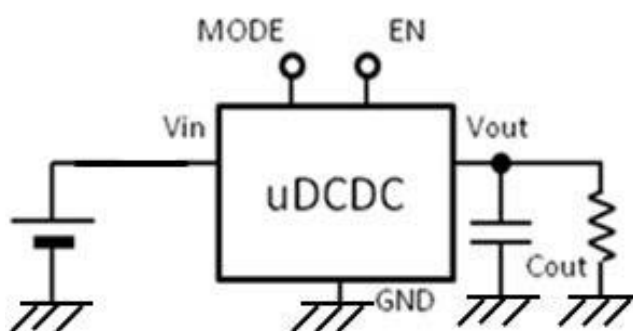

Cout : 10uF/6.3V MLCC (muarta:GRM155B30J106)

4. Mechanical Details 4-1. Outline

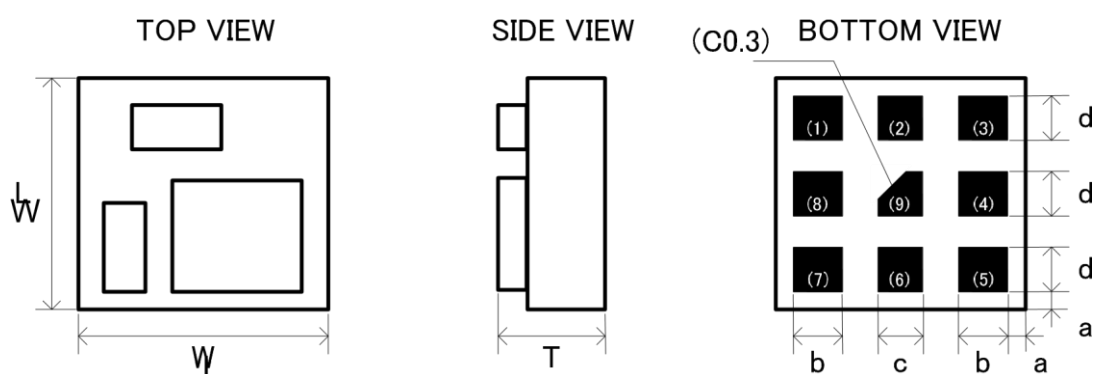

unit:mm

Mark	Dimension	Mark	Dimension
W	2.6 +/- 0.2	a	0.2 +/- 0.2
L	2.8 +/- 0.2	b	0.55 +/- 0.1

T	1.14 MAX	c	0.5 +/- 0.1
		d	0.5 +/- 0.1

4-2. Pin configuration

Pin No.	Symbol	I/O	Description
7	EN	Input	This is the ON/OFF control pin of the device. Connecting this pin to GND keeps the device in shutdown mode. Pulling this pin to Vin enables the device with soft start. This pin must not be left floating and must be terminated. EN=H: Device ON, EN=L: Device OFF
2,3	Vout	Output	Regulated voltage output pin. Apply output load between this pin and GND.
4,8,9	GND	-	Ground pin
5,6	Vin	Input	Vin pin supplies current to the LXDC2XQ internal regulator
1	MODE	Input	This is the operation mode select pin. This pin must not be left floating and must be terminated. Mode=H: Low-noise mode enabled, frequency PWM operation is forced. Mode=L: This device is operating in pulse frequency modulation mode (PFM) at light load currents, and in regulated frequency pulse width mode (PWM) at high-load currents.

4-3. Functional Block Diagram

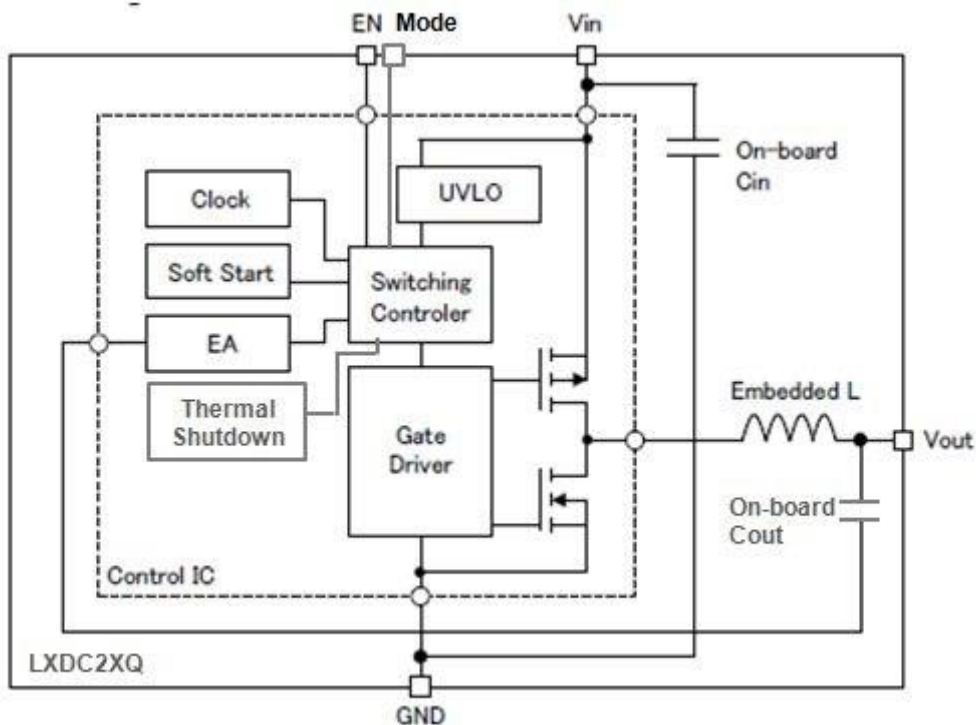

5. Ordering Information

Part number	Output Voltage	Device Specific Feature	MOQ
LXDC2XQ10A-251	1.0V	Standard Type	T/R, 3000pcs/R
LXDC2XQ11A-298	1.1V	Standard Type	T/R, 3000pcs/R
LXDC2XQ12A-252	1.2V	Standard Type	T/R, 3000pcs/R
LXDC2XQ1DA-299	1.35V	Standard Type	T/R, 3000pcs/R
LXDC2XQ15A-277	1.5V	Standard Type	T/R, 3000pcs/R
LXDC2XQ18A-253	1.8V	Standard Type	T/R, 3000pcs/R
LXDC2XQ25A-300	2.5V	Standard Type	T/R, 3000pcs/R
LXDC2XQ33A-254	3.3V	Standard Type	T/R, 3000pcs/R

6. Electrical Specification

6-1 Absolute maximum ratings

Parameter	symbol	rating	Unit
Maximum input voltage	Vin	6.2	V
Maximum EN pin voltage	VEN	6.2	V
Maximum MODE pin voltage	VMODE	6.2	V

New Power Module

Operating Ambient temperature	T _a	-40 to +105	°C
Operating Case Temperature	T _c	-40 to +105	°C

6-2 Electrical characteristics (T_a=25°C)

Parameter	Symbol	Condition	Min.	Typ.	Max.	Unit	
Input voltage	V _{in}		2.7	3.7	5.5	V	
Input leak current	I _{in-off}	V _{in} =3.7V, EN=0V			2	uA	
Output voltage	V _{out}	PFM Mode V _{in} -V _{out} >0.7V	LXDC2XQ10A-251	0.975	1.0	1.035	V
			LXDC2XQ11A-298	1.072	1.1	1.139	
			LXDC2XQ12A-252	1.170	1.2	1.242	
			LXDC2XQ1DA-299	1.316	1.35	1.397	
			LXDC2XQ15A-277	1.462	1.5	1.553	
			LXDC2XQ18A-253	1.755	1.8	1.863	
			LXDC2XQ25A-300	2.437	2.5	2.588	
			LXDC2XQ33A-254	3.218	3.3	3.416	
		PWM Mode V _{in} -V _{out} >0.7V	LXDC2XQ10A-251	0.975	1.0	1.025	
			LXDC2XQ11A-298	1.072	1.1	1.128	
			LXDC2XQ12A-252	1.170	1.2	1.230	
			LXDC2XQ1DA-299	1.316	1.35	1.384	
			LXDC2XQ15A-277	1.462	1.5	1.538	
			LXDC2XQ18A-253	1.755	1.8	1.845	
UVLO	UVLO		1.35	2.0	2.68	V	
Load current range	I _{out}	V _{out} =1.0V, 1.1V, 1.2V, 1.35V, 1.5V, 1.8V	0		1500	mA	
		V _{out} =2.5V, 3.3V	0		800		
Over current protection	OCP	Auto-recovery	1500			mA	
Ripple voltage	V _{rpl}	V _{in} =3.7V, I _{out} =1500mA, BW=150MHz	LXDC2XQ10A-251		15	mV	
			LXDC2XQ11A-298		15		
			LXDC2XQ12A-252		15		
			LXDC2XQ1DA-299		15		
			LXDC2XQ15A-277		15		
			LXDC2XQ18A-253		15		

New Power Module

	Vin=3.7V, Iout=800mA BW=150MHz	LXDC2XQ25A-300		15	
	Vin=5.0V, Iout=800mA, BW=150MHz	LXDC2XQ33A-254		15	

Parameter	Symbol	Condition	Min.	Typ.	Max.	Unit	
Efficiency	EFF	Vin=3.7V, Iout=300mA	LXDC2XQ10A-251		85		%
			LXDC2XQ11A-298		85		
			LXDC2XQ12A-252		86		
			LXDC2XQ1DA-299		87		
			LXDC2XQ15A-277		88		
			LXDC2XQ18A-253		90		
			LXDC2XQ25A-300		93		
		Vin=5.0V, Iout=300mA	LXDC2XQ33A-254		93		
EN control voltage	VENH	ON ; Enable	1.4		Vin	V	
	VENL	OFF ; Disable	0		0.3	V	

6-3 Thermal and Current De-rating Information

The following figures show the power dissipation and temperature rise characteristics. These data are measured on Murata's evaluation board of this device at no air-flow condition.

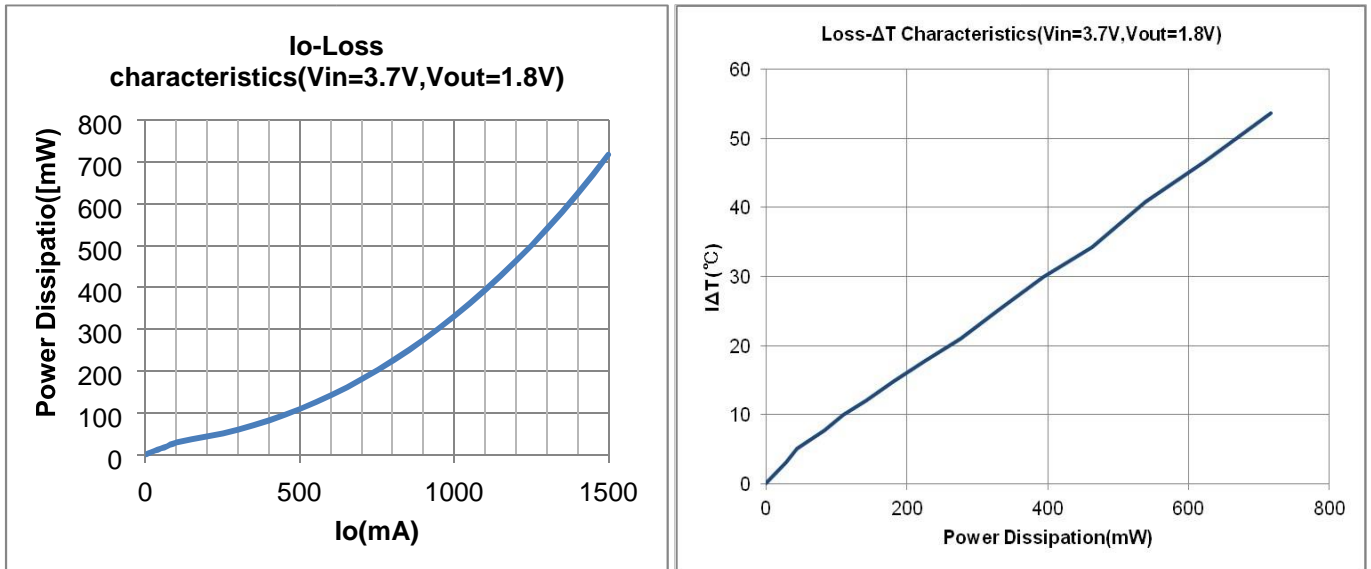

The output current of the device may need to be de-rated if it is operated in a high ambient temperature or in a continuous power delivering application. The amount of current de-rating is highly dependent on the environmental thermal conditions, i.e. PCB design, nearby components or effective air flows. Care should especially be taken in applications where the device temperature exceeds 85°C.

The IC temperature of the device must be kept lower than the maximum rating of 105 °C. It is generally recommended to take an appropriate de-rating to IC temperature for a reliable operation. A general de-rating for the temperature of semiconductor is 80%.

MLCC capacitor's reliability and the lifetime is also dependant on temperature and applied voltage stress. Higher temperature and/or higher voltage cause shorter lifetime of MLCC, and the degradation can be described by the Arrhenius model. The most critical parameter of the degradation is IR (Insulation Resistance). The below figure shows MLCC's B1 life based on a failure rate reaching 1%. It should be noted that wear-out mechanisms in MLCC capacitor is not reversible but cumulative over time.

Vin= 3.7~5.5V, Vout= 1.0, 1.1, 1.2, 1.35, 1.5, 1.8V

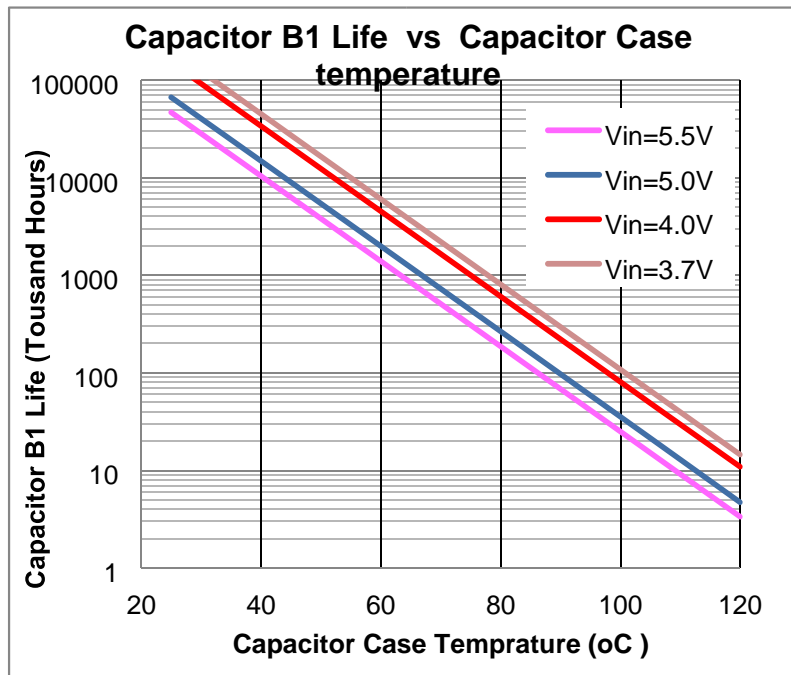

Vin= 5.0~5.5V, Vout=3.3V, 2.5V

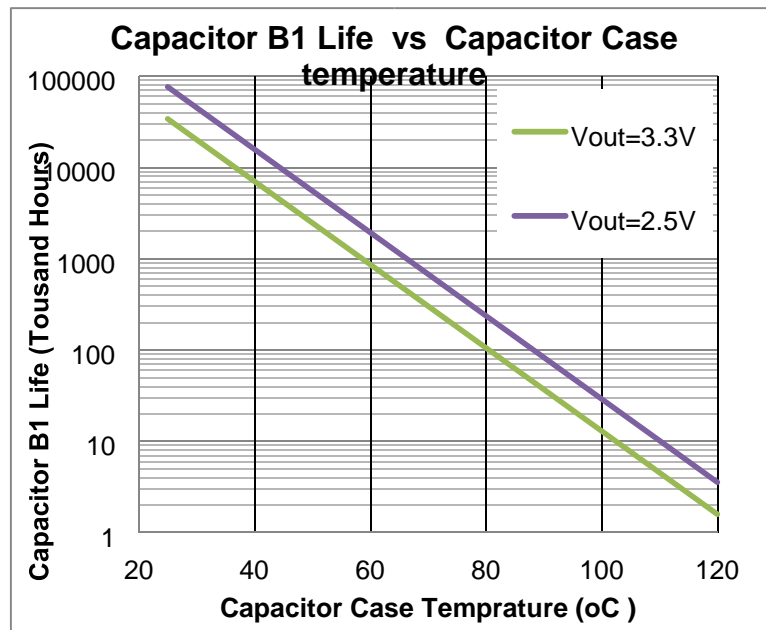

The following steps should be taken before the design fix of user's set for reliable operation.

1. The ambient temperature of the device should be kept below 105 °C
2. The IC temperature should be measured on the worst condition of each application. The temperature must be kept below 105 °C. An appropriate de-rating of temperature and/or output current should be taken.
3. The MLCC temperature should be measured on the worst condition of each application. Considering the above figure, it should be checked if the expected B1 life of MLCC is acceptable or not.

7. Detailed Description PFM/PWM Mode

If the load current decreases, the converter will enter PFM mode automatically. In PFM mode, the device operates in discontinuous current mode with a sporadic switching pulse to keep high efficiency at light load.

The device uses constant on-time control in PFM operation, which produces a low ripple voltage and accurate output voltage compared with other PFM architectures. Because of the architecture, DC output voltage can be kept within +/-2% range of the nominal voltage and the output ripple voltage in PFM mode can be reduced by just increasing the output capacitor.

The transition between PFM and PWM is also seamless and smooth.

The transition current between PFM and PWM is dependent on V_{in} , V_{out} and other factors, but the approximate threshold is about 100-200mA.

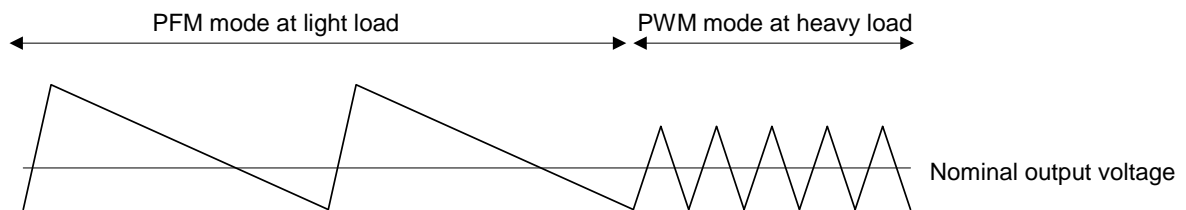

UVLO (Under Voltage Lock Out)

The input voltage (V_{in}) must reach or exceed the UVLO voltage (2.0Vtyp) before the device begins the start up sequence even when the EN pin is kept high. The UVLO function protects against unstable operation at low V_{in} levels .

Soft Start

The device has an internal soft-start function that limits the inrush current during start-up. The soft-start system progressively increases the switching on-time from a minimum pulse-width to that of normal operation. Because of this function, the output voltage increases gradually from zero to nominal voltage at start-up event. The nominal soft-start time is 0.3msec.

Enable

The device starts operation when EN is set high and starts up with soft start. For proper operation, the EN pin must be terminated to logic high and must not be left floating.

Pulling the EN pin to logic low forces the device into shutdown. The device does not have a discharge function when it turns off. If you prefer a discharge function, please contact a Murata representative.

100% Duty Cycle Operation

The device can operate in 100% duty cycle mode, in which the high-side switch is constantly turned ON, thereby providing a low input-to-output voltage difference.

When V_{in} and V_{out} become close and the duty cycle approaches 100%, the switching pulse will skip the nominal switching period and the output voltage ripple may be larger than other conditions. It should be noted that this condition does not mean a failure of the device.

Thermal Shutdown

As soon as internal IC's junction temperature exceeds 150°C(typ), the device goes into thermal shutdown.

The device returns to its normal operation when the internal IC's junction temperature again falls below 120°C(typ).

8. Test Circuit

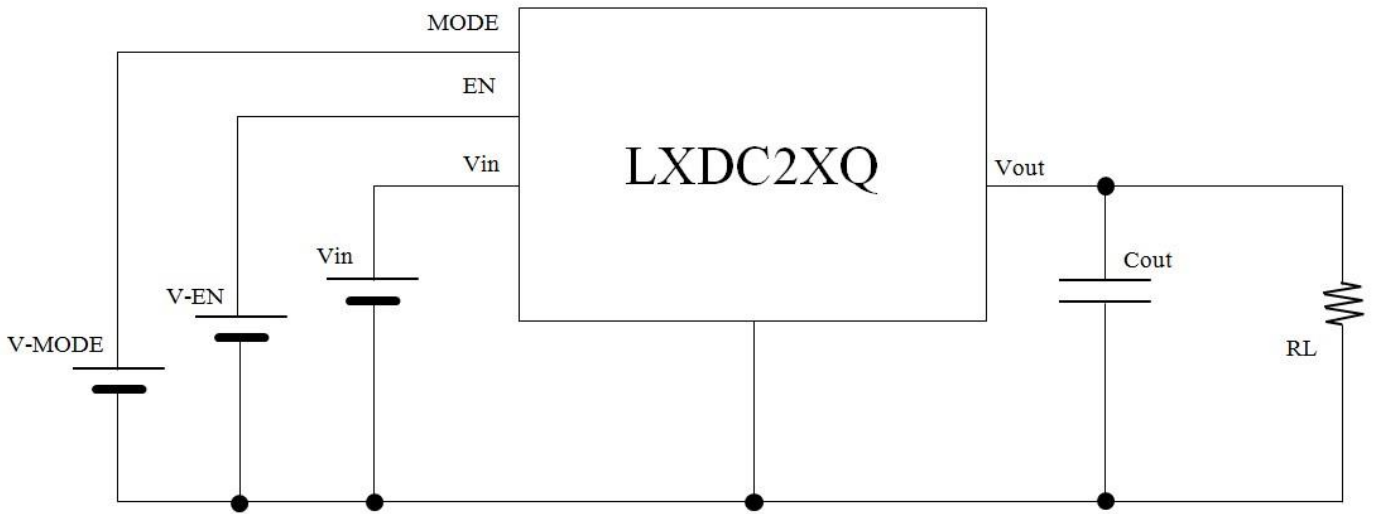

Cout : 10uF/6.3V(GRM155R60J106ME44D)

9. Reference Land Pattern

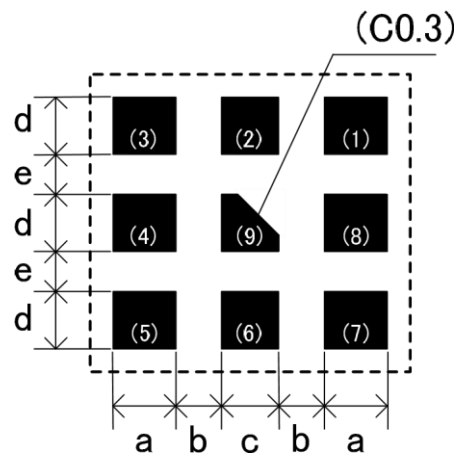

unit (mm)

Mark	Dimension
a	0.65
b	0.3
c	0.6
d	0.6
e	0.3

*Reference purpose only

10. Measurement Data

Micro DC-DC Converter evaluation board (P2LX0244)

Measurement setup

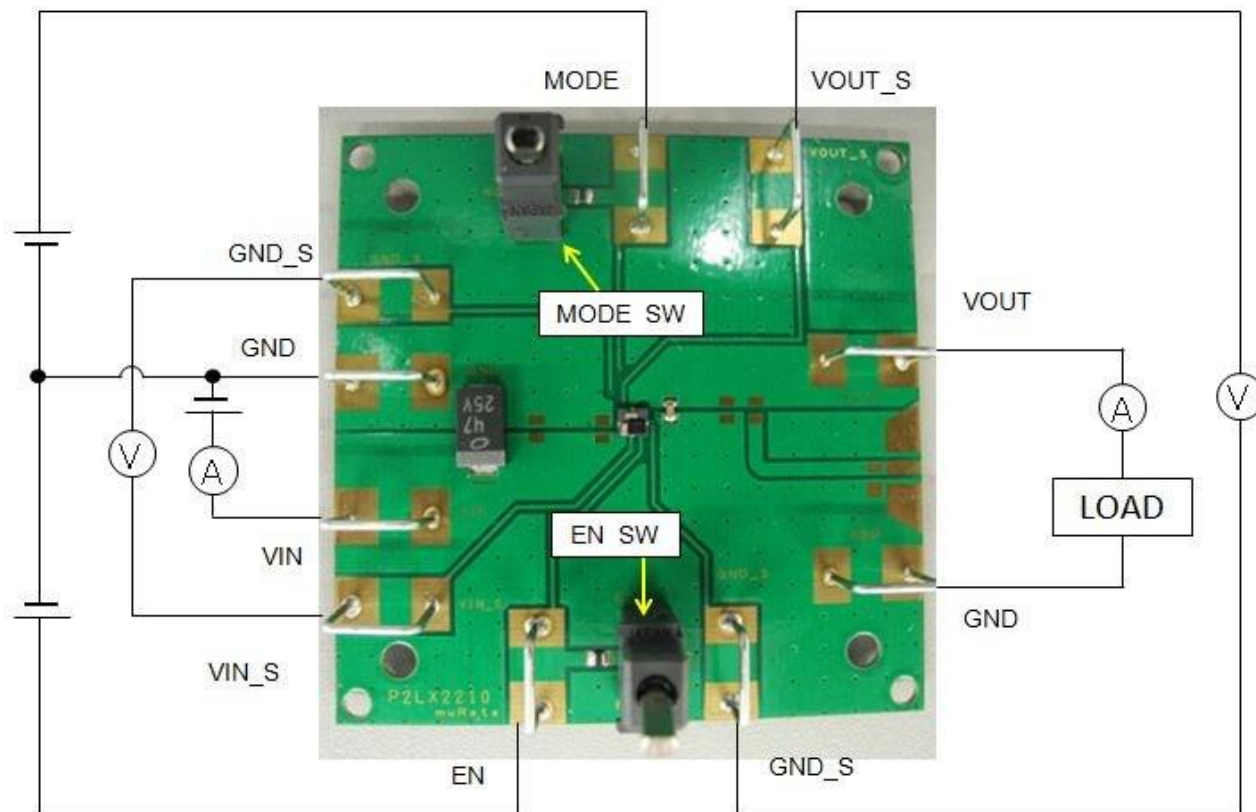

The enable switch has three positions.

1. When it is toggled to “ON” side, the device starts operation.
2. When it is toggled to “OFF” side, the device stops operation and remains in shut down status.
3. When it is set to middle of “ON” and “OFF”, the EN pin floats and an external voltage can be applied to the EN terminal pin on the EVB. If you don't apply an external voltage to EN pin, the enable switch should not be set to the middle position.

The mode switch has three states.

1. When it is toggled to “H” side, the device operates PWM forced mode.
2. When it is toggled to “L” side, the device operates PFM/PWM automatic mode.
3. When it is set to middle of “H” and “OFF”, the mode pin float and an external voltage can be applied to the Mode terminal pin on the EVB. If you don't apply an external voltage to Mode pin, the mode switch should not be set to the middle position.

Typical Measurement Data (reference purpose only)

(Ta=25°C)

Efficiency

• Vin=5.0V, Vout=3.3V

• Vin=3.7V, Vout=1.8V

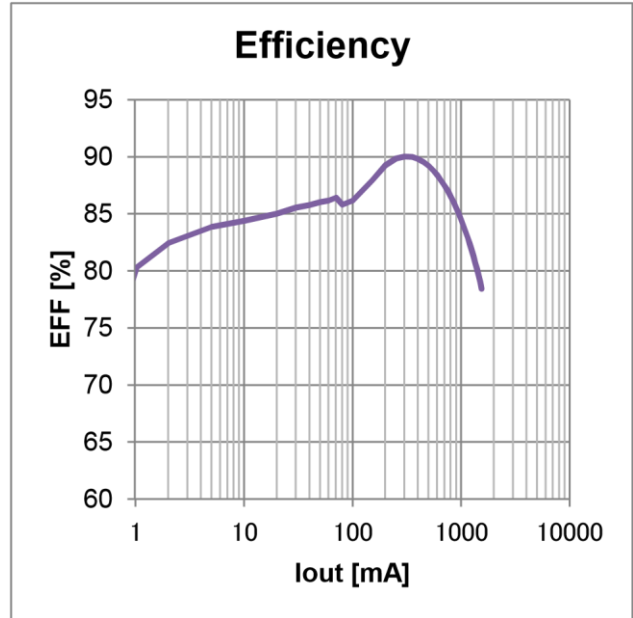
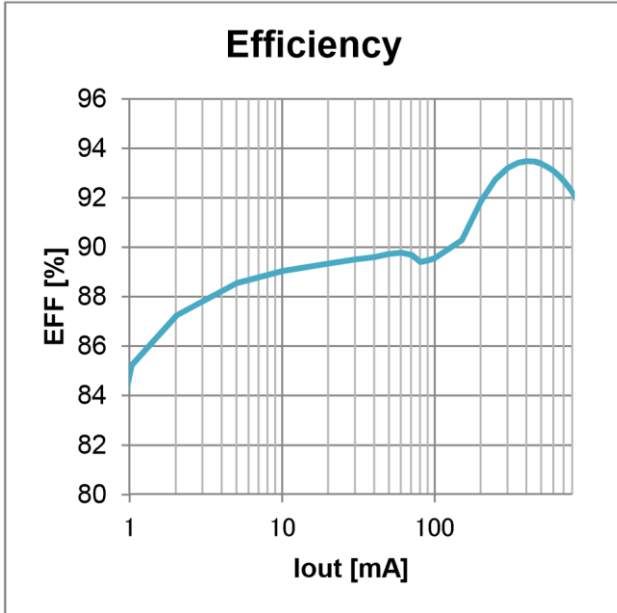

• Vin=3.7V, Vout=1.2V

• Vin=3.7V, Vout=1.0V

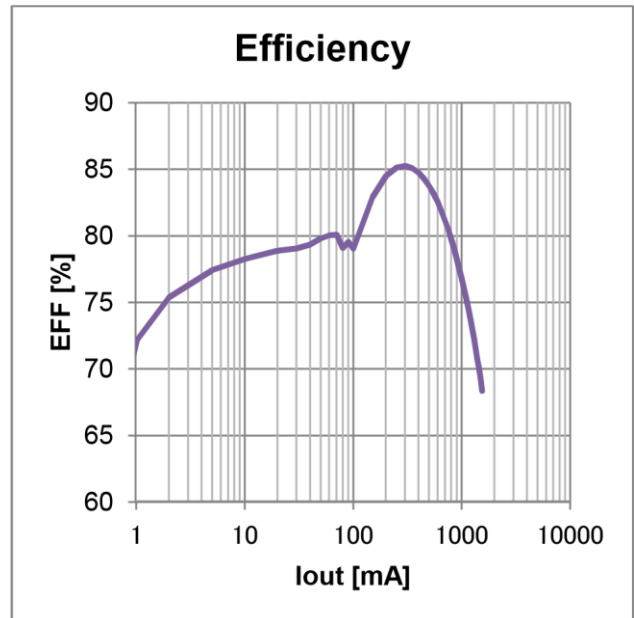
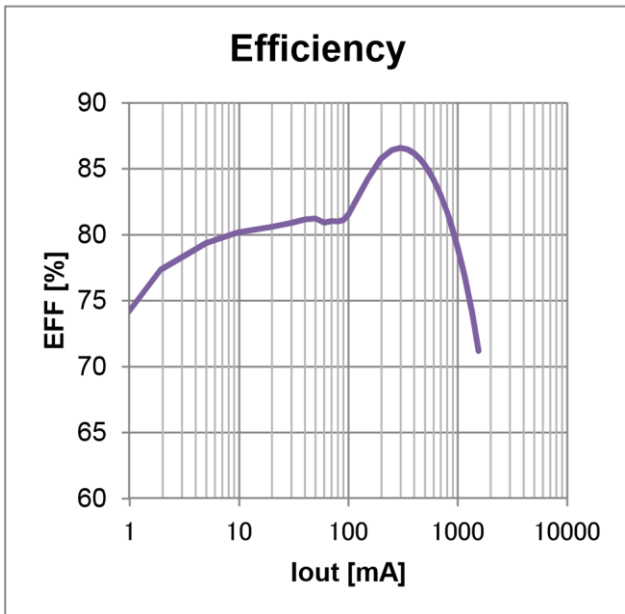

Typical Measurement Data (reference purpose only)

(Ta=25°C)

Load Regulation

• Vin=5.0V, Vout=3.3V

• Vin=3.7V, Vout=1.8V

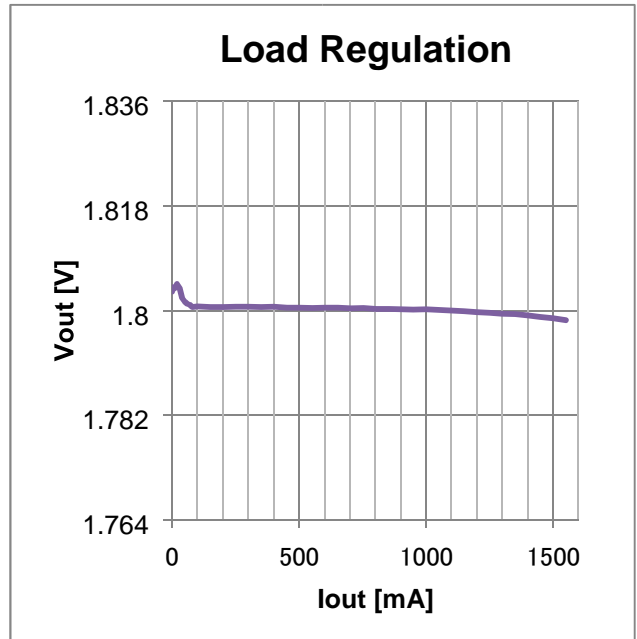
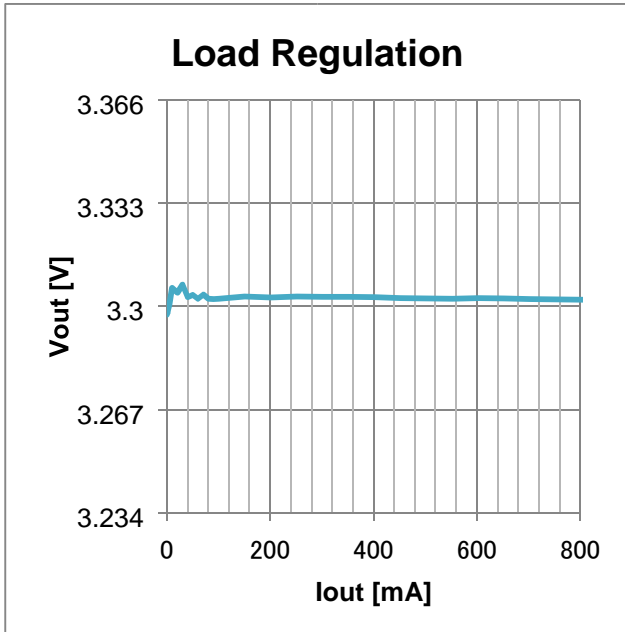

• Vin=3.7V, Vout=1.2V

• Vin=3.7V, Vout=1.0V

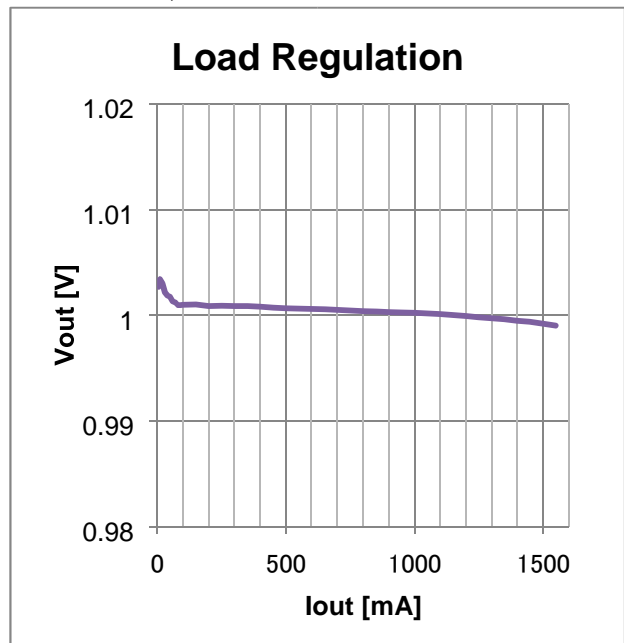
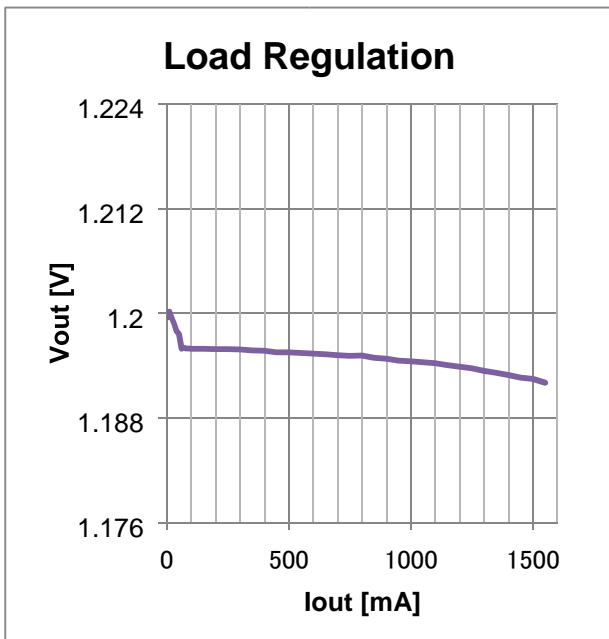

Typical Measurement Data (reference purpose only)

Output Ripple-Noise

• Vin=5.0V, Vout=3.3V, BW : 150MHz

• Vin=3.7V, Vout=1.8V, BW: 150MHz

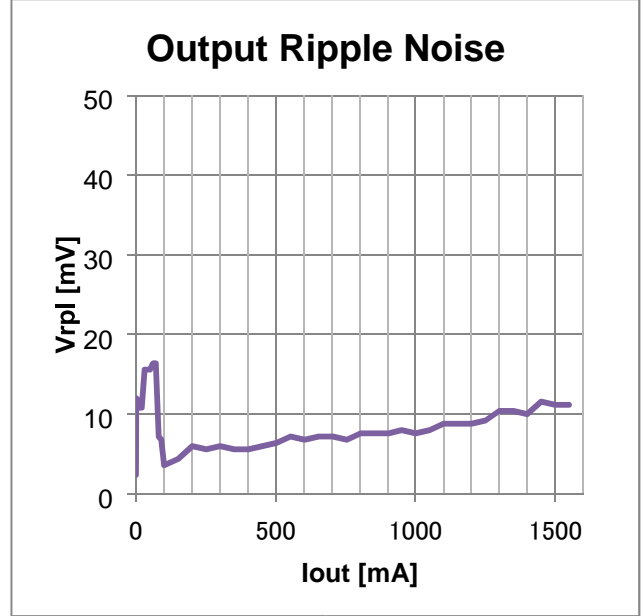
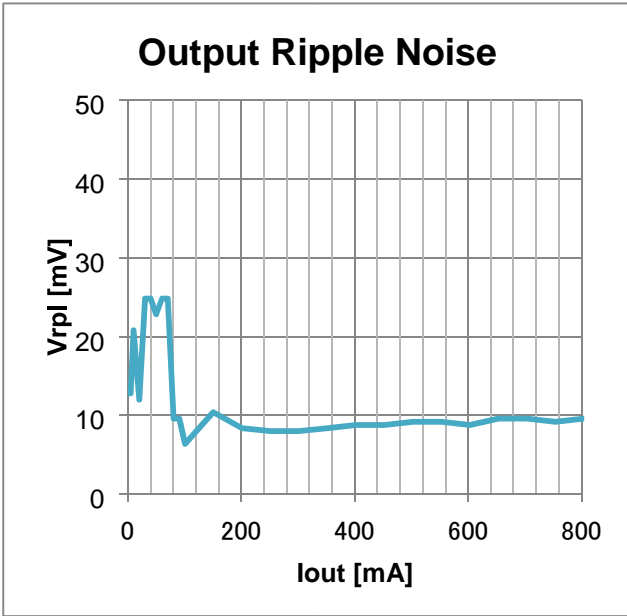

• Vin=3.7V, Vout=1.2V, BW: 150MHz

• Vin=3.7V, Vout=1.0V, BW: 150MHz

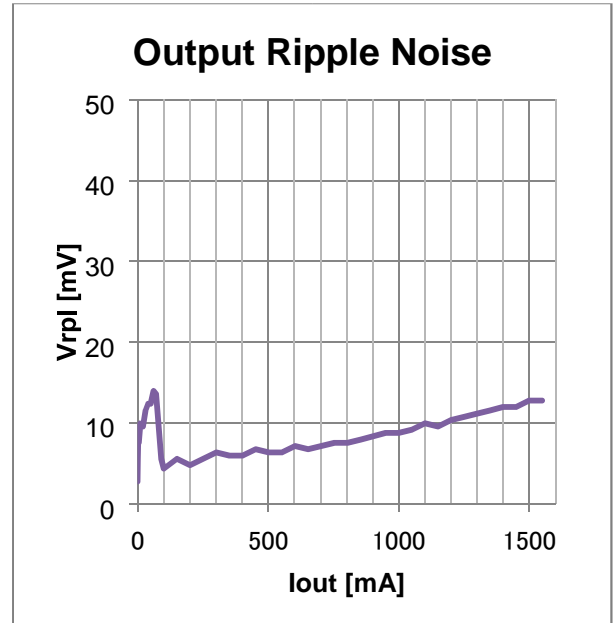
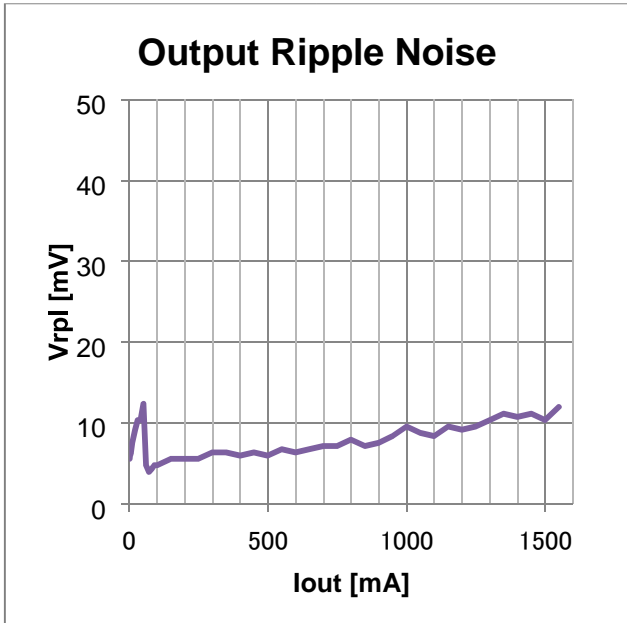

Typical Measurement Data (reference purpose only) (Ta=25°C)

Load Transient Response

• Vin=5.0V, Vout=3.3V

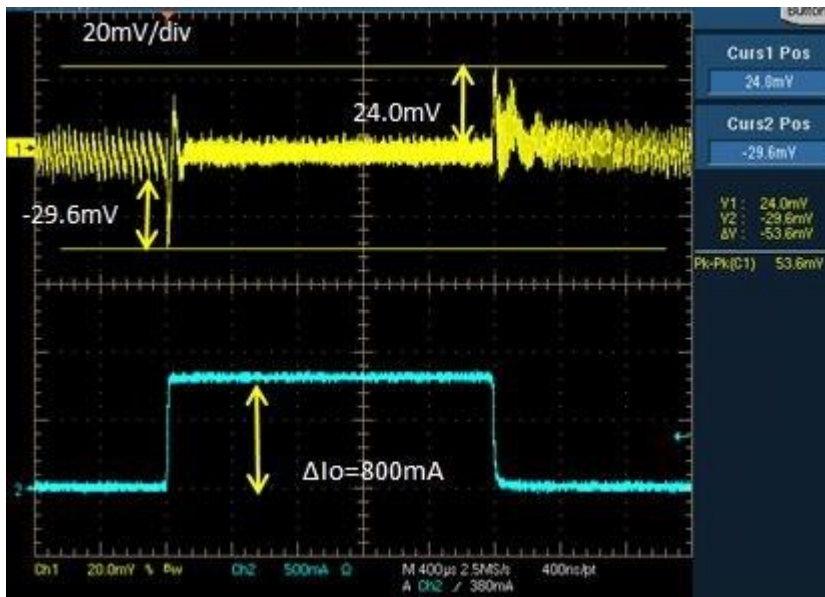

- Vin=3.7V, Vout=1.8V

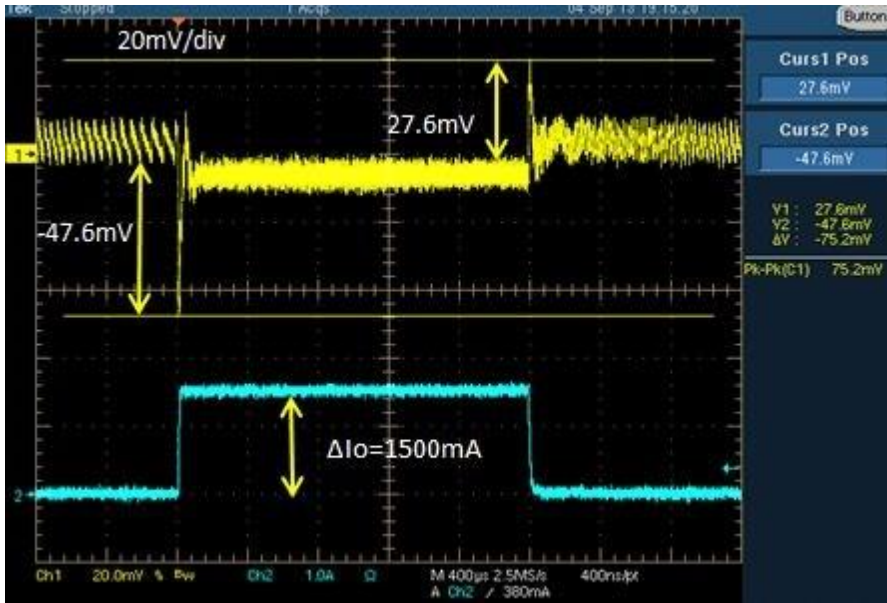

- Vin=3.7V, Vout=1.2V

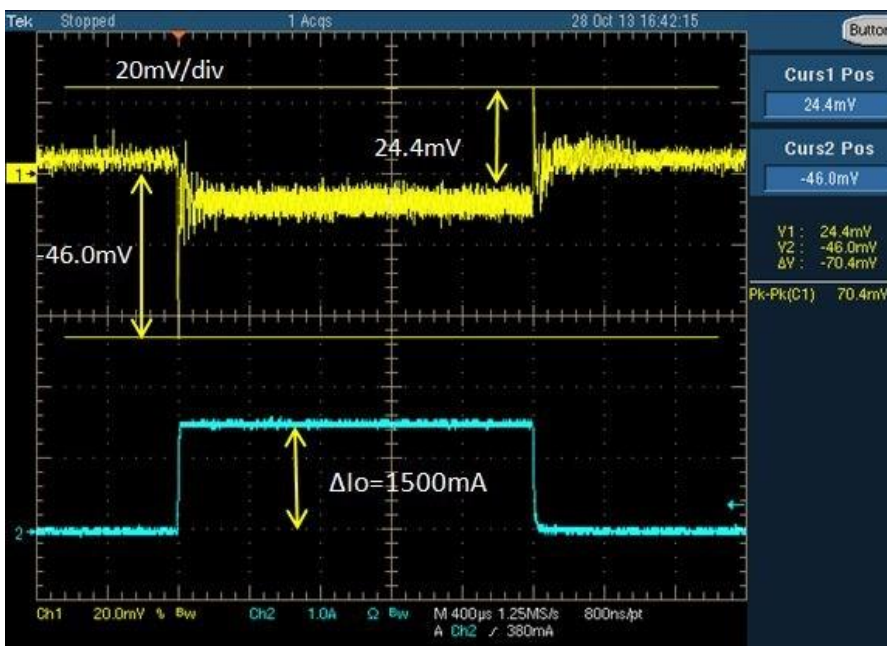

- Vin=3.7V, Vout=1.0V

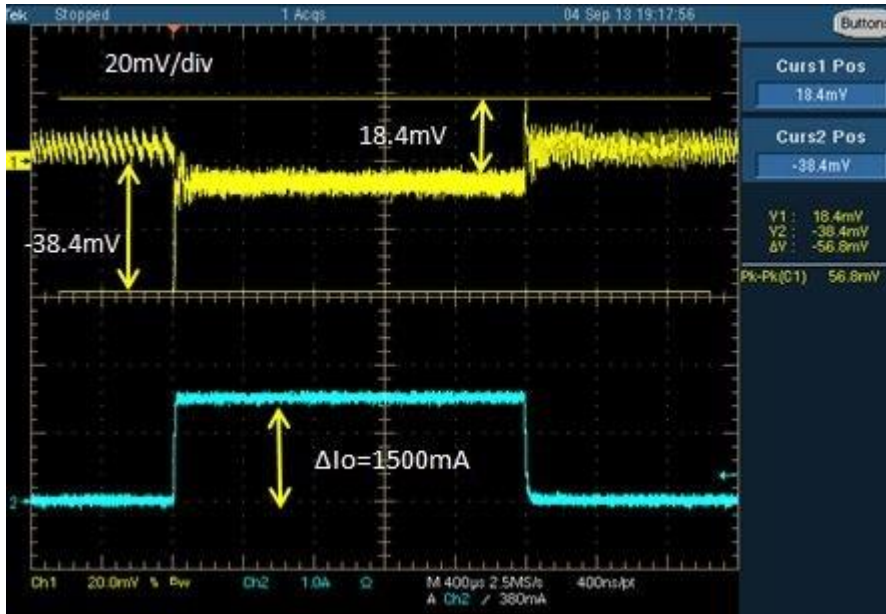

11. Reliability Tests

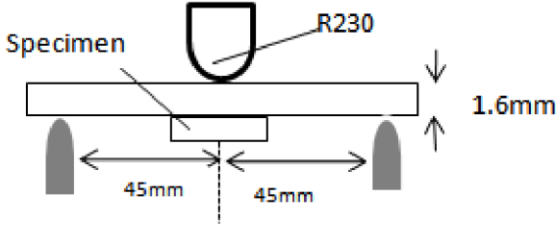
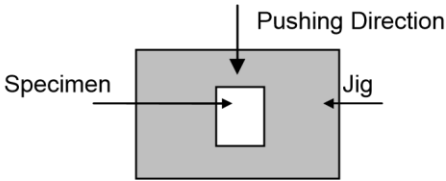
No.	Items	Condition	Number	Result (Fail)
1	Vibration Resistance	Frequency : 10~2000 Hz Acceleration : 196 m/s ² Direction : X,Y,Z 3 axis Period : 2.5h on each	18	G (0)
2	Shock	Acceleration : 980m/s ² Period : 6 ms. Cycle : 6 directions x 3 times	18	G (0)
3	Deflection	Solder specimens on the testing jig (glass epoxy boards) shown in appended below figure. No damage with 1.6mm deflection 	18	G (0)
4	Soldering strength (Push Strength)	Solder specimens onto test jig shown below. Apply pushing force at 10N until electrode pads are peeled off or ceramics are broken. Pushing force is applied in a longitudinal direction. 	18	G (0)
5	Solderability of Termination	75% of the terminations are to be soldered evenly and continuously.	18	G (0)
6	Heat Shock	Temperature: -40°C for 30min , 85°C for 30min Period :30min on each Cycle :100 times	18	G (0)
7	High Temp Exposure	Temperature: 105°C Period :1000h	18	G (0)
8	Low Temp Exposure	Temperature: -40°C Period :1000h	18	G (0)

No	Items	Condition	Number	Result (Fail)
9	Humidity (Steady State)	Temperature: 85°C Humidity: 85%RH Period : 1000h	18	G (0)
10	ESD (Machine Model)	C : 200pF、 R : 0Ω TEST Voltage : +/-200V	18	G (0)
11	ESD (Human Body Model)	C : 100pF、 R : 1500Ω TEST Voltage : +/-2000V	18	G (0)
12	ESD (Charged Machine Model)	Confirming to JEITA4701 300-2 TEST Voltage : +/-500V	18	G (0)

12. Tape and Reel Packing

1) Dimensions of Tape (Paper tape)

(Unit : mm)

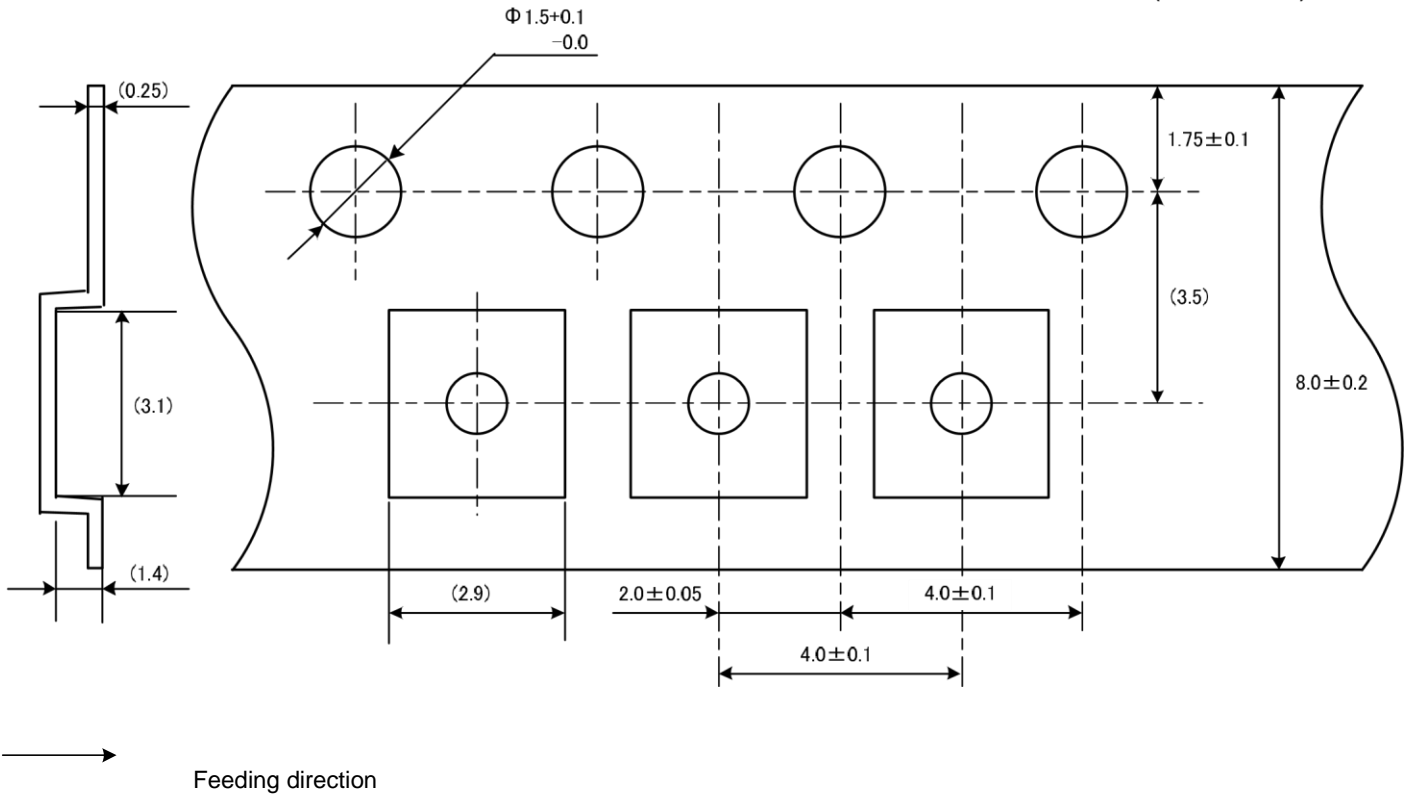

2) Dimensions of Reel

(Unit : mm)

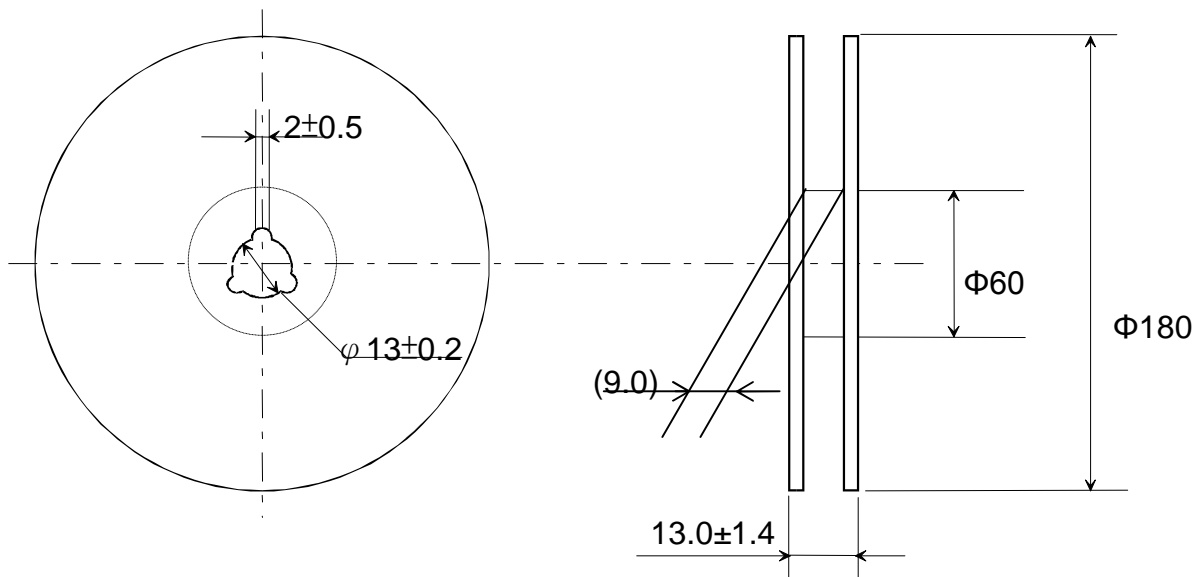

3) Taping Diagrams

[1] Feeding Hole : As specified in (1)

[2] Hole for chip : As specified in (1)

[3] Cover tape : 50um in thickness

[4] Base tape : As specified in (1)

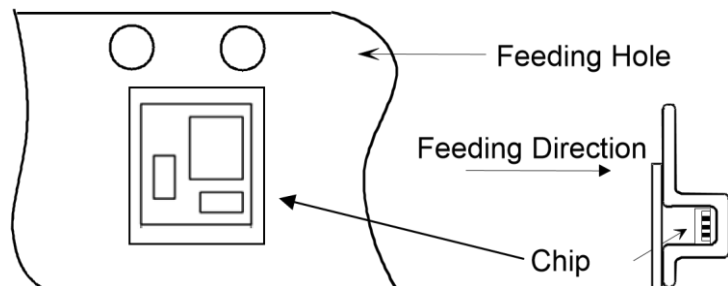
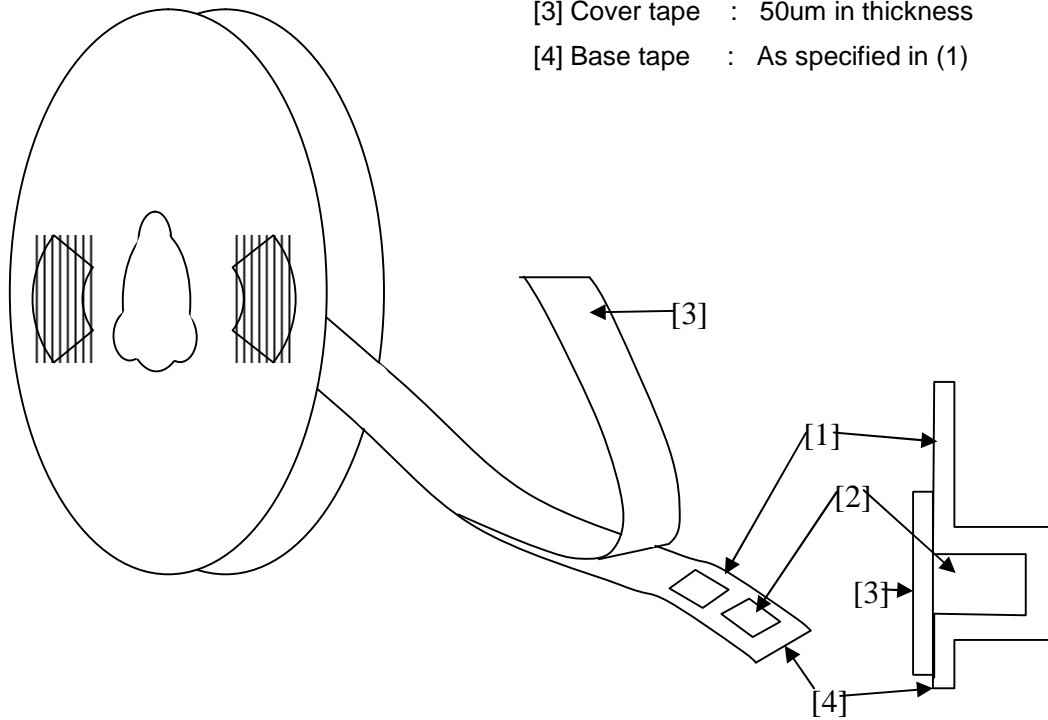

4) Leader and Tail tape

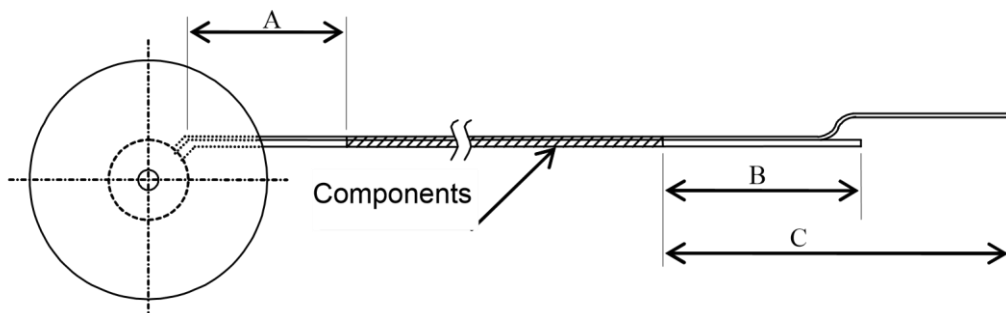

Symbol	Items	Ratings(mm)
A	No components at trailer	min 160
B	No components at leader	min 100
C	Whole leader	min 400

- 5) The tape for chips are wound clockwise and the feeding holes are to the right side as the tape is pulled toward the user.
- 6) Packaging unit: 3,000 pcs./ reel
- 7) Material : Base Tape ... Plastic
 Reel ... Plastic
 Antistatic coating for both base tape and reel
- 8) Peeling of force

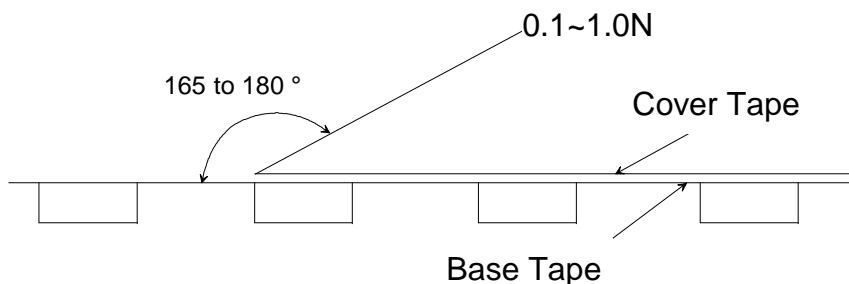

NOTICE

1. Storage Conditions:

To avoid damaging the solderability of the external electrodes, be sure to observe the following points.

- Store products where the ambient temperature is 15 to 35 °C and humidity 45 to 75% RH.
 (Packing materials, In particular, may be deformed at the temperature over 40 °C.).
- Store products in non corrosive gas (Cl₂, NH₃, SO₂, NO_x, etc.).
- Stored products should be used within 6 months of receipt. Solderability should be verified if this period is exceeded

This product is applicable to MSL1 (Based on IPC/JEDEC J-STD-020).

2. Handling Conditions:

Be careful in handling or transporting the product. Excessive stress or mechanical shock may damage the product because of the nature of ceramics structure.
 Do not touch the product, especially the terminals, with bare hands. Doing so may result in poor solderability.

3. Standard PCB Design (Land Pattern and Dimensions):

All the ground terminals should be connected to ground patterns. Furthermore, the ground pattern should be provided between IN and OUT terminals. Please refer to the specifications for the standard land dimensions.

The recommended land pattern and dimensions are shown for a reference purpose only. Electrical, mechanical and thermal characteristics of the product shall depend on the pattern design and material / thickness of the PCB. Therefore, be sure to check the product performance in the actual set. When using underfill materials, be sure to check the mechanical characteristics in the actual set.

4. Soldering Conditions:

Soldering is allowed up through 2 times.

Carefully preheat the product : T less than 130 °C.

If the product is cooled down rapidly like being immersed in liquid, it might be damaged by a rapid temperature change. Excessive thermal shock should be avoided.

Soldering should be carried out in the conditions shown below to prevent damaging the product. Contact a Murata representative in case there is concerning about soldering conditions.

Reflow soldering standard conditions (example)

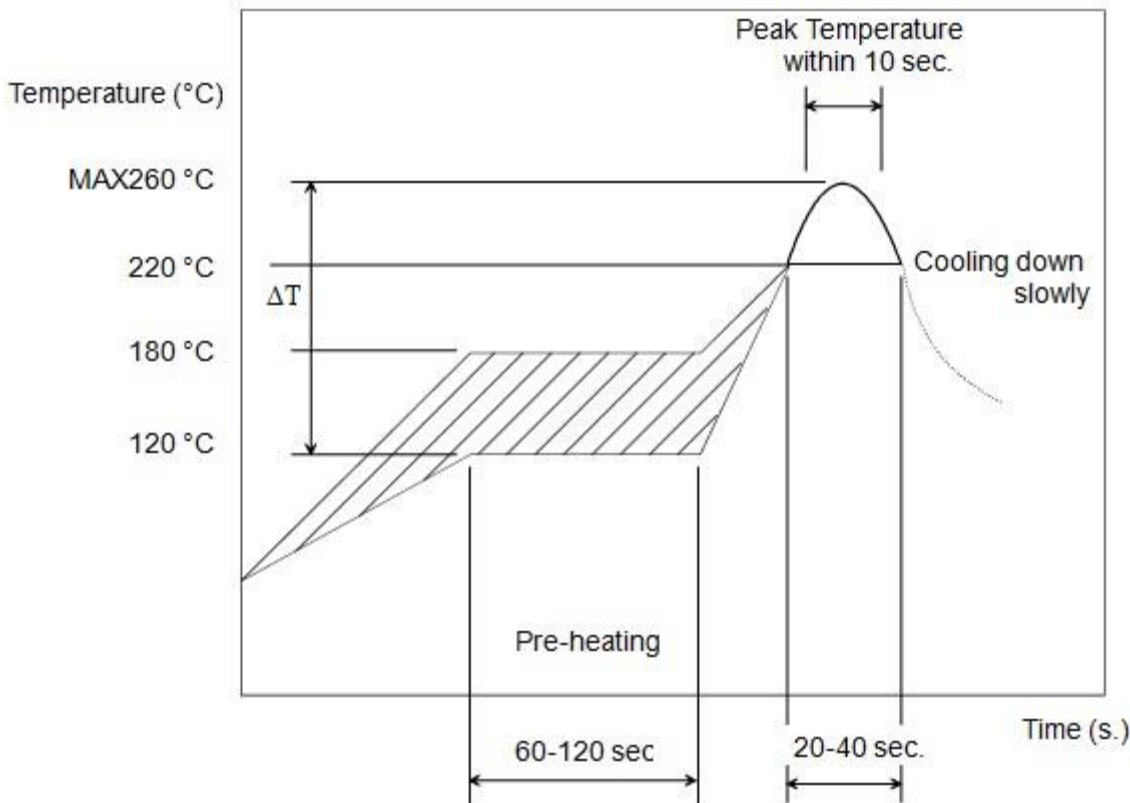

Use rosin type flux or weakly active flux with a chlorine content of 0.2 wt % or less.

5. Cleaning Conditions:

The product is not designed to be cleaned after soldering.

6. Operational Environment Conditions:

Products are designed to work for electronic products under normal environmental conditions (ambient temperature, humidity and pressure). Therefore, products have no problems to be used under the similar conditions to the above-mentioned. However, if products are used under the following circumstances, it may damage products and leakage of electricity and abnormal temperature may occur.

- In an atmosphere containing corrosive gas (Cl₂, NH₃, SO_x, NO_x etc.).
- In an atmosphere containing combustible and volatile gases.
- In a dusty environment. - Direct sunlight
- Water splashing place.
- Humid place where water condenses.
- In a freezing environment.

If there are possibilities for products to be used under the preceding clause, consult with Murata before actual use.

If static electricity is added to this product, degradation and destruction may be produced.

Please use it after consideration enough so that neither static electricity nor excess voltage is added at the time of an assembly and measurement.

If product malfunctions may result in serious damage, including that to human life, sufficient fail-safe measures must be taken, including the following:

- (1) Installation of protection circuits or other protective device to improve system safety
- (2) Installation of redundant circuits in the case of single-circuit failure

7. Input Power Capacity:

Products shall be used in the input power capacity as specified in this specifications.

Inform Murata beforehand, in case that the components are used beyond such input power capacity range.

8. Limitation of Applications:

The products are designed and produced for application in ordinary electronic equipment (AV equipment, OA equipment, telecommunication, etc). If the products are to be used in devices requiring extremely high reliability following the application listed below, you should consult with the Murata staff in advance.

- Aircraft equipment. - Aerospace equipment - Undersea equipment.
- Power plant control equipment.
- Medical equipment.
- Transportation equipment (vehicles, trains, ships, etc.).
- Traffic signal equipment.
- Disaster prevention / crime prevention equipment.
- Data-procession equipment.
- Application which malfunction or operational error may endanger human life and property of assets.
- Application which related to occurrence the serious damage
- Application of similar complexity and/ or reliability requirements to the applications listed in the above.



Note:

Please make sure that your product has been evaluated and confirmed against your specifications when our product is mounted to your product.

Product specifications are subject to change or our products in it may be discontinued without advance notice.

This catalog is for reference only and not an official product specification document, therefore, please review and approve our official product specification before ordering this product.