

DESCRIPTION

The MP2112 is a 1MHz constant frequency, current mode, PWM step-down converter. The device integrates a main switch and a synchronous rectifier for high efficiency without an external Schottky diode. It is ideal for powering portable equipment that powered by a single cell Lithium-Ion (Li+) battery. The MP2112 can supply 1A of load current from a 2.5V to 6V input voltage. The output voltage can be regulated as low as 0.6V. The MP2112 can also run at 100% duty cycle for low dropout applications.

The MP2112 is available in space-saving 6-pin QFN and TSOT23-5 packages.

FEATURES

- High Efficiency: Up to 95%
- 1MHz Constant Switching Frequency
- 1A Available Load Current
- 2.5V to 6V Input Voltage Range
- Output Voltage as Low as 0.6V
- 100% Duty Cycle in Dropout
- Current Mode Control
- Short Circuit Protection
- Thermal Fault Protection
- <math><0.1\mu\text{A}</math> Shutdown Current
- Space Saving 3mm x 3mm QFN6 and TSOT23-5 Packages

APPLICATIONS

- Cellular and Smart Phones
- Microprocessors and DSP Core Supplies
- PDAs
- MP3 Players
- Digital Still and Video Cameras
- Portable Instruments

All MPS parts are lead-free and adhere to the RoHS directive. For MPS green status, please visit MPS website under Products, Quality Assurance page.

"MPS" and "The Future of Analog IC Technology" are registered trademarks of Monolithic Power Systems, Inc.

TYPICAL APPLICATION

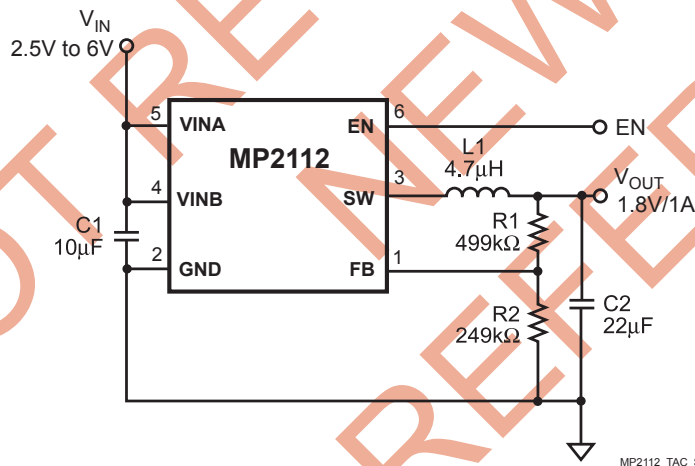

Efficiency vs Load Current

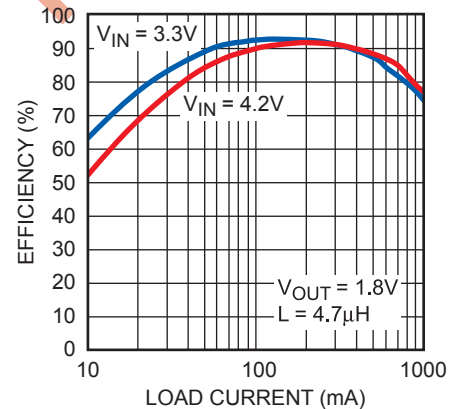

ORDERING INFORMATION

Part Number*	Package	Top Marking	Free Air Temperature (T _A)
MP2112DQ	QFN6 (3mm x 3mm)	G9	-40°C to +85°C
MP2112DJ	TSOT23-5	G9	

* For Tape & Reel, add suffix -Z (e.g. MP2112DQ-Z);
 For RoHS Compliant Packaging, add suffix -LF (e.g. MP2112DQ-LF-Z)

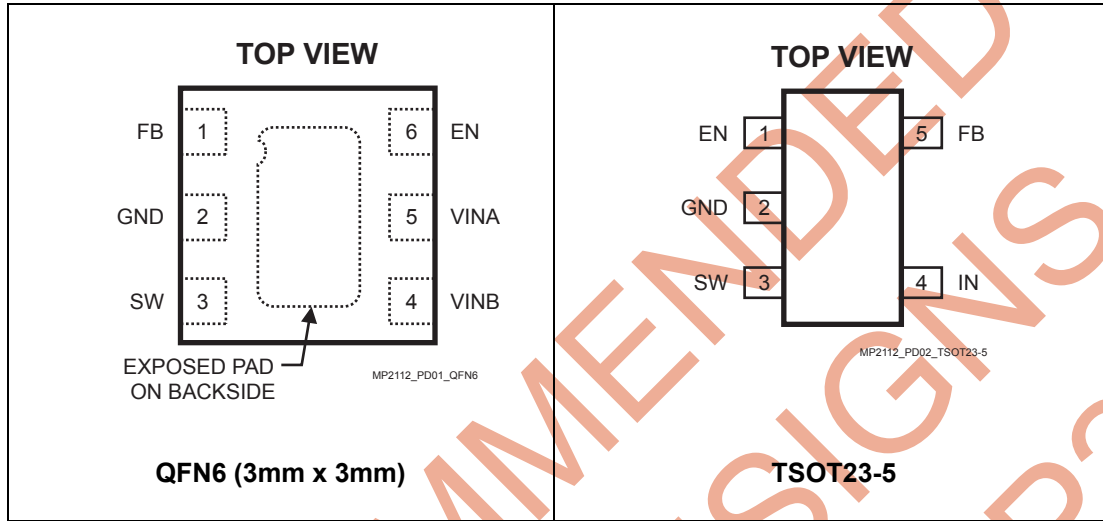
PACKAGE REFERENCE

ABSOLUTE MAXIMUM RATINGS ⁽¹⁾

V _{IN} to GND	-0.3V to +6.5V
V _{SW} to GND	-0.3V to V _{IN} + 0.3V
V _{FB} , V _{EN} to GND	-0.3V to +6.5V
Continuous Power Dissipation (T _A = +25°C) ⁽²⁾	
QFN6 (3x3)	2.5W
TSOT23-5	0.57W
Junction Temperature	+150°C
Lead Temperature	+260°C
Storage Temperature	-65°C to +150°C

Recommended Operating Conditions ⁽³⁾

Supply Voltage V _{IN}	2.5V to 6V
Output Voltage V _{OUT}	0.6V to 6V
Operating Junct. Temp (T _J)	-40°C to +125°C

Thermal Resistance ⁽⁴⁾

	θ_{JA}	θ_{JC}
QFN6 (3x3)	50	12... °C/W
TSOT23-5	220	110... °C/W

Notes:

- Exceeding these ratings may damage the device.
- The maximum allowable power dissipation is a function of the maximum junction temperature T_J(MAX), the junction-to-ambient thermal resistance θ_{JA} , and the ambient temperature T_A. The maximum allowable continuous power dissipation at any ambient temperature is calculated by P_D(MAX)=(T_J(MAX)-T_A)/ θ_{JA} . Exceeding the maximum allowable power dissipation will cause excessive die temperature, and the regulator will go into thermal shutdown. Internal thermal shutdown circuitry protects the device from permanent damage.
- The device is not guaranteed to function outside of its operating conditions.
- Measured on JESD51-7, 4-layer PCB.

ELECTRICAL CHARACTERISTICS ⁽⁵⁾
 $V_{IN} = V_{EN} = 3.6V$, $T_A = +25^{\circ}C$, unless otherwise noted.

Parameter	Symbol	Condition	Min	Typ	Max	Units
Supply Current		$V_{EN} = V_{IN}$, $V_{FB} = 0.65V$		440	600	μA
Shutdown Current		$V_{EN} = 0V$, $V_{IN} = 6V$		0.10	1	μA
IN Undervoltage Lockout Threshold		Rising Edge	2.15	2.30	2.40	V
IN Undervoltage Lockout Hysteresis				55		mV
Regulated FB Voltage	V_{FB}	$T_A = +25^{\circ}C$	0.591	0.600	0.609	V
		$-40^{\circ}C \leq T_A \leq +85^{\circ}C$	0.588	0.600	0.612	
FB Input Bias Current		$V_{FB} = 0.65V$	-50	0.5	+50	nA
PFET On Resistance		$I_{SW} = 100mA$		0.42		Ω
NFET On Resistance		$I_{SW} = -100mA$		0.26		Ω
SW Leakage Current		$V_{EN} = 0V$, $V_{IN} = 6V$, $V_{SW} = 0V$ or $6V$	-1		+1	μA
PFET Current Limit		Duty Cycle = 100%, Current Pulse Width < 1ms	1.2	1.9		A
Oscillator Frequency	f_{OSC}		0.85	1.05	1.3	MHz
Thermal Shutdown Trip Threshold				145		$^{\circ}C$
EN Trip Threshold		$-40^{\circ}C \leq T_A \leq +85^{\circ}C$	0.3	0.96	1.5	V
EN Input Current		$V_{IN} = 0V$ to $6V$	-1		1	μA

Note:

 5) 100% production test at $+25^{\circ}C$. Specifications over the temperature range are guaranteed by design and characterization.

PIN FUNCTIONS

Pin #		Name	Description
QFN6	TSOT23-5		
1	5	FB	Feedback Input. Connect FB to the center point of the external resistor divider. The feedback threshold voltage is 0.6V.
2	2	GND	Ground.
3	3	SW	Power Switch Output. Inductor connection to drains of the internal PFET and NFET switches.
4	-	VINB	Supply Input-Power.
5	-	VINA	Supply Input-Analog.
6	1	EN	Enable Input.

TYPICAL PERFORMANCE CHARACTERISTICS

$V_{IN} = 3.3V$, $V_{OUT} = 1.8V$, $L1 = 4.7\mu H$, $C1 = 4.7\mu F$, $C3 = 10\mu F$, $T_A = +25^\circ C$, unless otherwise noted.

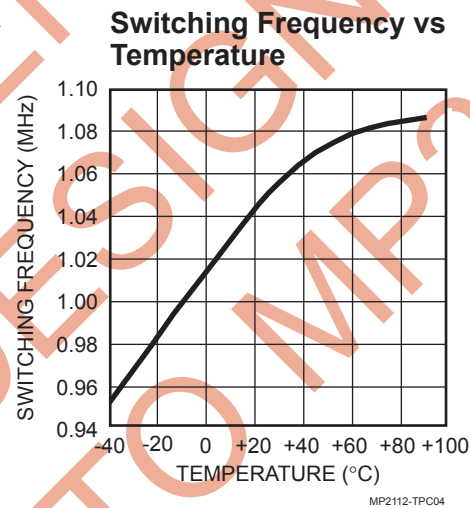
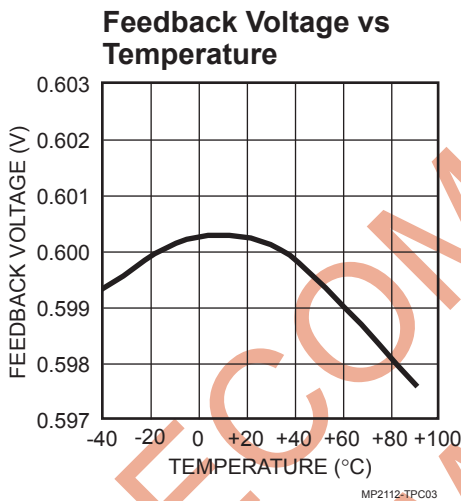
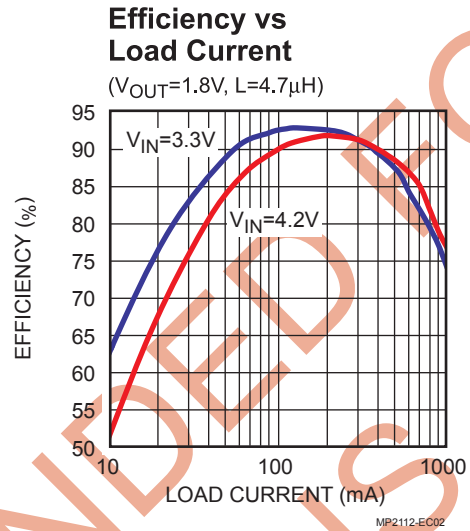
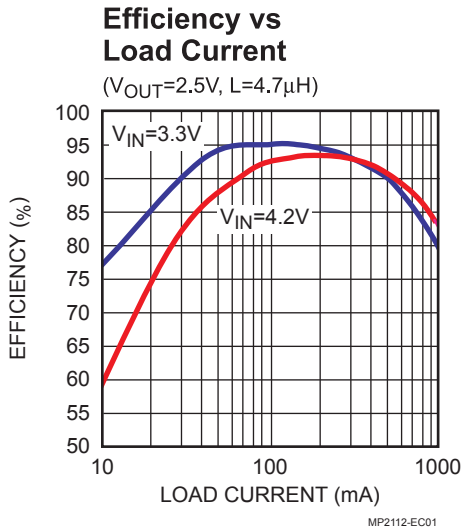

TYPICAL PERFORMANCE CHARACTERISTICS *(continued)*

$V_{IN} = 3.3V$, $V_{OUT} = 1.8V$, $L1 = 4.7\mu H$, $C1 = 4.7\mu F$, $C3 = 10\mu F$, $T_A = +25^\circ C$, unless otherwise noted.

Load Transient

($I_{OUT}=0mA$ to $500mA$ step)

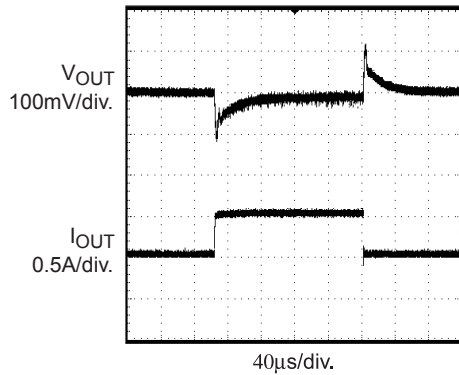

MP2112-TPC05

No Load Operation

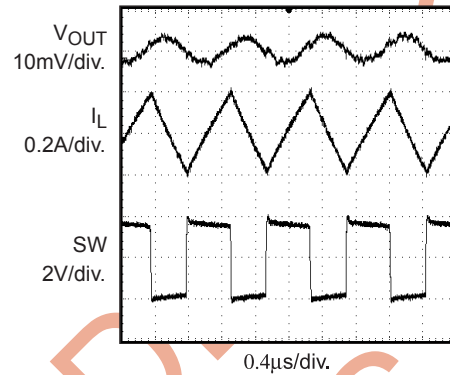

MP2112-TPC06

Heavy Load Operation

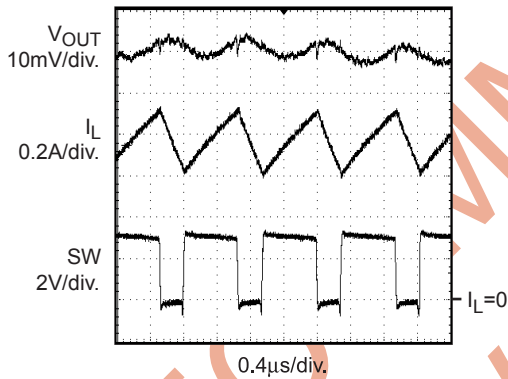

MP2112-TPC07

Startup from Shutdown

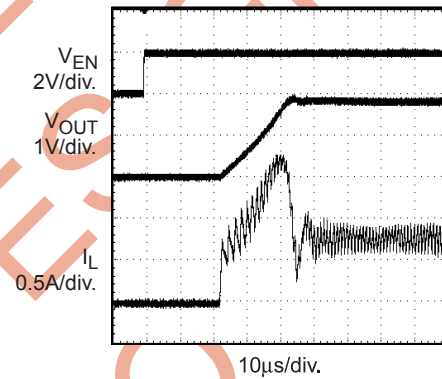

MP2112-TPC08

Short Circuit Protection (No Load)

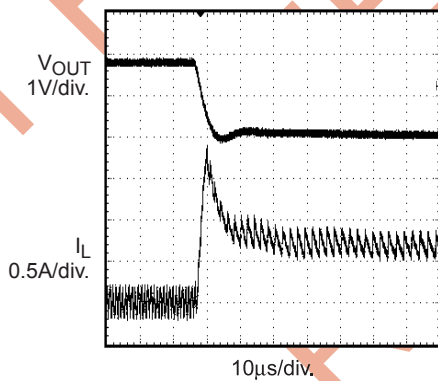

MP2112-TPC09

Short Circuit Recovery (No Load)

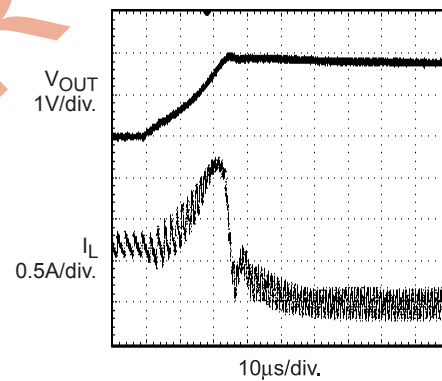

MP2112-TPC10

Current Mode PWM Control

Slope compensated current mode PWM control provides stable switching and cycle-by-cycle current limit for superior load and line response. This protects the internal main switch and synchronous rectifier. The MP2112 switches at a constant frequency (1MHz) and regulates the output voltage. During each cycle the PWM comparator modulates the power transferred to the load by changing the inductor peak current based on the feedback error voltage. During normal operation, the main switch is turned on for a certain time to ramp the inductor current at each rising edge of the internal oscillator, then switched off when the peak inductor current rises above the error voltage. When the main switch is off, the synchronous rectifier will turn on immediately and stay on until the next cycle starts.

Dropout Operation

The MP2112 allows the main switch to remain on for more than one switching cycle and increases the duty cycle while the input voltage is dropping close to the output voltage. When the duty cycle reaches 100%, the main switch continuously delivers current to the output up to the PFET

current limit. The output voltage is the input voltage minus the voltage drop across the main switch and the inductor.

Short Circuit Protection

The MP2112 has short circuit protection. When the output is shorted to ground, the oscillator frequency is reduced to prevent the inductor current from increasing beyond the PFET current limit. The PFET current limit is also reduced to lower the short circuit current. The frequency and current limit will return to the normal values once the short circuit condition is removed and the feedback voltage reaches 0.6V.

Maximum Load Current

The MP2112 can operate down to a 2.5V input voltage; however the maximum load current decreases at lower input due to a large IR drop on the main switch and synchronous rectifier. The slope compensation signal reduces the peak inductor current as a function of the duty cycle to prevent sub-harmonic oscillations at duty cycles greater than 50%. Conversely the current limit increases as the duty cycle decreases.

APPLICATION INFORMATION

Output Voltage Setting

The external resistor divider sets the output voltage (see Typical Application Circuit on page 1). The feedback resistor (R1) also sets the feedback loop bandwidth with the internal compensation capacitor (see Typical Application Circuit).

Choose R1 around 500kΩ for optimal transient response. R2 is then given by:

$$R2 = \frac{R1}{\frac{V_{OUT}}{0.6V} - 1}$$

Table 1—Resistor Selection vs. Output Voltage Setting

V _{OUT}	R1	R2
1.2V	499kΩ (1%)	499kΩ (1%)
1.5V	499kΩ (1%)	332kΩ (1%)
1.8V	499kΩ (1%)	249kΩ (1%)
2.5V	499kΩ (1%)	158kΩ (1%)

Inductor Selection

A 1μH to 10μH inductor with DC current rating at least 25% higher than the maximum load current is recommended for most applications. For best efficiency, the inductor DC resistance shall be <200mΩ. See Table 2 for recommended inductors and manufacturers. For most designs, the inductance value can be derived from the following equation:

$$L1 = \frac{V_{OUT} \times (V_{IN} - V_{OUT})}{V_{IN} \times \Delta I_L \times f_{OSC}}$$

where ΔI_L is the Inductor Ripple Current. Choose inductor ripple current approximately 30% of the maximum load current, 1A.

The maximum inductor peak current is:

$$I_{L(MAX)} = I_{LOAD} + \frac{\Delta I_L}{2}$$

Under light load conditions below 100mA, larger inductance is recommended for improved efficiency. Table 3 lists inductors recommended for this purpose.

Table 2—Suggested Surface Mount Inductors

Manufacturer	Part Number	Inductance (μH)	Max DCR (Ω)	Saturation Current (A)	Dimensions LxWxH (mm ³)
Coilcraft	D63CB	4.7	0.026	2.0	6.3X6.3X3.5
Toko	D53LC	4.7	0.026	2.0	6.3X6.3X3.5
Sumida	CDC5D23B	4.7	0.062	1.6	6.0X6.0X2.5

Table 3—Inductors for Improved Efficiency at 25mA, 50mA, under 100mA Load.

Manufacturer	Part Number	Inductance (μH)	Max DCR (Ω)	Saturation Current (A)	I _{RMS} (A)
Coilcraft	DO1605T-103MX	10	0.3	1.0	0.9
Murata	LQH4C100K04	10	0.2	1.2	0.8
Sumida	CR32-100	10	0.2	1.0	0.7
Sumida	CR54-100	10	0.1	1.2	1.4

Input Capacitor Selection

The input capacitor (C1) reduces the surge current drawn from the input and switching noise from the device. The input capacitor impedance at the switching frequency must be less than input source impedance to prevent high frequency switching current passing to the input. Ceramic capacitors with X5R or X7R dielectrics are highly recommended because of their low ESR and small temperature coefficients. For most applications, a 4.7µF capacitor is sufficient.

Output Capacitor Selection

The output capacitor (C2) keeps output voltage ripple small and ensures regulation loop stable. The output capacitor impedance should remain low at the switching frequency. Ceramic capacitors with X5R or X7R dielectrics are recommended. The output ripple ΔV_{OUT} is approximately:

$$\Delta V_{OUT} \leq \frac{V_{OUT} \times (V_{IN} - V_{OUT})}{V_{IN} \times f_{OSC} \times L} \times \left(ESR + \frac{1}{8 \times f_{OSC} \times C2} \right)$$

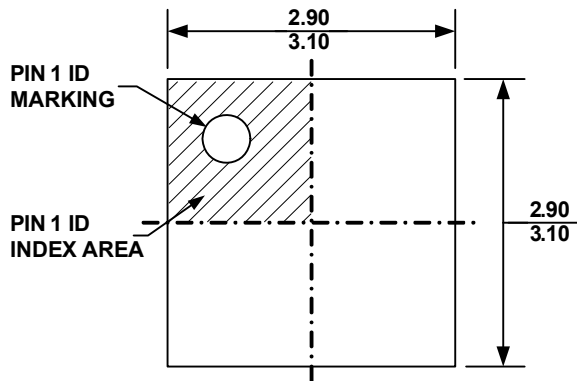
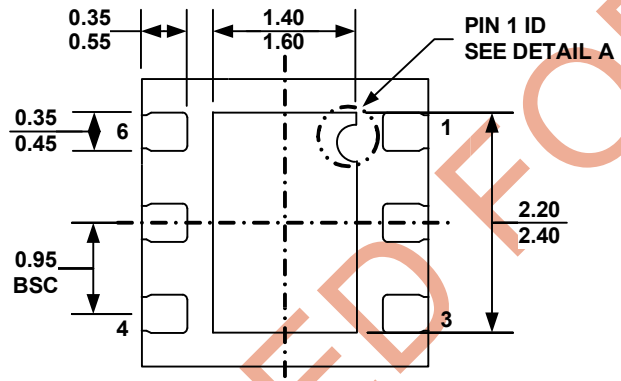
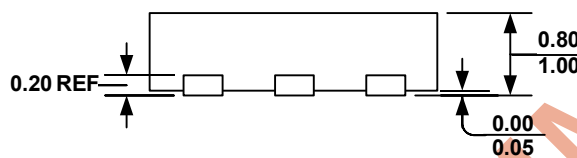
PACKAGE INFORMATION
QFN6 (3mm x 3mm)

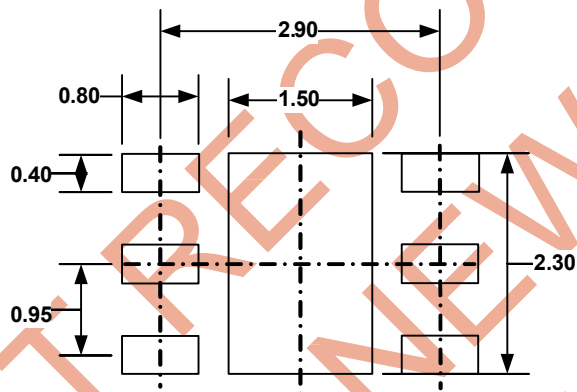
TOP VIEW

BOTTOM VIEW

SIDE VIEW
**PIN 1 ID OPTION A
R0.20 TYP.**
**PIN 1 ID OPTION B
R0.20 TYP.**

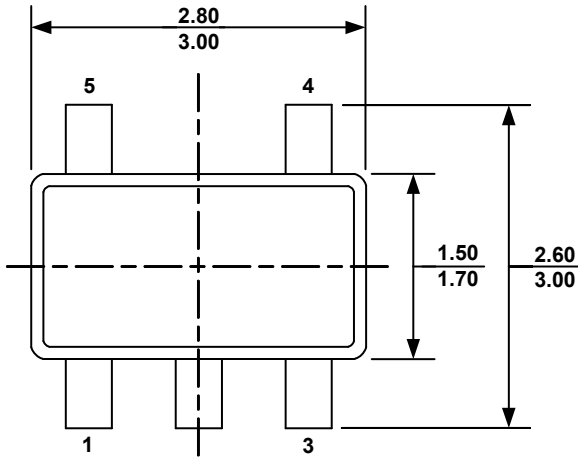
DETAIL A

RECOMMENDED LAND PATTERN
NOTE:

- 1) ALL DIMENSIONS ARE IN MILLIMETERS
- 2) EXPOSED PADDLE SIZE DOES NOT INCLUDE MOLD FLASH
- 3) LEAD COPLANARITY SHALL BE 0.10 MILLIMETER MAX
- 4) JEDEC REFERENCE IS MO-229, VARIATION VEEA-2.
- 5) DRAWING IS NOT TO SCALE

TSOT23-5

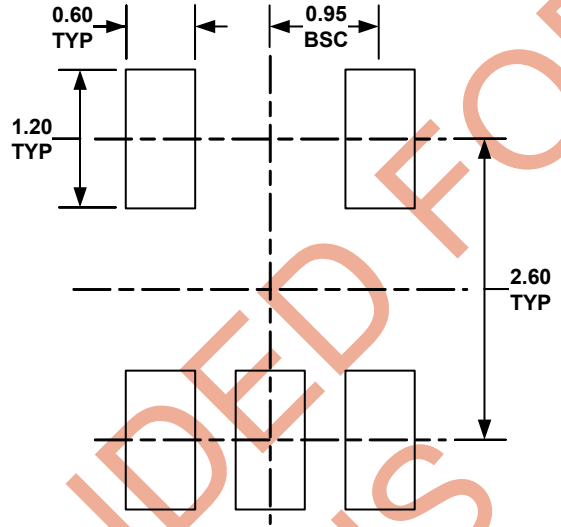

TOP VIEW



RECOMMENDED LAND PATTERN

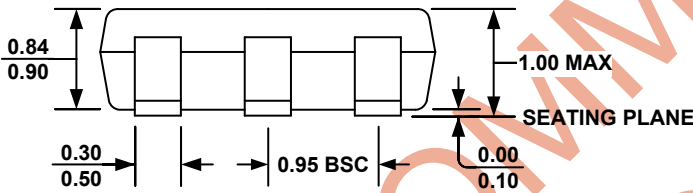

FRONT VIEW

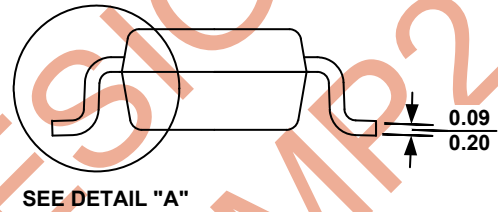

SIDE VIEW

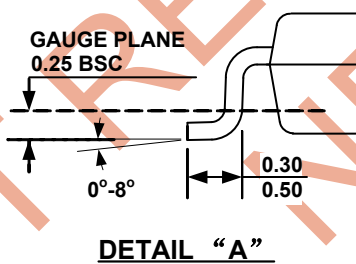

DETAIL "A"

NOTE:

- 1) ALL DIMENSIONS ARE IN MILLIMETERS.
- 2) PACKAGE LENGTH DOES NOT INCLUDE MOLD FLASH, PROTRUSION OR GATE BURR.
- 3) PACKAGE WIDTH DOES NOT INCLUDE INTERLEAD FLASH OR PROTRUSION.
- 4) LEAD COPLANARITY (BOTTOM OF LEADS AFTER FORMING) SHALL BE 0.10 MILLIMETERS MAX.
- 5) DRAWING CONFORMS TO JEDEC MO-193, VARIATION AA.
- 6) DRAWING IS NOT TO SCALE.

NOTICE: The information in this document is subject to change without notice. Please contact MPS for current specifications. Users should warrant and guarantee that third party Intellectual Property rights are not infringed upon when integrating MPS products into any application. MPS will not assume any legal responsibility for any said applications.