

RF1353C

345.00 MHz
SAW Filter

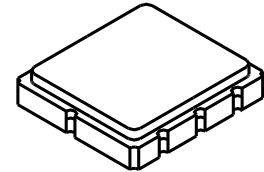

SM5050-8 Case

- *Designed for 345 MHz Wireless Applications*
- *Advanced (Lithium Tantalate) LiTaO3 design for low Insertion Loss*
- *Designed for match to 50 ohms, no external LC required*
- *Hermetically sealed Surface Mount package*
- *Complies with Directive 2002/95/EC (RoHS)*
- *Tape and Reel Standard per ANSI/EIA-481*
- *Moisture Sensitivity Level: 1*

Absolute Maximum Ratings

Rating	Value	Units
Maximum Input Power	+10	dBm
Maximum DC Voltage Between Terminals	30	VDC
Case Temperature	-40 to +85	°C
Solder Reflow Temperature, 5 Cycles Maximum	260° C for 10 seconds	

Characteristic	Sym	Notes	Minimum	Typical	Maximum	Units
Nominal Operating Frequency	f_C			345		MHz
Passband	IL	Insertion Loss			4.5	dB
		3.0 dB Bandwidth	$f_C \pm 70$	$f_C \pm 430$	$f_C \pm 1100$	kHz
Rejection		$f_C - 10.7$ MHz	15			dB
		$f_C - 21.4$ MHz	40			dB
Matching		Untuned response		50		Ω
Ambient Temperature		Operating Range	-10		70	°C
Footprint: 5.0 X 5.0 mm	SM5050-8					
Lid Symbolization (YY=Year, WW=week, S=shift)	446, <u>Y</u> <u>W</u> <u>W</u> <u>S</u>					

Electrical Connections

Connection	Terminals
RF Input	2
RFOutput	6
Case Ground	All Others



CAUTION: Electrostatic Sensitive Device. Observe precautions for handling.

NOTES:

1. The design, manufacturing process, and specifications of this device are subject to change.
2. US or International patents may apply.
3. RoHS compliant from the first date of manufacture.

SM5050-8 Case

8-Terminal Ceramic Surface-Mount Case

5.0 X 5.0 mm Nominal Footprint

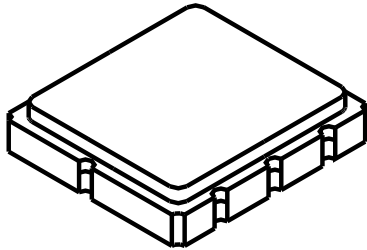

Case Dimensions

Dimension	mm			Inches		
	Min	Nom	Max	Min	Nom	Max
A	4.8	5.0	5.2		0.1968	
B	4.8	5.0	5.2		0.1968	
C			1.7			0.0669
D		2.08			0.0818	
E		1.17			0.046	
F		0.64			0.0252	
G	2.39	2.54	2.69		0.100	

Electrical Connections

Connection		Terminals
Port 1	Differential Input	1, 2
Port 2	Differential Output	5, 6
	Ground	All others
Single-ended Operation		Return is ground
Differential Operation		Return is hot
Dot indicates Pin 1		

TOP VIEW

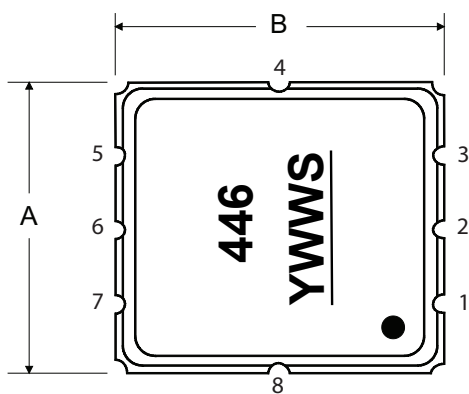

BOTTOM VIEW

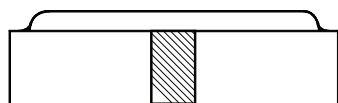
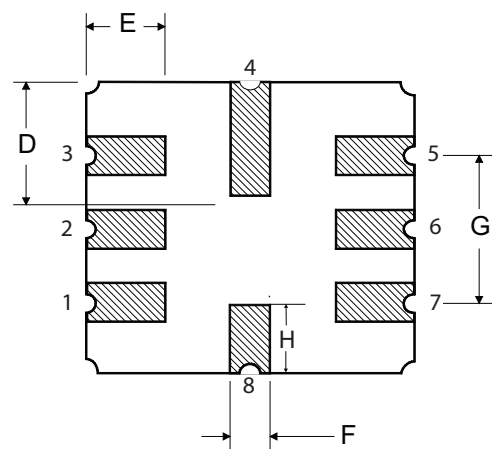

Tape and Reel Specifications

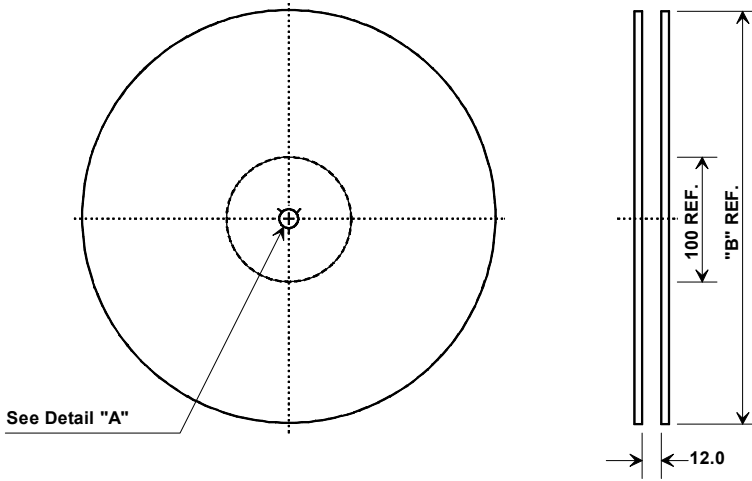

Tape and Reel Standard per ANSI/EIA-481

"B "		Quantity Per Reel
Nominal Size		
Inches	millimeters	
7	178	500
13	330	3000

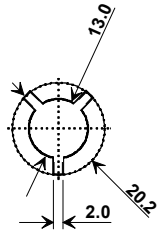

COMPONENT ORIENTATION and DIMENSIONS

Carrier Tape Dimensions	
Ao	5.3 mm
Bo	5.3 mm
Ko	2.0 mm
Pitch	8.0 mm
W	12.0 mm

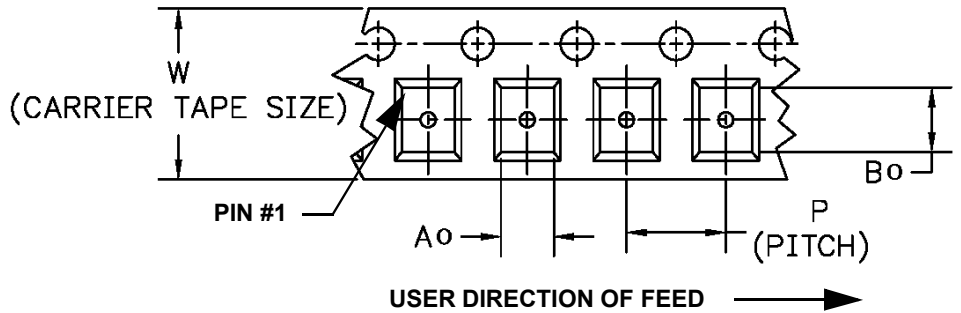
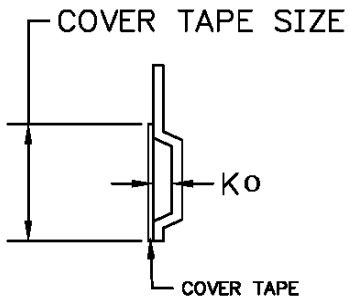

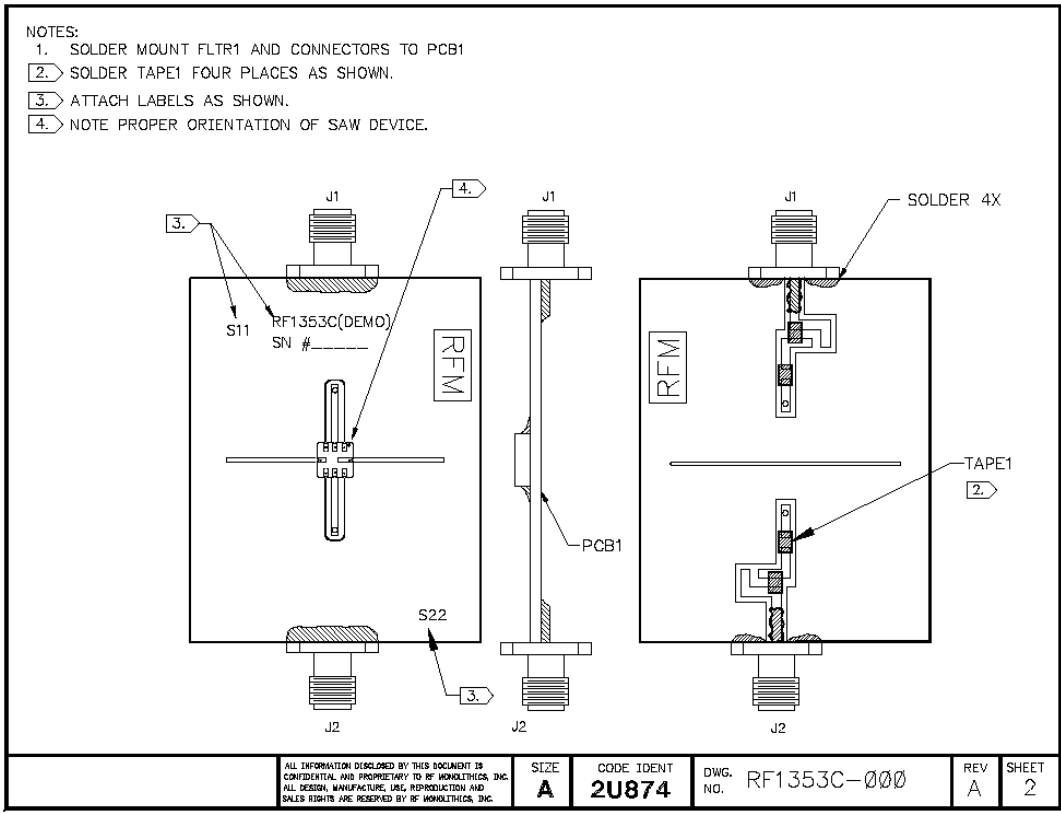
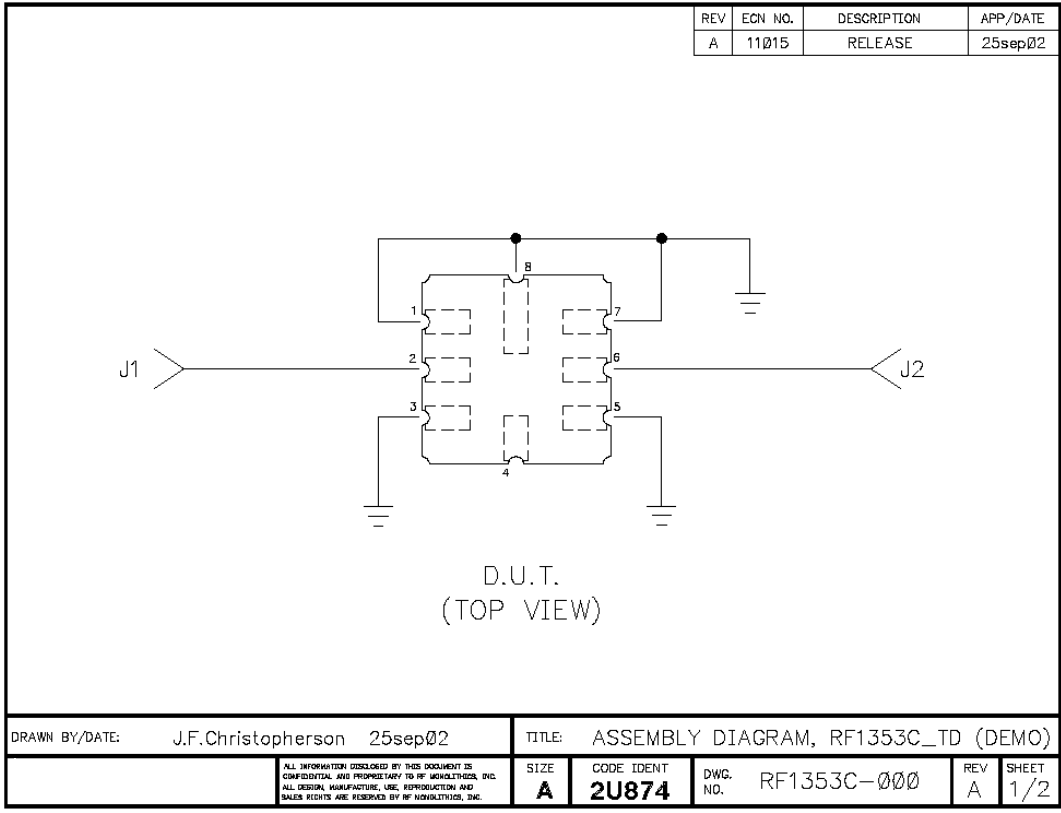

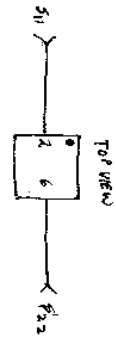
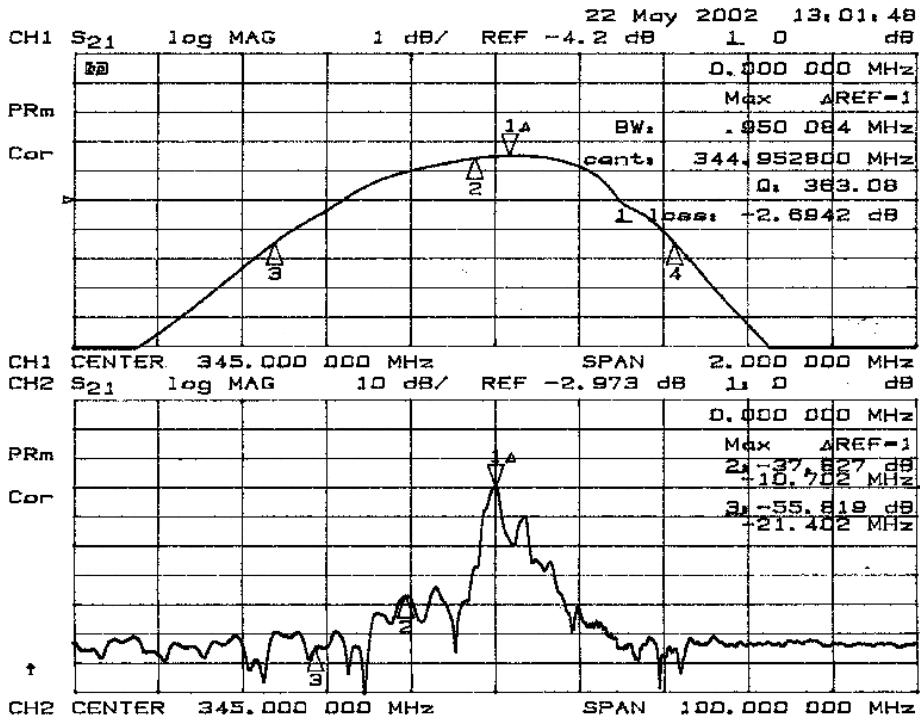

22 May 2002 13:06:59

CH1 S11 1 U FS 1 45.432 n 4.3457 n 2.0048 nH

345.000 000 MHz

PRm

Cor

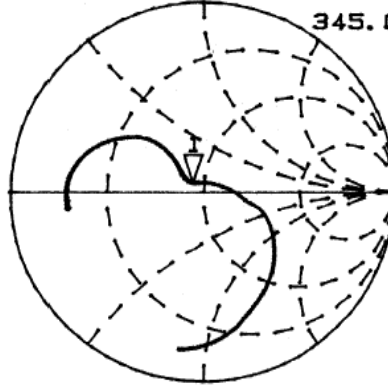

CH2 S22 1 U FS 1 46.686 n 2.0625 n 951.47 pH

345.000 000 MHz

PRm

Cor

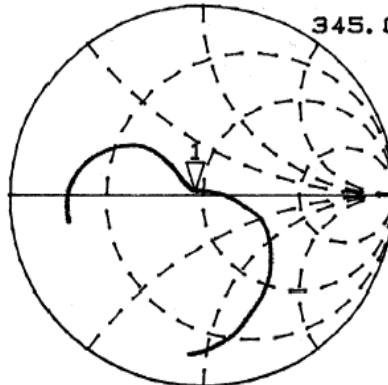

CENTER 345.000 000 MHz SPAN 2.000 000 MHz

Recommended Reflow Profile

1. Preheating shall be fixed at 150~180°C for 60~90 seconds.
2. Ascending time to preheating temperature 150°C shall be 30 seconds min.
3. Heating shall be fixed at 220°C for 50~80 seconds and at 260°C +0/-5°C peak (10 seconds).
4. Time: 5 times maximum.

