

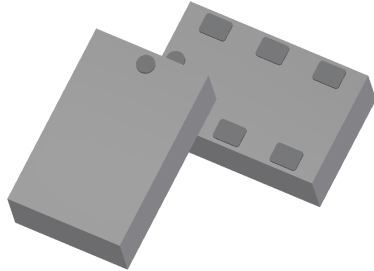

**Ultra Low Profile 0805 Balun**  
**50Ω to 100Ω Balanced**



**Description:**

The BD1631J50100AHF is a low profile sub-miniature balanced to unbalanced transformer designed for differential inputs and output locations on next generation wireless chipsets in an easy to use surface mount package covering 802.11b+g+n, GSM, DCS, PCS and UMTS. The BD1631J50100AHF is ideal for high volume manufacturing and is higher performance than traditional ceramic and lumped element baluns. The BD1631J50100AHF has an unbalanced port impedance of 50Ω and a 100Ω balanced port impedance\*. This transformation enables single ended signals to be applied to differential ports on modern semiconductors. The output ports have equal amplitude (-3dB) with 180 degree phase differential. The BD1631J50100AHF is available on tape and reel for pick and place high volume manufacturing.

**Detailed Electrical Specifications:**

Specifications subject to change without notice.

**Features:**

- 1.6 – 3.1 GHz
- 0.7mm Height Profile
- 50 Ohm to 2 x 50 Ohm
- 802.11 b & g +n Compliant
- Low Insertion Loss
- DCS, PCS & UMTS Compliant
- Input to Output DC Isolation
- Surface Mountable
- Tape & Reel
- Non-conductive Surface
- RoHS Compliant
- Halogen Free

| Parameter             | ROOM (25°C) |      |      |      |      |      | Unit    |
|-----------------------|-------------|------|------|------|------|------|---------|
|                       | Min.        | Typ. | Max  | Min. | Typ. | Max  |         |
| Frequency             | 2.0         |      | 2.5  | 1.6  |      | 3.1  | GHz     |
| Unbalanced Port Imp.  |             | 50   |      |      | 50   |      | Ω       |
| Balanced Port Imp**   |             | 100  |      |      | 100  |      | Ω       |
| Return Loss           | 14          | 17   |      | 10   | 13   |      | dB      |
| Insertion Loss***     |             | 0.6  | 0.8  |      | 0.7  | 1.0  | dB      |
| Amplitude Balance     |             | 0.15 | 0.6  |      | 0.7  | 1.0  | dB      |
| Phase Balance         |             | 2.3  | 4.8  |      | 2.3  | 4.8  | Degrees |
| Power Handling @85°C  |             |      | 0.8  |      |      | 0.8  | Watts   |
| Power Handling @105°C |             |      | 0.5  |      |      | 0.5  | Watts   |
| Operating Temperature | -55         |      | +140 | -55  |      | +140 | °C      |

\*Insertion Loss stated at room temperature (Insertion Loss is approximately 0.1 dB higher at +85 °C)

**Outline Drawing:**

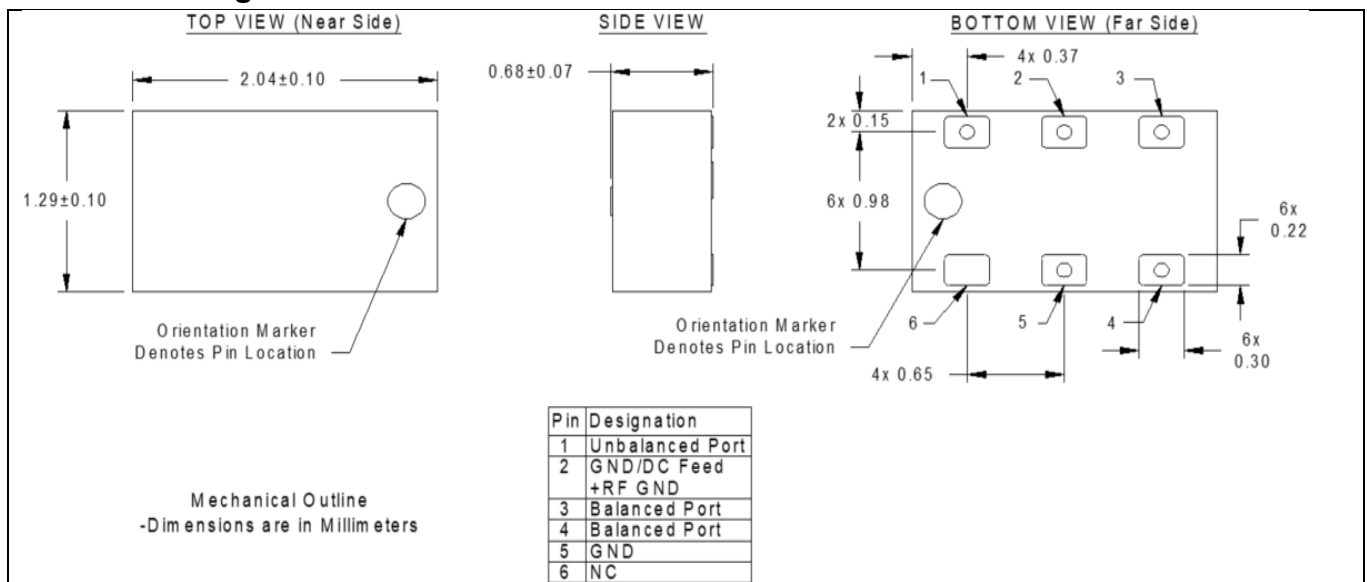

**Typical Performance: 500 MHz to 8500 MHz**

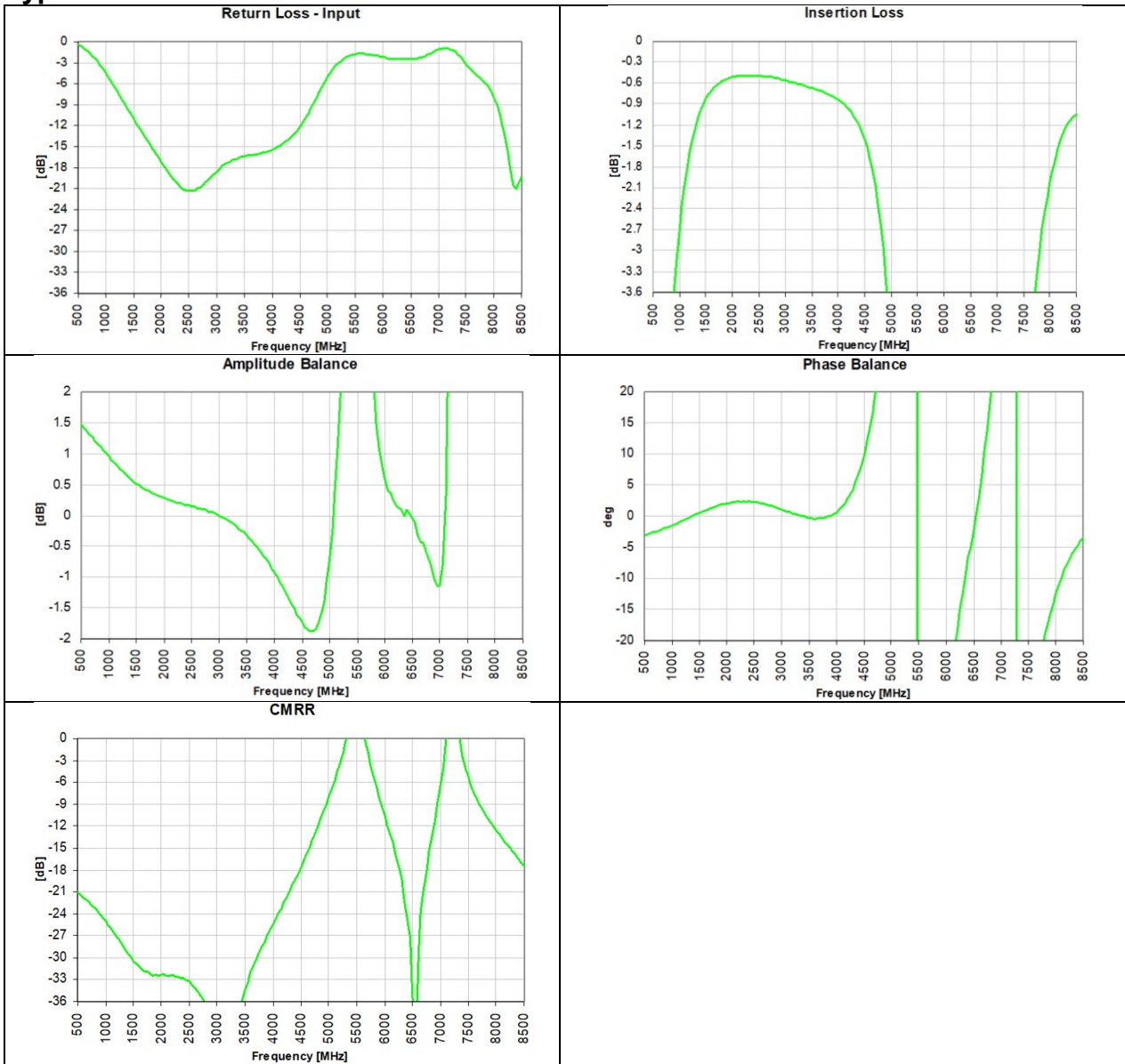

**Wide Band Performance: 1600 MHz to 3100 MHz**

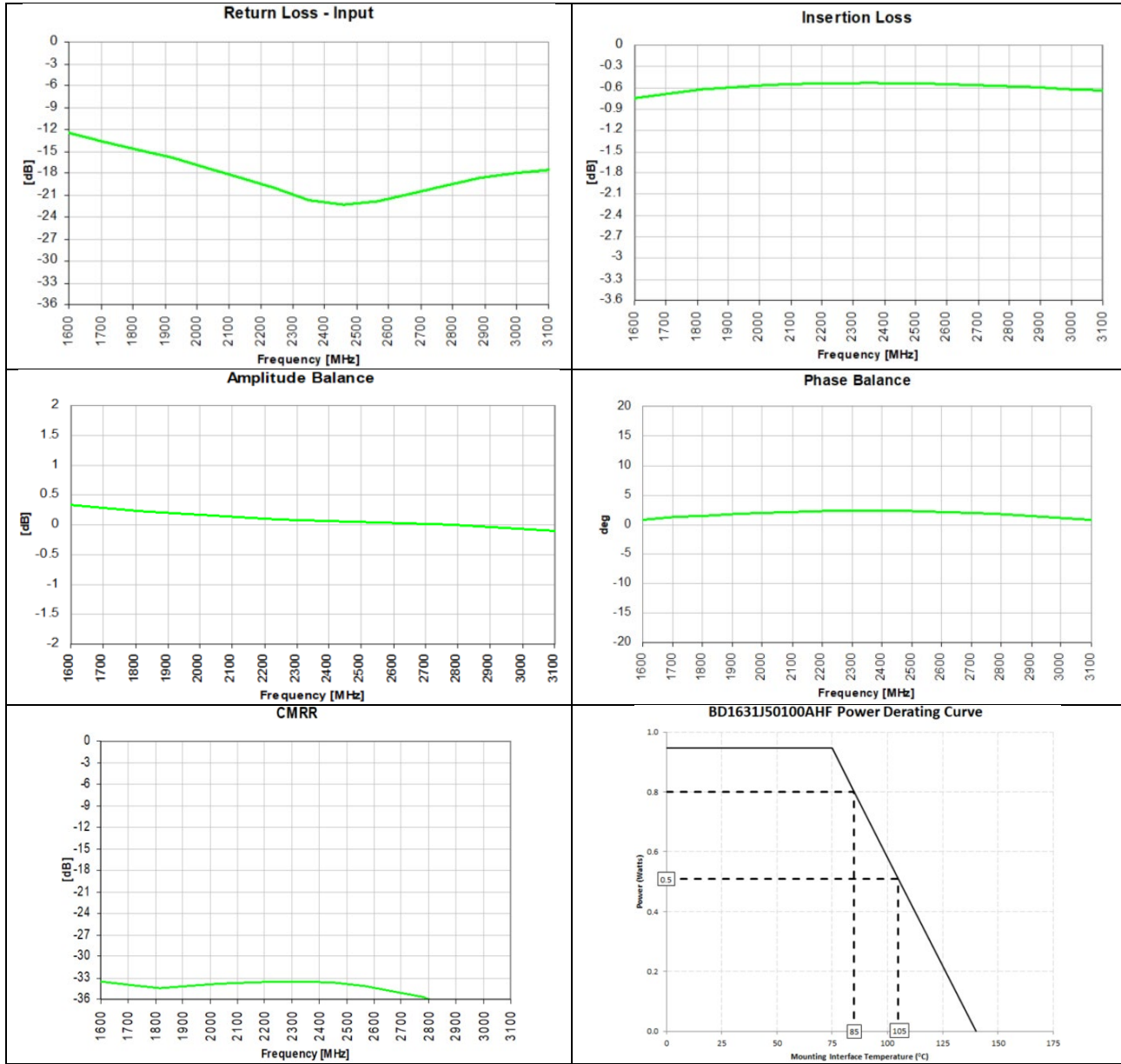

### Mounting Configuration:

In order for Xinger surface mount components to work optimally, the proper impedance transmission lines must be used to connect to the RF ports. If this condition is not satisfied, insertion loss, Isolation and VSWR may not meet published specifications.

All of the Xinger components are constructed from organic PTFE based composites which possess excellent electrical and mechanical stability. Xinger components are compliant to a variety of ROHS and Green standards and ready for Pb-free soldering processes. Pads are Gold plated with a Nickel barrier.

An example of the PCB footprint used in the testing of these parts is shown on the next page. An example of a DC-biased footprint is also shown on the next page. In specific designs, the transmission line widths need to be adjusted to the unique dielectric coefficients and thicknesses as well as varying pick and place equipment tolerances.

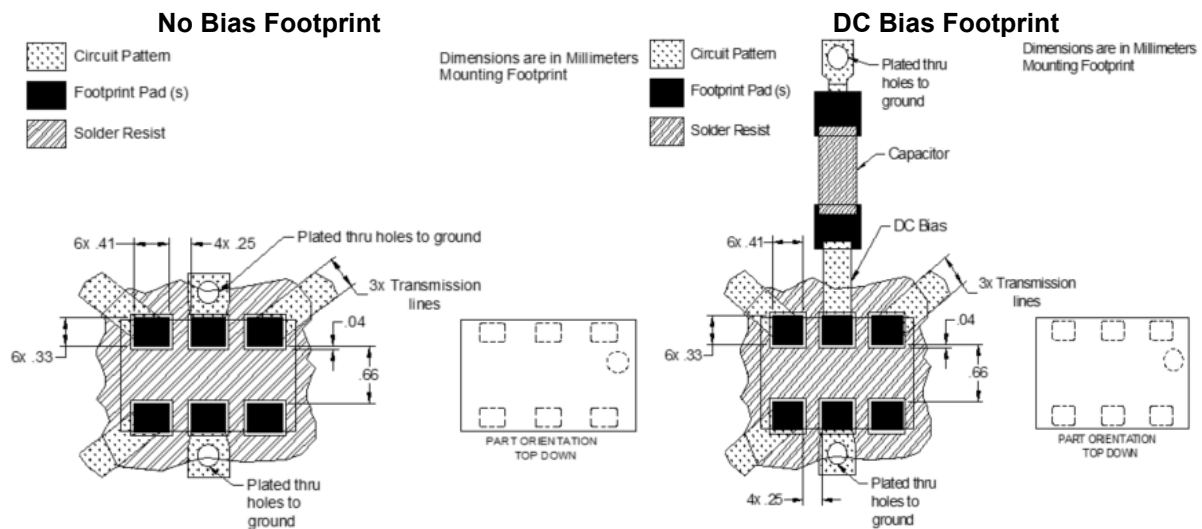

**Packaging and Ordering Information:**

Parts are available in reel and are packaged per EIA 481-D. Parts are oriented in tape and reel as shown below. Minimum order quantities are 4000 per reel.

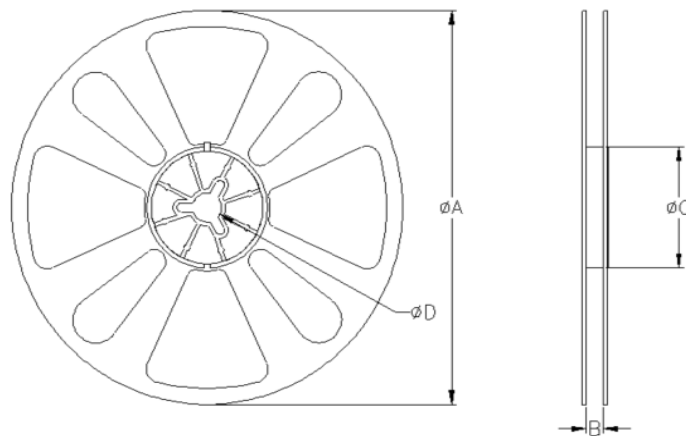
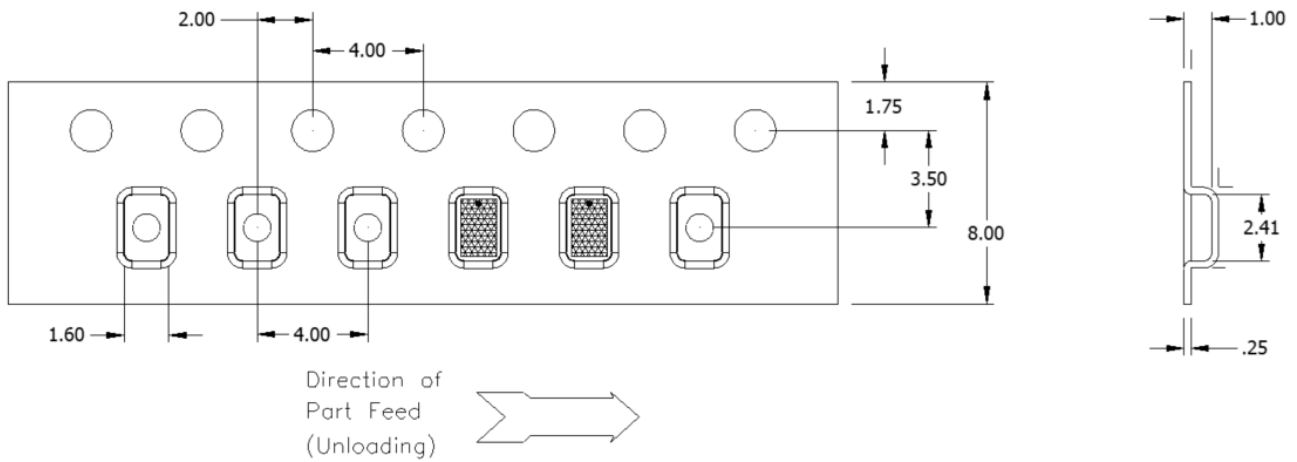

| TABLE 1       |                    |        |
|---------------|--------------------|--------|
| QUANTITY/REEL | REEL DIMENSIONS mm |        |
| 4000          | $\phi A$           | 177.80 |
|               | B                  | 8.00   |
|               | $\phi C$           | 50.80  |
|               | $\phi D$           | 13.00  |

Contact us:  
[rf&s\\_support@ttm.com](mailto:rf&s_support@ttm.com)