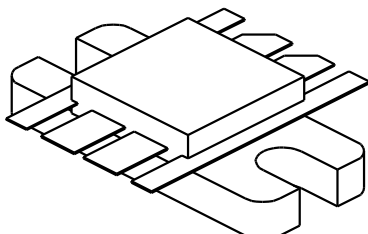

0204-125

125 Watts, 28 Volts, Class AB
Defcom 225 - 400 MHz

<p>GENERAL DESCRIPTION</p> <p>The 0204-125 is a double input matched COMMON EMITTER broadband transistor specifically intended for use in the 225-400 MHz frequency band. It may be operated in Class AB or C. Gold metallization and silicon diffused resistors ensure ruggedness and high reliability.</p>	<p>CASE OUTLINE 55JT- Style 2</p> 
<p>ABSOLUTE MAXIMUM RATINGS</p> <p>Maximum Power Dissipation @ 25°C 270 Watts</p> <p>Maximum Voltage and Current</p> <p>BVces Collector to Emitter Voltage 65 Volts BVebo Emitter to Base Voltage 4.0 Volts Ic Collector Current 16.0 A</p> <p>Maximum Temperatures</p> <p>Storage Temperature - 65 to +150°C Operating Junction Temperature +200°C</p>	

ELECTRICAL CHARACTERISTICS @ 25 °C

SYMBOL	CHARACTERISTICS	TEST CONDITIONS	MIN	TYP	MAX	UNITS
Pout	Power Output	F = 400 MHz	125			Watts
Pin	Power Input	Vcc = 28 Volts			25	Watts
Pg	Power Gain		7.0	8.5		dB
η_c	Efficiency			60		%
VSWR	Load Mismatch Tolerance				5:1	

BVebo ²	Emitter to Base Breakdown	Ie = 10 mA	4.0			Volts
BVces ²	Collector to Emitter Breakdown	Ic = 100 mA	60			Volts
BVceo ²	Collector to Emitter Breakdown	Ie = 100 mA	32			Volts
Cob ²	Output Capacitance	Vcb = 28 V, F = 1 MHz		70		pF
h_{FE} ²	DC - Current Gain	Vce = 5 V, Ic = 1 A	20		100	
θ_{jc}	Thermal Resistance				0.65	°C/W

Note 2: Per side

Issue August 1996

GHz TECHNOLOGY INC. RESERVES THE RIGHT TO MAKE CHANGES WITHOUT FURTHER NOTICE. GHz RECOMMENDS THAT BEFORE THE PRODUCT(S) DESCRIBED HEREIN ARE WRITTEN INTO SPECIFICATIONS, OR USED IN CRITICAL APPLICATIONS, THAT THE PERFORMANCE CHARACTERISTICS BE VERIFIED BY CONTACTING THE FACTORY.

DC SAFE OPERATING AREA

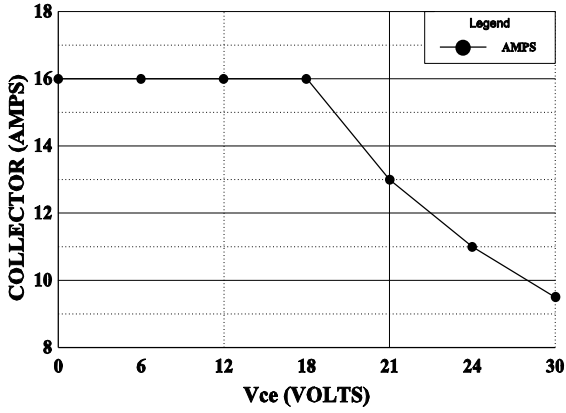

POWER OUTPUT vs POWER INPUT

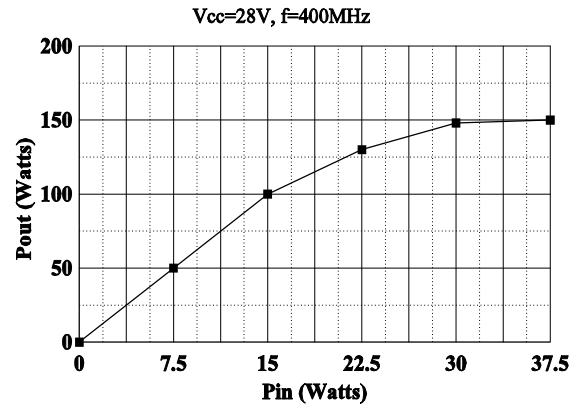

POWER GAIN VS FREQUENCY

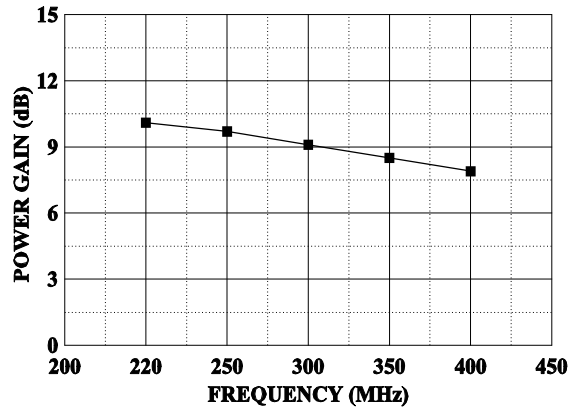

SERIES INPUT IMPEDANCE vs FREQUENCY

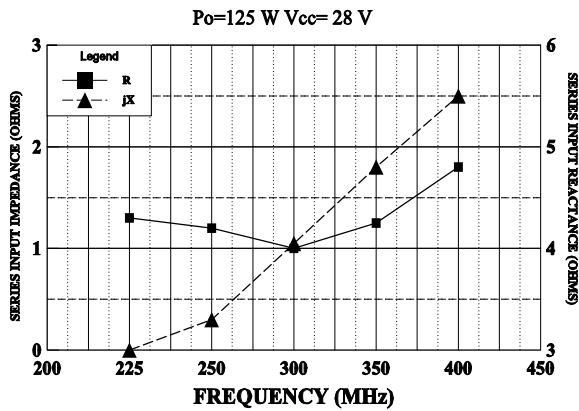

SERIES LOAD IMPEDANCE vs FREQUENCY

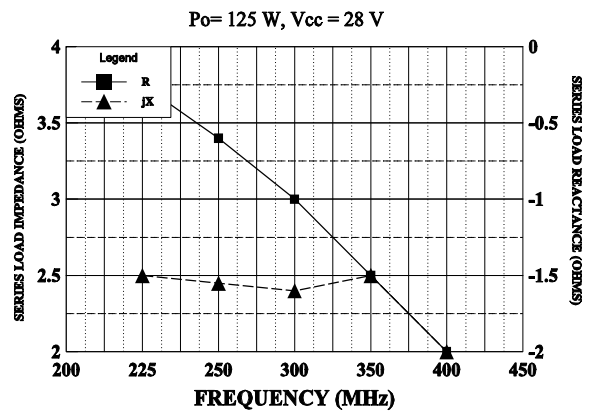

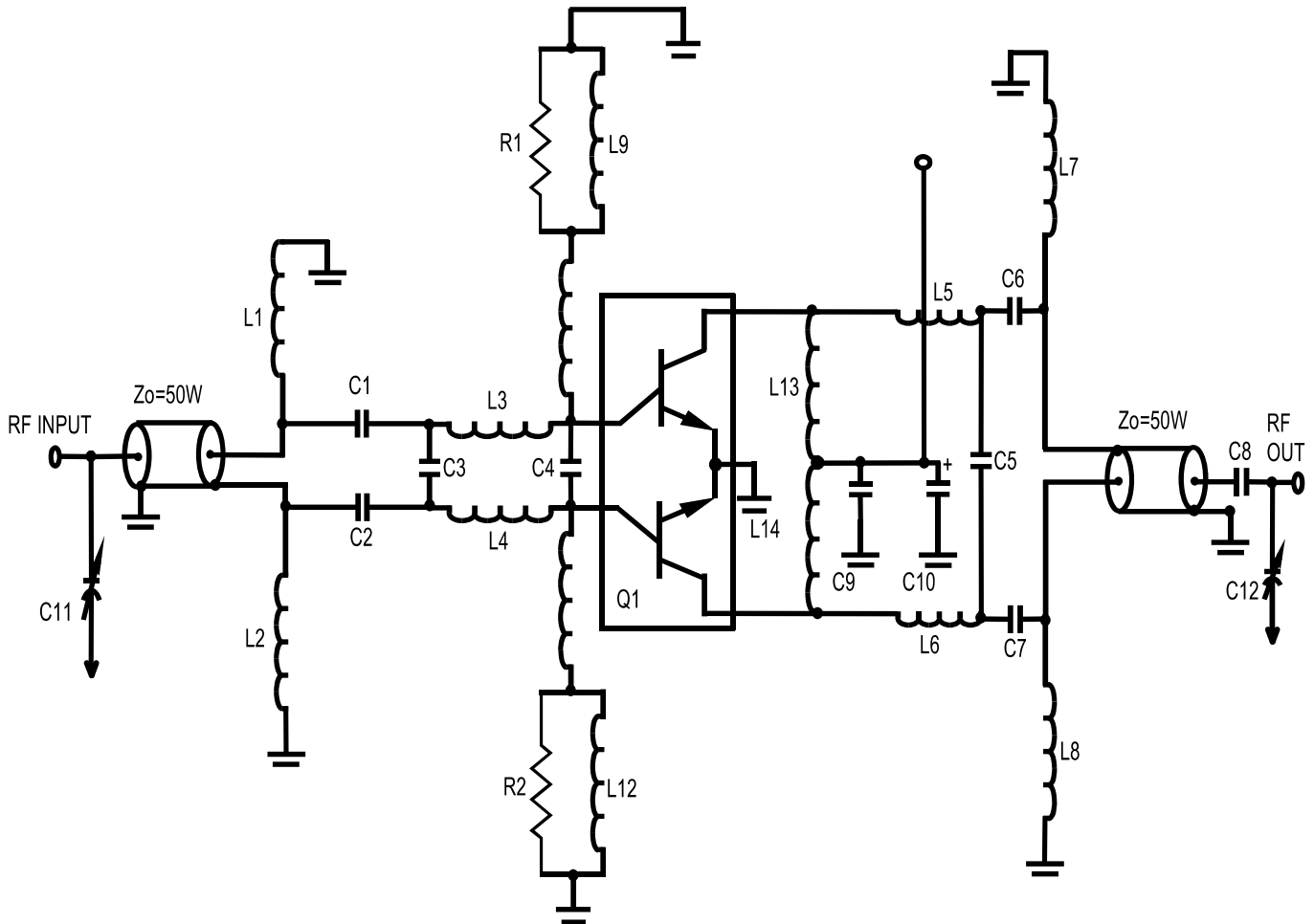

CAPACITORS

C1,C2=39pF ceramic chip capacitor
 C3=33pF ceramic chip capacitor
 C4=56pF ceramic chip capacitor
 C5=18pF ceramic chip capacitor
 C6,C7,C8=27pF ceramic chip capacitor
 C9=0.1mF ceramic capacitor
 C10=10mF electrolytic capacitor
 C11,C12=.5-10pF Johanson

INDUCTORS

L1,L2,L3,L4,L5,L6,L7,L8=printed
 on the circuit board
 L9,L12=4.7mH RF choke
 L10,L11,L13,L14=0.1mH RF choke

RESISTORS

R1,R2=10 OHM, 1/4 W

TRANSISTOR

Q1=0204-125