

Heterojunction Bipolar Transistor Technology (InGaP HBT)

Broadband High Linearity Amplifier

The MMG3001NT1 is a general purpose amplifier that is internally input and output matched. It is designed for a broad range of Class A, small-signal, high linearity, general purpose applications. It is suitable for applications with frequencies from 40 to 3600 MHz, such as cellular, PCS, BWA, WLL, PHS, CATV, VHF, UHF, UMTS and general small-signal RF.

Features

- Frequency: 40–3600 MHz
- P1dB: 18.5 dBm @ 900 MHz
- Small-Signal Gain: 20 dB @ 900 MHz
- Third Order Output Intercept Point: 32 dBm @ 900 MHz
- Single Voltage Supply
- Internally Matched to 50 Ohms
- Cost-effective SOT-89 Surface Mount Plastic Package
- In Tape and Reel. T1 Suffix = 1,000 Units, 12 mm Tape Width, 7-inch Reel.

MMG3001NT1

**40–3600 MHz, 20 dB
18.5 dBm
InGaP HBT GPA**

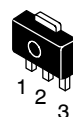

SOT-89

LIFETIME BUY

LAST SHIP 24 MAY 15
LAST ORDER 24 MAY 14

Table 1. Typical Performance (1)

Characteristic	Symbol	900 MHz	2140 MHz	3500 MHz	Unit
Small-Signal Gain (S21)	G _p	20	18	16	dB
Input Return Loss (S11)	IRL	-25	-25	-19	dB
Output Return Loss (S22)	ORL	-22	-18	-17	dB
Power Output @1dB Compression	P1dB	18.5	18	15.5	dBm
Third Order Output Intercept Point	OIP3	32	31	28.5	dBm

1. V_{CC} = 5.6 Vdc, T_A = 25°C, 50 ohm system.

Table 2. Maximum Ratings

Rating	Symbol	Value	Unit
Supply Voltage	V _{CC}	7	V
Supply Current	I _{CC}	300	mA
RF Input Power	P _{in}	10	dBm
Storage Temperature Range	T _{stg}	-65 to +150	°C
Junction Temperature	T _J	150	°C

Table 3. Thermal Characteristics

Characteristic	Symbol	Value (2)	Unit
Thermal Resistance, Junction to Case Case Temperature 123°C, 5.6 Vdc, 58 mA, no RF applied	R _{θJC}	92.0	°C/W

2. Refer to AN1955, *Thermal Measurement Methodology of RF Power Amplifiers*. Go to <http://www.freescale.com/rf>. Select Documentation/Application Notes - AN1955.

Table 4. Electrical Characteristics ($V_{CC} = 5.6$ Vdc, 900 MHz, $T_A = 25^\circ\text{C}$, 50 ohm system, in Freescale Application Circuit)

Characteristic	Symbol	Min	Typ	Max	Unit
Small-Signal Gain (S21)	G_p	18	20	—	dB
Input Return Loss (S11)	IRL	—	-25	—	dB
Output Return Loss (S22)	ORL	—	-22	—	dB
Power Output @ 1dB Compression	P1dB	—	18.5	—	dBm
Third Order Output Intercept Point	OIP3	—	32	—	dBm
Noise Figure	NF	—	4.1	—	dB
Supply Current	I_{CC}	40	58	75	mA
Supply Voltage	V_{CC}	—	5.6	—	V

Table 5. Functional Pin Description

Pin Number	Pin Function
1	RF_{in}
2	Ground
3	RF_{out}/DC Supply

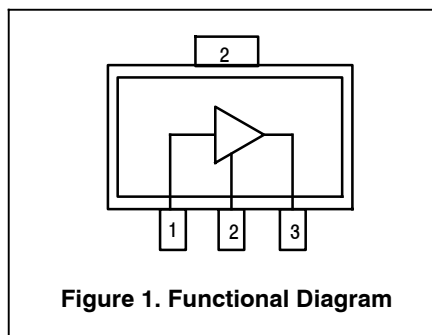

Table 6. ESD Protection Characteristics

Test Conditions/Test Methodology	Class
Human Body Model (per JESD 22-A114)	0
Machine Model (per EIA/JESD 22-A115)	A
Charge Device Model (per JESD 22-C101)	IV

Table 7. Moisture Sensitivity Level

Test Methodology	Rating	Package Peak Temperature	Unit
Per JESD 22-A113, IPC/JEDEC J-STD-020	1	260	$^\circ\text{C}$

LIFETIME BUY

LAST ORDER 24 MAY 14 LAST SHIP 24 MAY 15

50 OHM TYPICAL CHARACTERISTICS

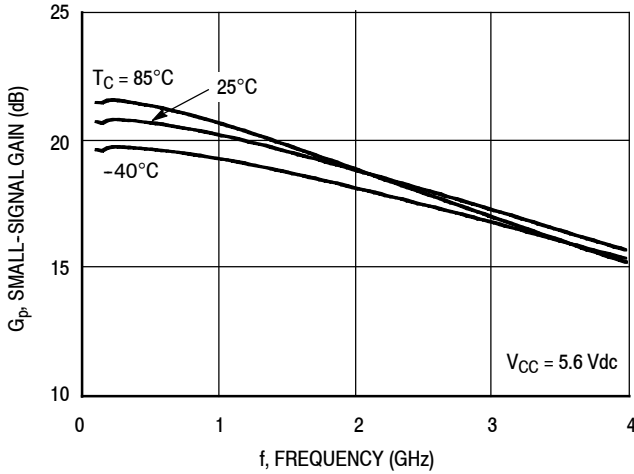

Figure 2. Small-Signal Gain (S21) versus Frequency

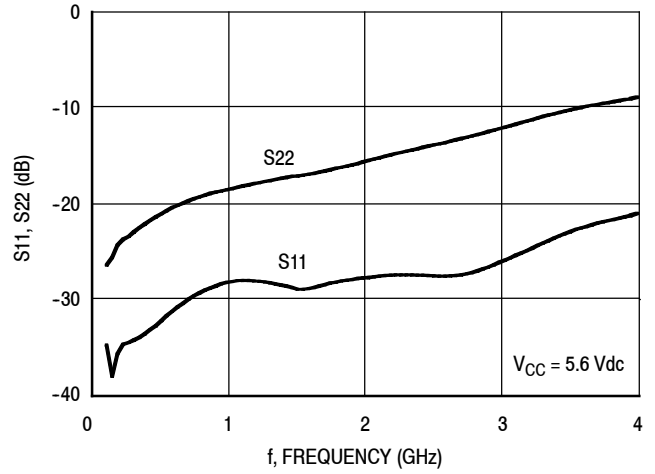

Figure 3. Input/Output Return Loss versus Frequency

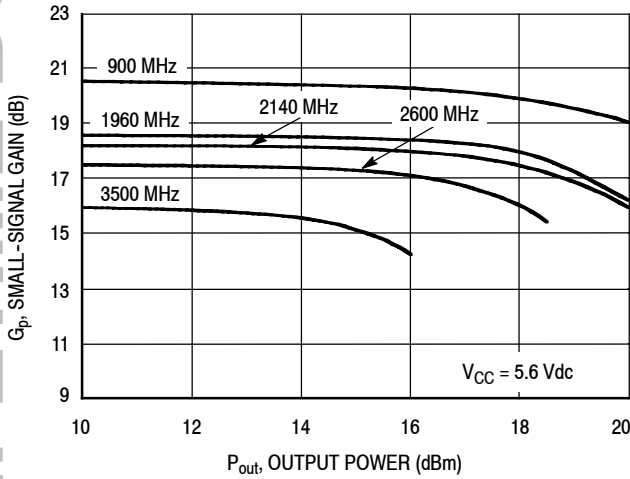

Figure 4. Small-Signal Gain versus Output Power

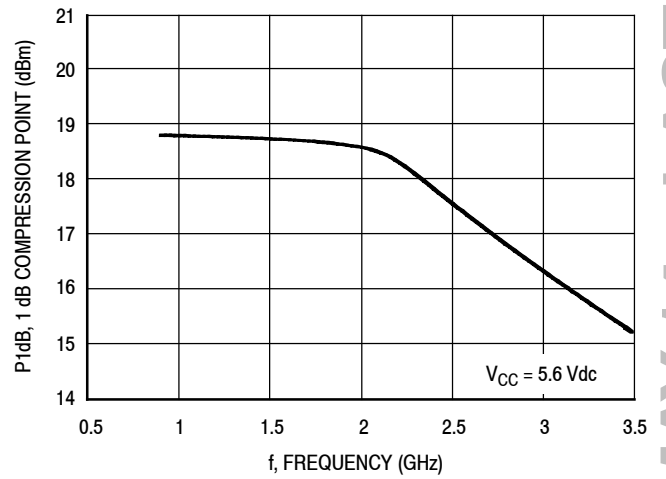

Figure 5. P1dB versus Frequency

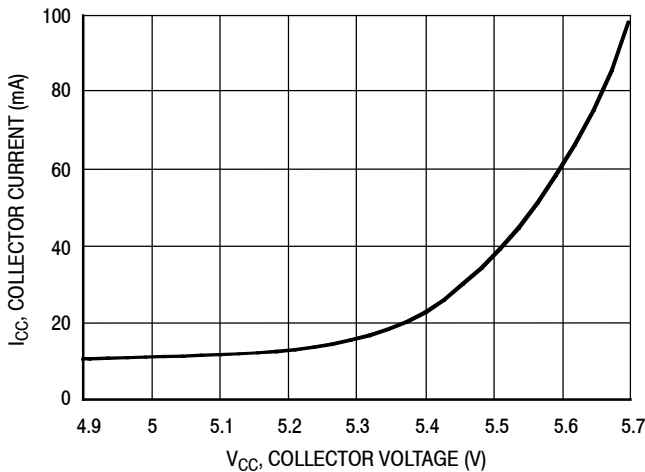

Figure 6. Collector Current versus Collector Voltage

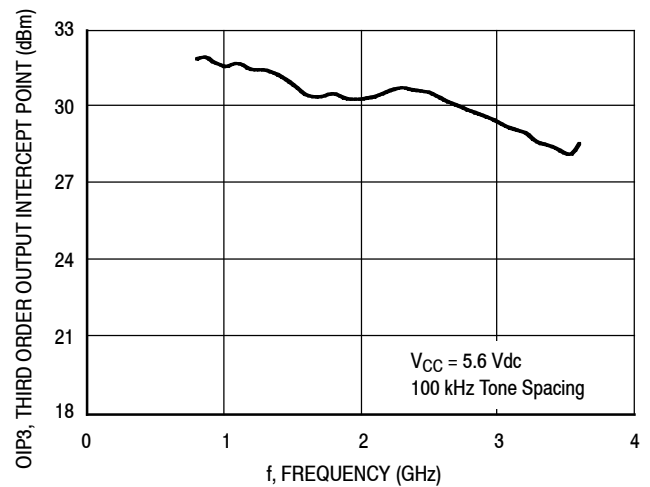

Figure 7. Third Order Output Intercept Point versus Frequency

LIFETIME BUY

LAST ORDER 24 MAY 14 LAST SHIP 24 MAY 15

50 OHM TYPICAL CHARACTERISTICS

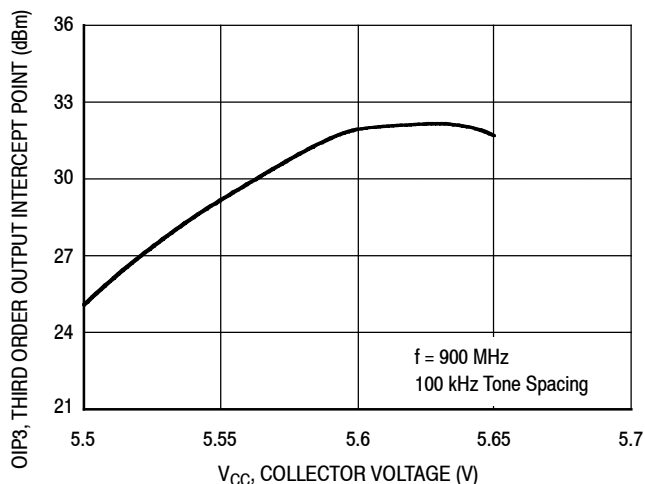

Figure 8. Third Order Output Intercept Point versus Collector Voltage

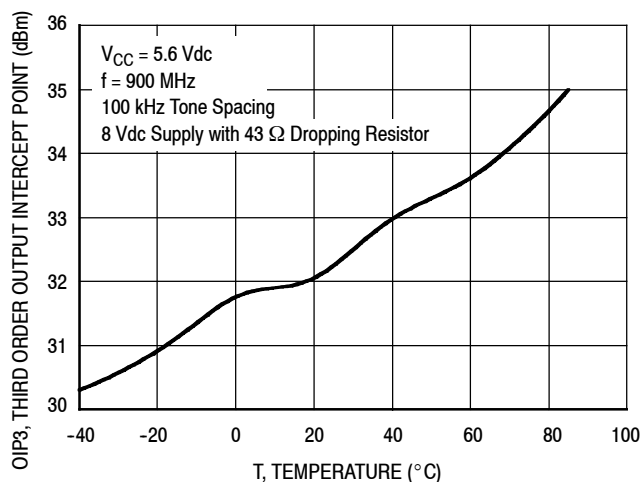

Figure 9. Third Order Output Intercept Point versus Case Temperature

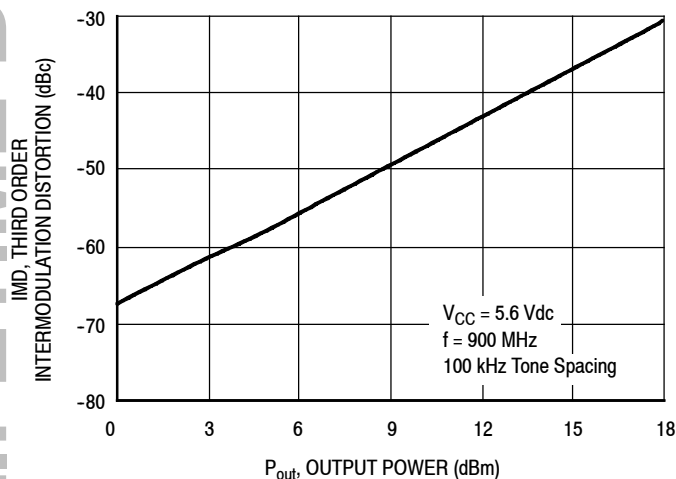
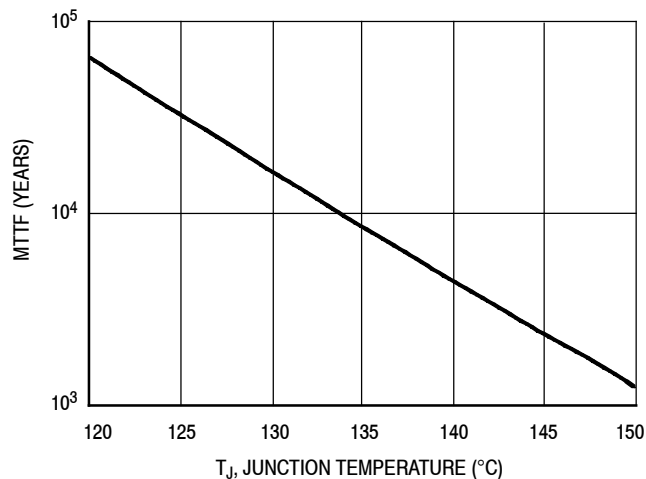

Figure 10. Third Order Intermodulation Distortion versus Output Power



NOTE: The MTTF is calculated with $V_{CC} = 5.6$ Vdc, $I_{CC} = 58$ mA

Figure 11. MTTF versus Junction Temperature

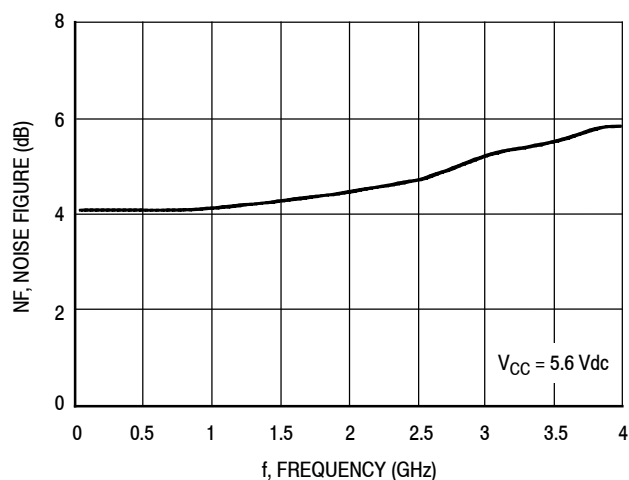

Figure 12. Noise Figure versus Frequency

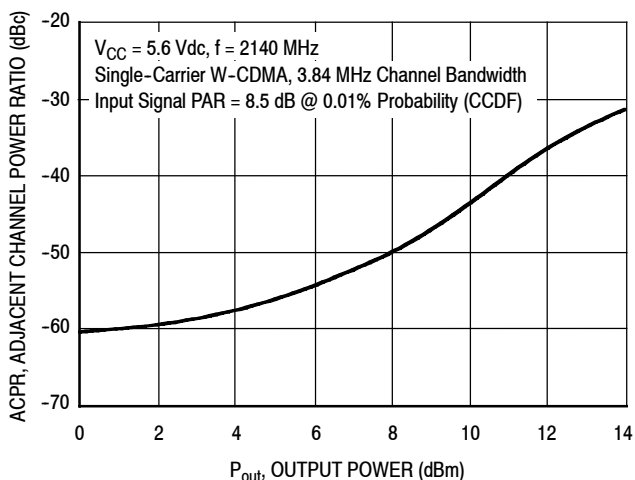

Figure 13. Single-Carrier W-CDMA Adjacent Channel Power Ratio versus Output Power

LIFETIME BUY

LAST ORDER 24 MAY 14 LAST SHIP 24 MAY 15

50 OHM APPLICATION CIRCUIT: 40-800 MHz

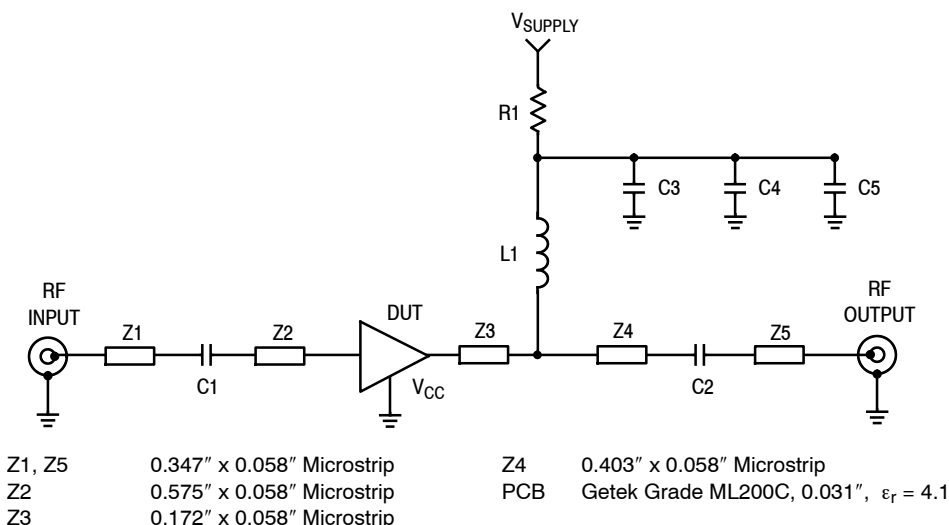

Figure 14. 50 Ohm Test Circuit Schematic

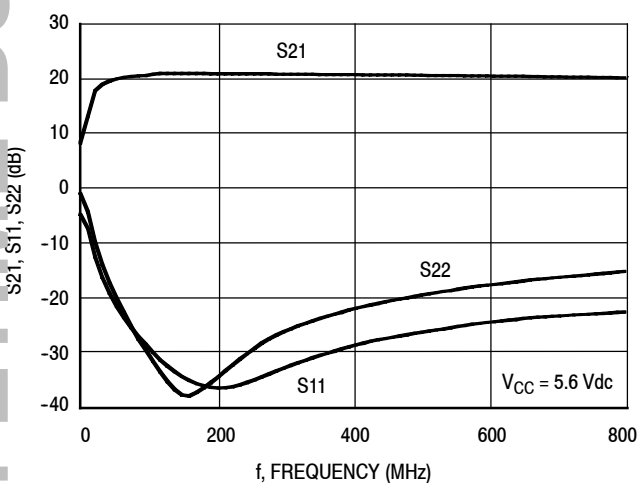

Figure 15. S21, S11 and S22 versus Frequency

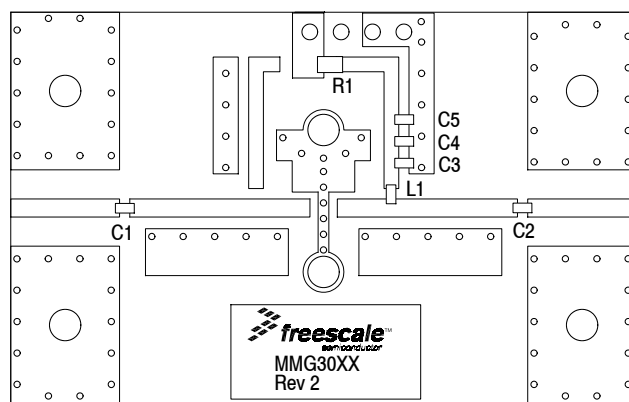

Figure 16. 50 Ohm Test Circuit Component Layout

Table 8. 50 Ohm Test Circuit Component Designations and Values

Part	Description	Part Number	Manufacturer
C1, C2, C3	0.01 μ F Chip Capacitors	C0603C103J5RAC	Kemet
C4	1000 pF Chip Capacitor	C0603C102J5RAC	Kemet
C5	47 pF Chip Capacitor	C0805C470J5RAC	Kemet
L1	470 nH Chip Inductor	BK2125HM471-T	Taiyo Yuden
R1	8.2 Ω Chip Resistor	RK73B2ATTE8R2J	KOA Speer

Table 9. Supply Voltage versus R1 Values

Supply Voltage	6	7	8	9	10	11	12	V
R1 Value	6.9	24	41	59	76	93	110	Ω

Note: To provide $V_{CC} = 5.6$ Vdc and $I_{CC} = 58$ mA at the device.

LIFETIME BUY

LAST SHIP 24 MAY 15
LAST ORDER 24 MAY 14

50 OHM APPLICATION CIRCUIT: 800-3600 MHz

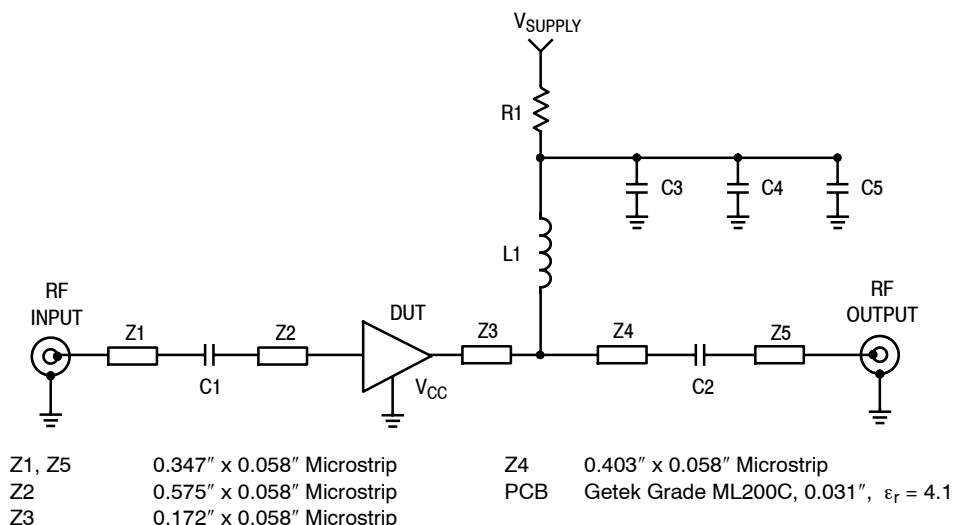

Figure 17. 50 Ohm Test Circuit Schematic

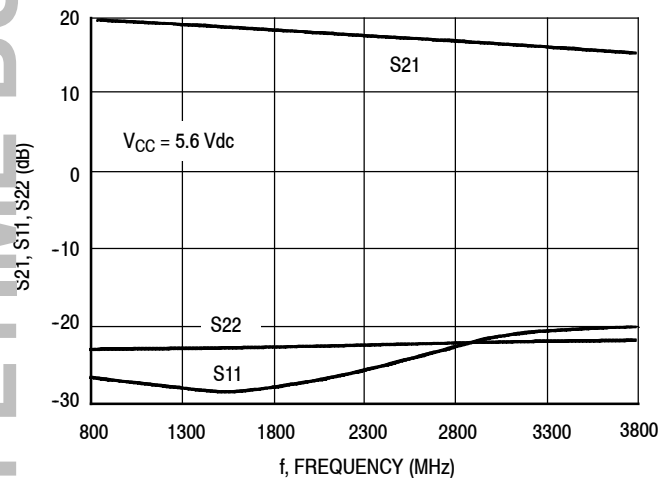

Figure 18. S21, S11 and S22 versus Frequency

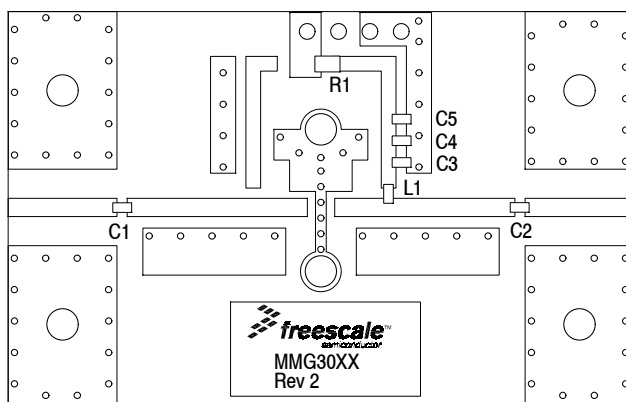

Figure 19. 50 Ohm Test Circuit Component Layout

Table 10. 50 Ohm Test Circuit Component Designations and Values

Part	Description	Part Number	Manufacturer
C1, C2	39 pF Chip Capacitors	C0805C390J5RAC	Kemet
C3	0.01 μ F Chip Capacitor	C0603C103J5RAC	Kemet
C4	1000 pF Chip Capacitor	C0603C102J5RAC	Kemet
C5	47 pF Chip Capacitor	C0805C470J5RAC	Kemet
L1	56 nH Chip Inductor	HK160856NJ-T	Taiyo Yuden
R1	8.2 Ω Chip Resistor	RK73B2ATTE8R2J	KOA Speer

50 OHM TYPICAL CHARACTERISTICS

Table 11. Common Emitter S-Parameters ($V_{CC} = 5.6 \text{ Vdc}$, $T_A = 25^\circ\text{C}$, 50 Ohm System)

f MHz	S ₁₁		S ₂₁		S ₁₂		S ₂₂	
	S ₁₁	∠ φ	S ₂₁	∠ φ	S ₁₂	∠ φ	S ₂₂	∠ φ
100	0.01837	0.158	10.80154	176.164	0.06918	0.196	0.04789	11.134
150	0.00937	-92.445	10.61985	173.508	0.06785	-0.796	0.05071	-49.334
200	0.02263	96.518	11.06276	170.083	0.07095	-2.253	0.07322	-17.196
250	0.02049	101.715	10.97614	167.952	0.07046	-2.513	0.06689	-28.31
300	0.02015	91.299	10.93416	165.552	0.07052	-2.899	0.07111	-35.935
350	0.01939	77.961	10.89886	163.145	0.07044	-3.499	0.07696	-41.106
400	0.0212	71.36	10.85777	160.903	0.07055	-3.885	0.08093	-47.831
450	0.02169	63.516	10.81348	158.599	0.07053	-4.455	0.08609	-52.772
500	0.02447	55.112	10.76682	156.269	0.07056	-4.766	0.09084	-57.016
550	0.02643	49.889	10.71841	154.026	0.07058	-5.297	0.09479	-60.897
600	0.02857	47.303	10.67367	151.767	0.07057	-5.783	0.09752	-65.139
650	0.03094	43.937	10.61782	149.477	0.07066	-6.195	0.1016	-69.112
700	0.03356	42.055	10.56473	147.215	0.07064	-6.702	0.10489	-72.747
750	0.03495	40.001	10.50489	144.98	0.07073	-7.082	0.10746	-76.469
800	0.03599	38.298	10.44613	142.748	0.07084	-7.625	0.11046	-80.336
850	0.03675	36.713	10.38955	140.536	0.07089	-8.108	0.11345	-84.309
900	0.0378	34.449	10.32195	138.333	0.07106	-8.539	0.11524	-88.629
950	0.04014	35.697	10.26867	136.075	0.07101	-8.95	0.11712	-93.045
1000	0.03975	34.93	10.19351	133.939	0.07128	-9.497	0.11971	-97.401
1050	0.04101	35.048	10.13374	131.742	0.07142	-10.015	0.12057	-101.389
1100	0.0413	34.972	10.05555	129.606	0.07148	-10.588	0.12293	-106.494
1150	0.04078	36.31	9.98381	127.42	0.07156	-10.989	0.12475	-111.339
1200	0.04045	38.732	9.90685	125.299	0.07171	-11.51	0.12702	-115.996
1250	0.04005	39.914	9.83535	123.178	0.07179	-12.025	0.12882	-120.553
1300	0.03952	43.011	9.76304	121.077	0.07197	-12.554	0.13202	-125.245
1350	0.03786	44.538	9.68157	118.951	0.07208	-13.057	0.13502	-129.596
1400	0.03796	46.354	9.60628	116.874	0.07224	-13.606	0.13836	-133.849
1450	0.03675	48.792	9.52474	114.777	0.07243	-14.151	0.14227	-138.332
1500	0.03229	27.259	9.45514	112.739	0.07269	-14.685	0.13499	-140.027
1550	0.03309	25.231	9.36984	110.697	0.0728	-15.204	0.13808	-143.203
1600	0.03475	23.271	9.29518	108.724	0.07296	-15.823	0.14111	-146.041
1650	0.0367	22.494	9.2159	106.764	0.07327	-16.372	0.14376	-149.267
1700	0.03803	21.485	9.15729	104.763	0.07341	-16.955	0.14728	-152.506
1750	0.03976	21.793	9.07502	102.811	0.07361	-17.538	0.14882	-155.031
1800	0.04035	21.332	9.00137	100.821	0.07373	-18.047	0.15301	-157.889
1850	0.04093	21.941	8.92666	98.873	0.07383	-18.59	0.15553	-160.786
1900	0.0409	20.661	8.84934	96.931	0.07407	-19.216	0.1587	-163.24
1950	0.04127	17.824	8.75854	95.008	0.07433	-19.75	0.1617	-165.666
2000	0.04055	20.129	8.69148	93.046	0.07451	-20.324	0.1659	-168.355
2050	0.04148	18.841	8.6161	91.185	0.07482	-20.966	0.16929	-170.838
2100	0.04198	18.596	8.5446	89.293	0.07498	-21.435	0.17351	-173.6
2150	0.04249	18.599	8.47505	87.398	0.07512	-22.217	0.17715	-176.054
2200	0.04309	19.388	8.39794	85.501	0.07543	-22.79	0.18032	-178.865
2250	0.04316	19.789	8.32788	83.624	0.0756	-23.41	0.18422	178.51

(continued)

MMG3001NT1

LIFETIME BUY

LAST ORDER 24 MAY 14 LAST SHIP 24 MAY 15

50 OHM TYPICAL CHARACTERISTICS

Table 11. Common Emitter S-Parameters ($V_{CC} = 5.6$ Vdc, $T_A = 25^\circ\text{C}$, 50 Ohm System) (continued)

f MHz	S ₁₁		S ₂₁		S ₁₂		S ₂₂	
	S ₁₁	∠ φ	S ₂₁	∠ φ	S ₁₂	∠ φ	S ₂₂	∠ φ
2300	0.04326	21.542	8.24837	81.777	0.07591	-24.034	0.1871	175.803
2350	0.04285	23.93	8.17883	79.926	0.0761	-24.632	0.19081	173.166
2400	0.0428	25.661	8.10402	78.094	0.07638	-25.226	0.19358	170.371
2450	0.04222	28.349	8.0349	76.296	0.07665	-25.841	0.19769	167.872
2500	0.04157	30.594	7.96381	74.438	0.07693	-26.474	0.20079	164.997
2550	0.04062	32.718	7.89112	72.648	0.07715	-27.199	0.20422	162.204
2600	0.04117	35.498	7.83503	70.815	0.07744	-27.904	0.20869	159.371
2650	0.0407	39.668	7.76263	69.011	0.07768	-28.528	0.21293	156.39
2700	0.04099	40.736	7.68838	67.13	0.07806	-29.281	0.21614	153.567
2750	0.04248	44.129	7.62088	65.378	0.07826	-29.943	0.22114	150.373
2800	0.04329	47.509	7.55264	63.561	0.0785	-30.741	0.226	147.517
2850	0.04466	51.043	7.48275	61.767	0.07867	-31.392	0.23048	144.417
2900	0.04661	53.041	7.41535	60.019	0.07893	-32.182	0.23581	141.675
2950	0.04876	57.415	7.34593	58.235	0.07915	-32.903	0.24106	138.661
3000	0.04991	59.701	7.28251	56.493	0.07945	-33.641	0.24698	136.002
3050	0.05208	61.593	7.21536	54.703	0.07976	-34.4	0.25213	133.272
3100	0.05426	64.102	7.1502	52.913	0.07989	-35.181	0.25854	130.712
3150	0.05536	65.235	7.08162	51.15	0.08017	-35.962	0.26426	128.119
3200	0.05758	65.884	7.01653	49.405	0.08027	-36.771	0.27078	125.669
3250	0.06021	66.564	6.94732	47.655	0.08054	-37.539	0.27729	123.284
3300	0.06243	66.702	6.88222	45.916	0.08071	-38.36	0.28468	120.844
3350	0.06498	65.787	6.81808	44.235	0.08097	-39.051	0.29005	118.633
3400	0.06832	65.869	6.75612	42.521	0.08112	-39.867	0.29718	116.391
3450	0.07049	65.731	6.69433	40.809	0.08128	-40.621	0.3026	114.187
3500	0.07294	65.097	6.63494	39.085	0.08144	-41.453	0.30819	112.291
3550	0.07565	65.299	6.57111	37.382	0.08171	-42.369	0.31389	110.431
3600	0.07682	64.978	6.51018	35.707	0.08186	-43.091	0.31878	108.662

LIFETIME BUY

LAST ORDER 24 MAY 14 LAST SHIP 24 MAY 15

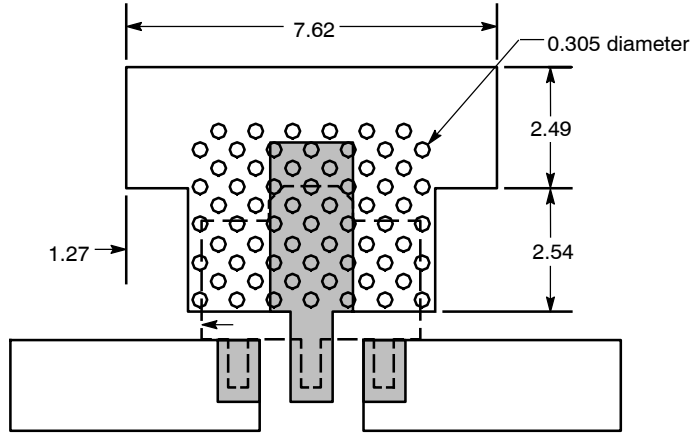
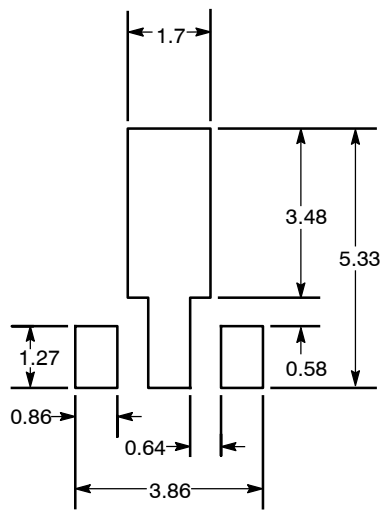

- NOTES:
1. THERMAL AND RF GROUNDING CONSIDERATIONS SHOULD BE USED IN PCB LAYOUT DESIGN.
 2. DEPENDING ON PCB DESIGN RULES, AS MANY VIAS AS POSSIBLE SHOULD BE PLACED ON THE LANDING PATTERN.
 3. IF VIAS CANNOT BE PLACED ON THE LANDING PATTERN, THEN AS MANY VIAS AS POSSIBLE SHOULD BE PLACED AS CLOSE TO THE LANDING PATTERN AS POSSIBLE FOR OPTIMAL THERMAL AND RF PERFORMANCE.
 4. RECOMMENDED VIA PATTERN SHOWN HAS 0.381 x 0.762 MM PITCH.

Figure 20. Recommended Mounting Configuration

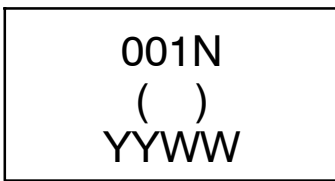
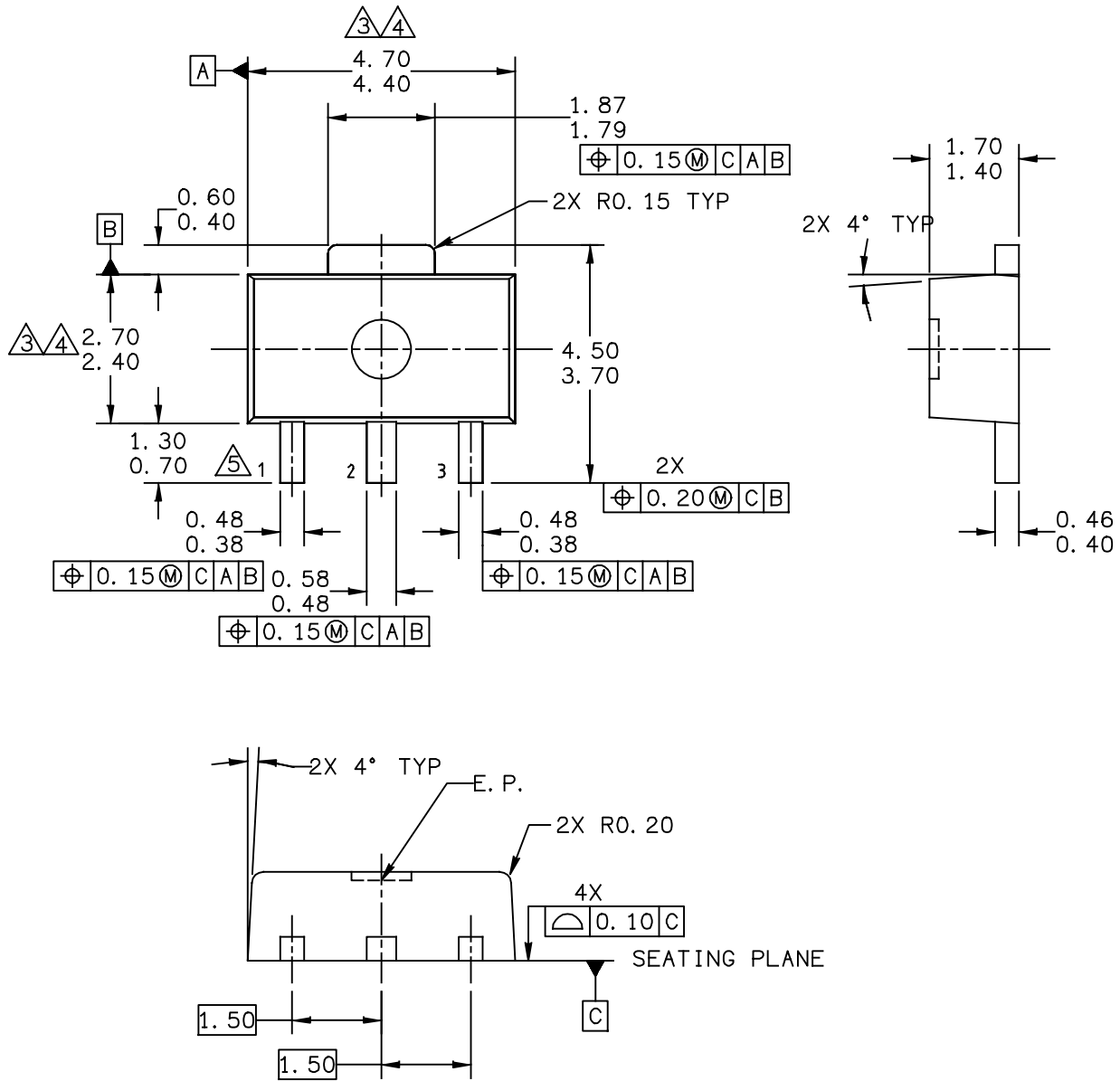
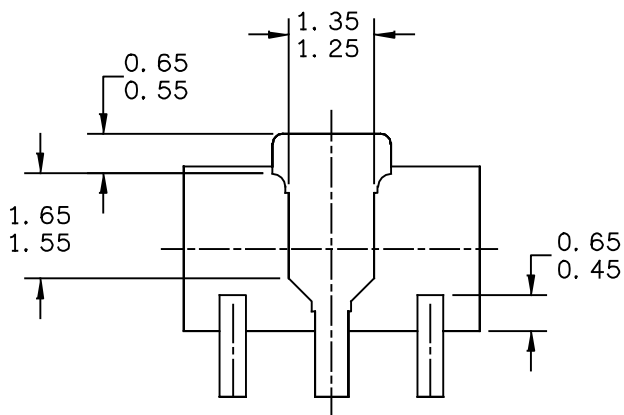

Figure 21. Product Marking

PACKAGE DIMENSIONS



© FREESCALE SEMICONDUCTOR, INC. ALL RIGHTS RESERVED.	MECHANICAL OUTLINE	PRINT VERSION NOT TO SCALE	
TITLE: SOT-89, 4 LEAD, 4.5 X 2.5 PKG, 1.5 MM PITCH	DOCUMENT NO: 98ASA10586D	REV: D	
	CASE NUMBER: 1514-02	27 JUN 2007	
	STANDARD: NON-JEDEC		



BOTTOM VIEW

CASE STYLE:

STYLE 1:

PIN 1. RF INPUT
 PIN 2. GROUND
 PIN 3. RF OUTPUT

STYLE 2:

PIN 1. GATE
 PIN 2. SOURCE
 PIN 3. DRAIN

© FREESCALE SEMICONDUCTOR, INC. ALL RIGHTS RESERVED.	MECHANICAL OUTLINE	PRINT VERSION NOT TO SCALE	
TITLE: SOT-89, 4 LEAD, 4.5 X 2.5 PKG, 1.5 MM PITCH	DOCUMENT NO: 98ASA10586D	REV: D	
	CASE NUMBER: 1514-02	27 JUN 2007	
	STANDARD: NON-JEDEC		

NOTES:

1 DIMENSIONING AND TOLERANCING PER ASME Y14.5M – 1994.

2 ALL DIMENSIONS ARE IN MILLIMETERS.

3 DIMENSIONS DOES NOT INCLUDE MOLD FLASH. PROTRUSIONS OR GATE BURRS. MOLD FLASH, PROTRUSIONS OR GATE BURRS SHALL NOT EXCEED 0.5mm PER END. DIMENSION DOES NOT INCLUDE INTERLEAD FLASH OR PROTRUSION. INTERLEAD FLASH OR PROTRUSION SHALL NOT EXCEED 0.5 mm PER SIDE.

4 DIMENSION ARE DETERMINED AT THE OUTMOST EXTREMES OF THE PLASTIC BODY EXCLUSIVE OF MOLD FLASH, TIE BAR BURRS, GATE BURRS AND INTERLEAD FLASH, BUT INCLUDING ANY MISMATCH BETWEEN THE TOP AND BOTTOM OF THE PLASTIC BODY.

5 TERMINAL NUMBERS ARE SHOWN FOR REFERENCE ONLY.

© FREESCALE SEMICONDUCTOR, INC. ALL RIGHTS RESERVED.	MECHANICAL OUTLINE	PRINT VERSION NOT TO SCALE	
TITLE: SOT-89, 4 LEAD, 4.5 X 2.5 PKG, 1.5 MM PITCH	DOCUMENT NO: 98ASA10586D	REV: D	
	CASE NUMBER: 1514-02	27 JUN 2007	
	STANDARD: NON-JEDEC		

Refer to the following resources to aid your design process.

Application Notes

- AN1955: Thermal Measurement Methodology of RF Power Amplifiers
- AN3100: General Purpose Amplifier and MMIC Biasing

Software

- .s2p File

For Software, do a Part Number search at <http://www.freescale.com>, and select the “Part Number” link. Go to Software & Tools on the part’s Product Summary page to download the respective tool.

FAILURE ANALYSIS

At this time, because of the physical characteristics of the part, failure analysis is limited to electrical signature analysis. In cases where Freescale is contractually obligated to perform failure analysis (FA) services, full FA may be performed by third party vendors with moderate success. For updates contact your local Freescale Sales Office.

REVISION HISTORY

The following table summarizes revisions to this document.

Revision	Date	Description
5	Mar. 2007	<ul style="list-style-type: none"> • Corrected and updated Part Numbers in Tables 8 and 10, Component Designations and Values, to RoHS compliant part numbers, pp. 6, 7
6	July 2007	<ul style="list-style-type: none"> • Replaced Case Outline 1514-01 with 1514-02, Issue D, pp. 1, 11-13. Case updated to add missing dimension for Pin 1 and Pin 3.
7	Mar. 2008	<ul style="list-style-type: none"> • Removed Footnote 2, Continuous voltage and current applied to device, from Table 2, Maximum Ratings, p. 1 • Corrected Fig. 13, Single-Carrier W-CDMA Adjacent Channel Power Ratio versus Output Power y-axis (ACPR) unit of measure to dBc, p. 5 • Corrected S-Parameter table frequency column label to read “MHz” versus “GHz” and corrected frequency values from GHz to MHz, pp. 8, 9
8	Feb. 2012	<ul style="list-style-type: none"> • Corrected temperature at which Theta_{JC} is measured from 25°C to 123°C and added “no RF applied” to Thermal Characteristics table to indicate that thermal characterization is performed under DC test with no RF signal applied, p. 1 • Table 6, ESD Protection Characteristics, removed the word “Minimum” after the ESD class rating. ESD ratings are characterized during new product development but are not 100% tested during production. ESD ratings provided in the data sheet are intended to be used as a guideline when handling ESD sensitive devices, p. 3 • Removed I_{CC} bias callout from applicable graphs and Table 11, Common Emitter S-Parameters heading as bias is not a controlled value, pp. 4-9 • Added .s2p File availability to Product Software, p. 14
9	Oct. 2014	<ul style="list-style-type: none"> • Added Fig. 21, Product Marking, p. 9 • Added Failure Analysis information, p. 13

LIFETIME BUY

LAST ORDER 24 MAY 14 LAST SHIP 24 MAY 15

How to Reach Us:

Home Page:
freescale.com

Web Support:
freescale.com/support

Information in this document is provided solely to enable system and software implementers to use Freescale products. There are no express or implied copyright licenses granted hereunder to design or fabricate any integrated circuits based on the information in this document.

Freescale reserves the right to make changes without further notice to any products herein. Freescale makes no warranty, representation, or guarantee regarding the suitability of its products for any particular purpose, nor does Freescale assume any liability arising out of the application or use of any product or circuit, and specifically disclaims any and all liability, including without limitation consequential or incidental damages. "Typical" parameters that may be provided in Freescale data sheets and/or specifications can and do vary in different applications, and actual performance may vary over time. All operating parameters, including "typicals," must be validated for each customer application by customer's technical experts. Freescale does not convey any license under its patent rights nor the rights of others. Freescale sells products pursuant to standard terms and conditions of sale, which can be found at the following address: freescale.com/SalesTermsandConditions.

Freescale and the Freescale logo are trademarks of Freescale Semiconductor, Inc., Reg. U.S. Pat. & Tm. Off. All other product or service names are the property of their respective owners.

© 2004–2008, 2012, 2014 Freescale Semiconductor, Inc.