

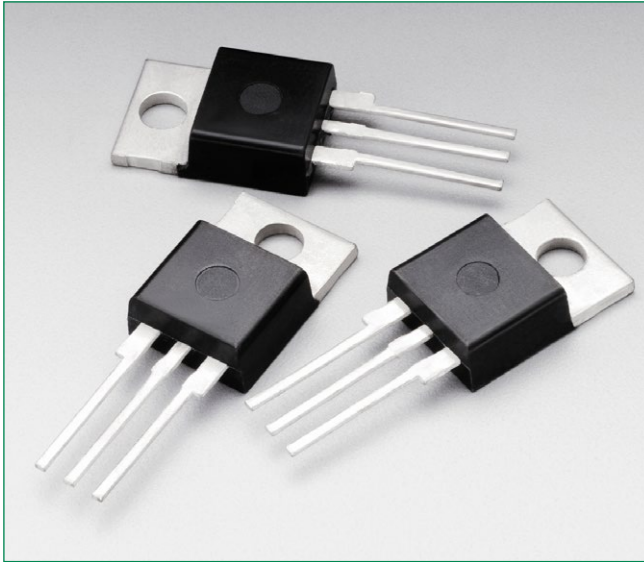

BTA08-800CW3G



Description

Designed primarily for half-wave ac control applications, such as motor controls, heating controls and power supply crowbar circuits.

Features

- Blocking Voltage to 800 V
- On-State Current Rating of 8 A RMS at 25°C
- Uniform Gate Trigger Currents in Three Quadrants
- High Immunity to dV/dt – 1500 V/μs minimum at 125°C
- Minimizes Snubber Networks for Protection
- Industry Standard TO-220AB Package
- High Commutating di/dt – 1.5 A/ms minimum at 125°C
- Internally Isolated (2500 V_{RMS})
- These are Pb-Free Devices

Pin Out

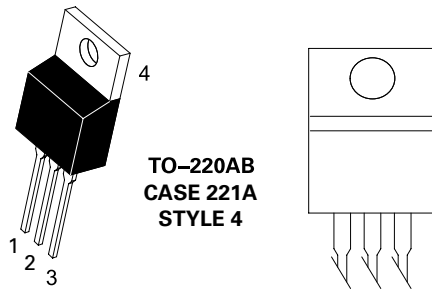

Functional Diagram

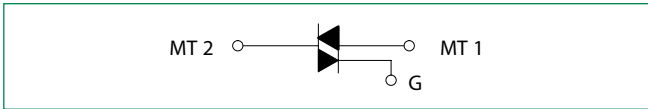

Additional Information



Datasheet



Resources



Samples

Maximum Ratings ($T_J = 25^\circ\text{C}$ unless otherwise noted)

Rating	Symbol	Value	Unit
Peak Repetitive Off-State Voltage (Note 1) (Gate Open, Sine Wave 50 to 60 Hz, $T_J = -40^\circ$ to 125°C)	BTA08–800CW3G V_{DRM}' V_{RRM}	800	V
On-State RMS Current (Full Cycle Sine Wave, 60 Hz, $T_C = 80^\circ\text{C}$)	$I_{T(RMS)}$	8.0	A
Peak Non-Repetitive Surge Current (One Full Cycle Sine Wave, 60 Hz, $T_C = 25^\circ\text{C}$)	I_{TSM}	90	A
Circuit Fusing Consideration ($t = 8.3$ ms)	I^2t	36	A ² sec
Non-Repetitive Surge Peak Off-State Voltage ($T_J = 25^\circ\text{C}$, $t = 10$ ms)	V_{DSM}'/V_{RSM}	$V_{DSM}'/V_{RSM} + 100$	V
Peak Gate Current ($T_J = 125^\circ\text{C}$, $t = 20$ ms)	I_{GM}	4.0	A
Peak Gate Power (Pulse Width ≤ 1.0 μs , $T_C = 80^\circ\text{C}$)	$P_{G(AV)}$	20	W
Average Gate Power ($T_J = 125^\circ\text{C}$)	$P_{G(AV)}$	1.0	W
Operating Junction Temperature Range	T_J	-40 to +125	$^\circ\text{C}$
Storage Temperature Range	T_{stg}	-40 to +125	$^\circ\text{C}$
RMS Isolation Voltage ($t = 300$ ms, R.H. $\leq 30\%$, $T_A = 25^\circ\text{C}$)	V_{iso}	2500	V

Stresses exceeding Maximum Ratings may damage the device. Maximum Ratings are stress ratings only. Functional operation above the Recommended Operating Conditions is not implied. Extended exposure to stresses above the Recommended Operating Conditions may affect device reliability.

- V_{DRM} and V_{RRM} for all types can be applied on a continuous basis. Ratings apply for zero or negative gate voltage; however, positive gate voltage shall not be applied concurrent with negative potential on the anode. Blocking voltages shall not be tested with a constant current source such that the voltage ratings of the devices are exceeded.

Thermal Characteristics

Rating	Symbol	Value	Unit
Thermal Resistance, Junction-to-Case (AC) Junction-to-Ambient	$R_{\theta JC}$ $R_{\theta JA}$	2.5 60	$^\circ\text{C}/\text{W}$
Maximum Lead Temperature for Soldering Purposes, 1/8" from case for 10 seconds	T_L	260	$^\circ\text{C}$

Electrical Characteristics - OFF ($T_J = 25^\circ\text{C}$ unless otherwise noted ; Electricals apply in both directions)

Characteristic	Symbol	Min	Typ	Max	Unit
Peak Repetitive Blocking Current ($V_D = V_{DRM} = V_{RRM}'$; Gate Open)	I_{DRM}' I_{RRM}	-	-	0.005	mA
		-	-	2.0	

Electrical Characteristics - ON ($T_J = 25^\circ\text{C}$ unless otherwise noted; Electricals apply in both directions)

Characteristic	Symbol	Min	Typ	Max	Unit
Forward On-State Voltage (Note 2) ($I_{TM} = \pm 22.5$ A Peak)	V_{TM}	-	-	1.55	V
Gate Trigger Current (Continuous dc) ($V_D = 12$ V, $R_L = 30$ Ω)	MT2(+), G(+)	2.5	-	35	mA
	MT2(+), G(-)	2.5	-	35	
	MT2(-), G(-)	2.5	-	35	
Holding Current ($V_D = 12$ V, Gate Open, Initiating Current = ± 150 mA)	I_H	-	-	35	mA
Latching Current ($V_D = 12$ V, $I_G = 50$ mA)	MT2(+), G(+)	-	-	50	mA
	MT2(+), G(-)	-	-	60	
	MT2(-), G(-)	-	-	50	
Gate Trigger Voltage ($V_D = 12$ V, $R_L = 30$ Ω)	MT2(+), G(+)	0.5	-	1.7	V
	MT2(+), G(-)	0.5	-	1.1	
	MT2(-), G(-)	0.5	-	1.1	
Gate Non-Trigger Voltage ($T_J = 125^\circ\text{C}$)	MT2(+), G(+)	0.2	-	-	V
	MT2(+), G(-)	0.2	-	-	
	MT2(-), G(-)	0.2	-	-	

2. Indicates Pulse Test: Pulse Width ≤ 2.0 ms, Duty Cycle $\leq 2\%$.

Dynamic Characteristics

Characteristic	Symbol	Min	Typ	Max	Unit
Rate of Change of Commutating Current, See Figure 10. (Gate Open, $T_j = 125^\circ\text{C}$, No Snubber)	$(di/dt)_c$	1.5	–	–	A/ms
Critical Rate of Rise of On-State Current ($T_j = 125^\circ\text{C}$, $f = 120\text{ Hz}$, $I_g = 2 \times I_{GT}$, $t_r \leq 100\text{ ns}$)	di/dt	–	–	50	A/ μs
Critical Rate of Rise of Off-State Voltage ($V_D = 0.66 \times V_{DRM}$, Exponential Waveform, Gate Open, $T_j = 125^\circ\text{C}$)	dV/dt	1500	–	–	V/ μs

Voltage Current Characteristic of SCR

Symbol	Parameter
V_{DRM}	Peak Repetitive Forward Off State Voltage
I_{DRM}	Peak Forward Blocking Current
V_{RRM}	Peak Repetitive Reverse Off State Voltage
I_{RRM}	Peak Reverse Blocking Current
V_{TM}	Maximum On State Voltage
I_H	Holding Current

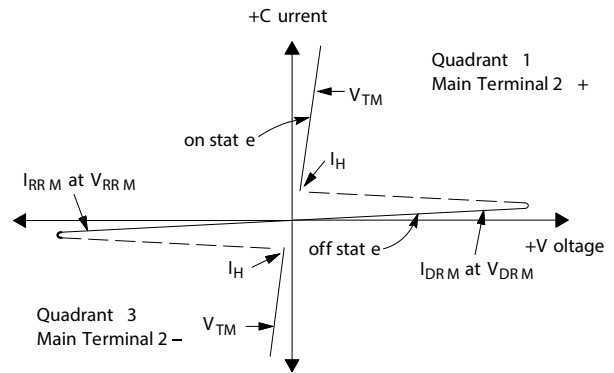

Quadrant Definitions for a Triac

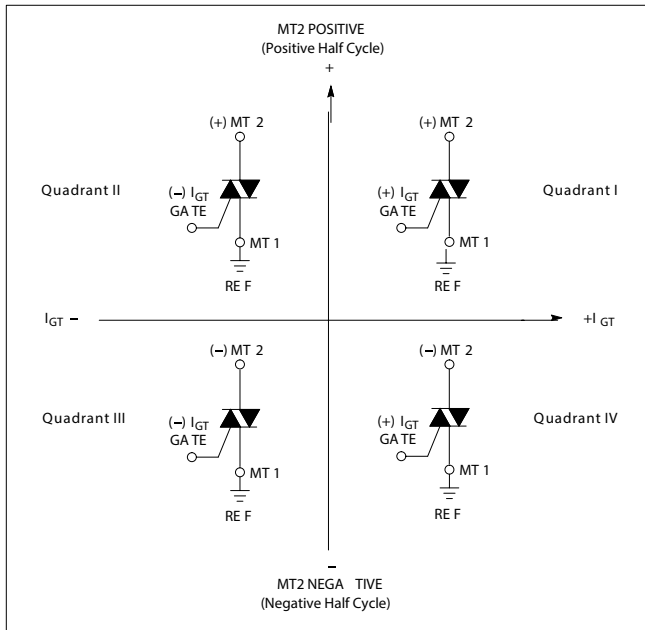

All polarities are referenced to MT1.
With in-phase signals (using standard AC lines) quadrants I and III are used

Figure 1. RMS Current Derating

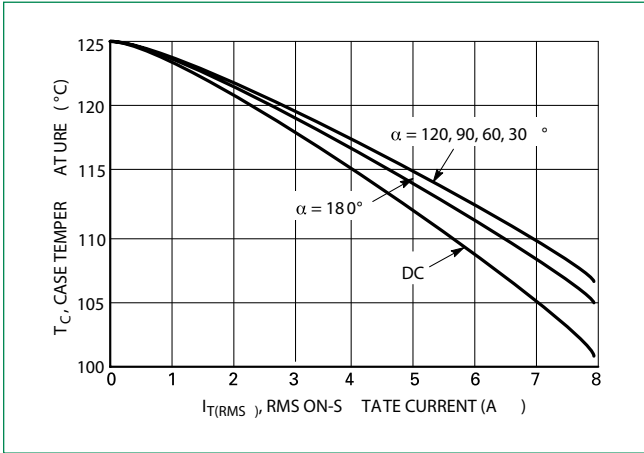

Figure 2. On-State Power Dissipation

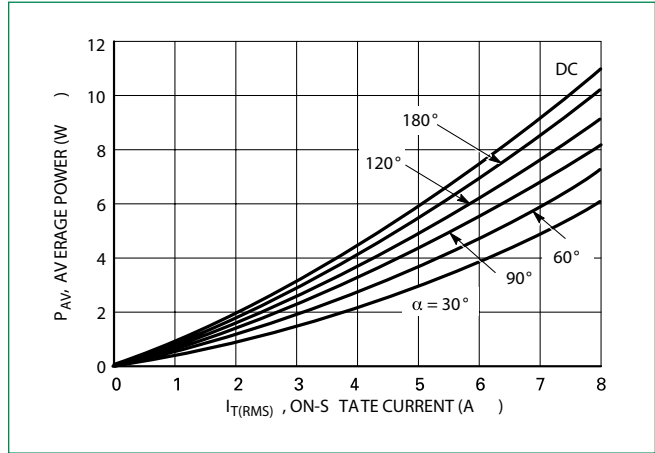

Figure 3. On-State Characteristics

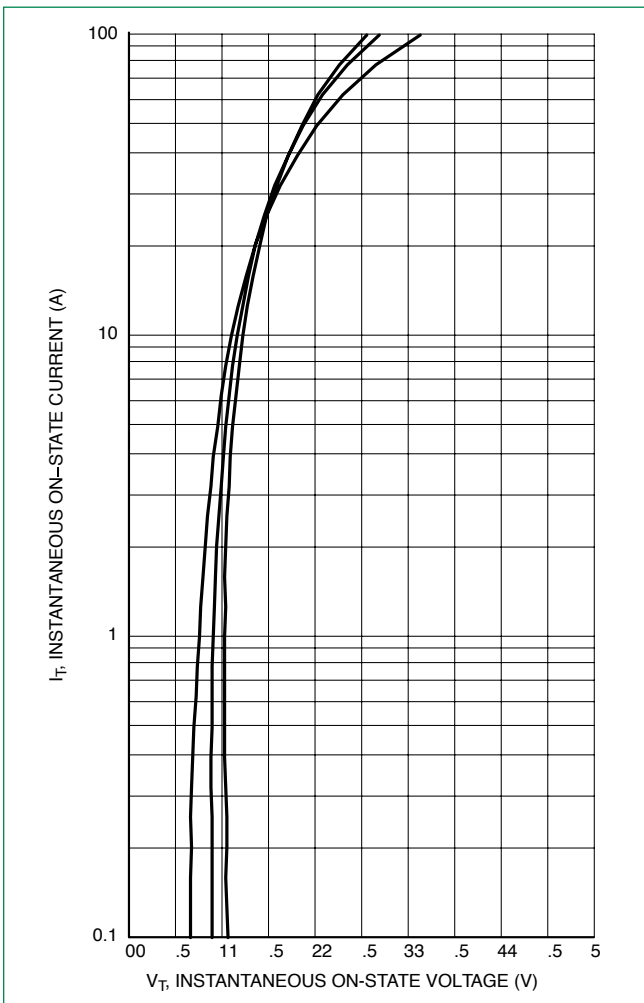

Figure 4. Thermal Response

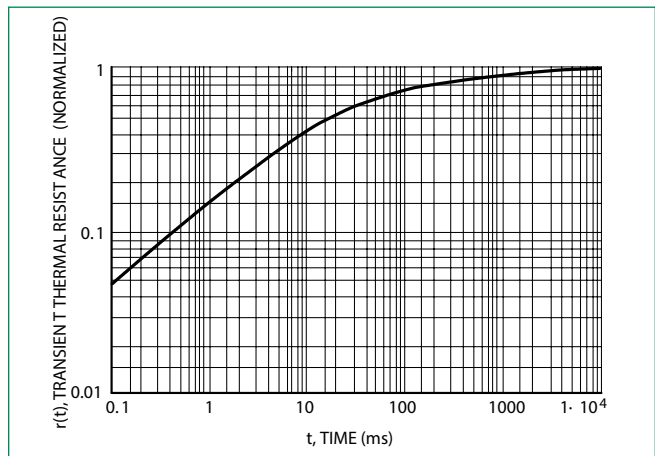

Figure 5. Hold Current Variation

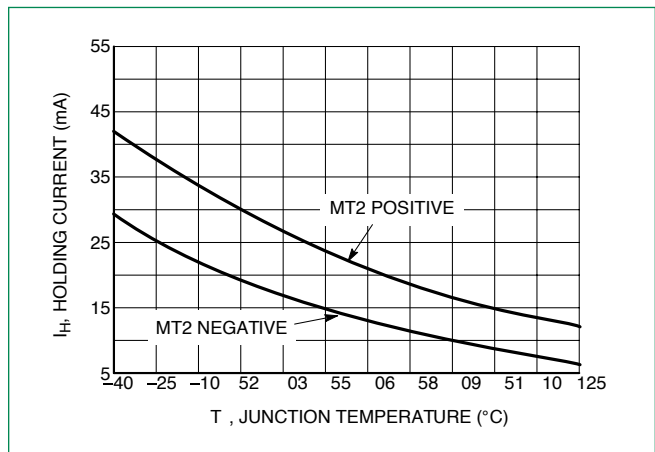

Figure 6. Gate Trigger Current Variation

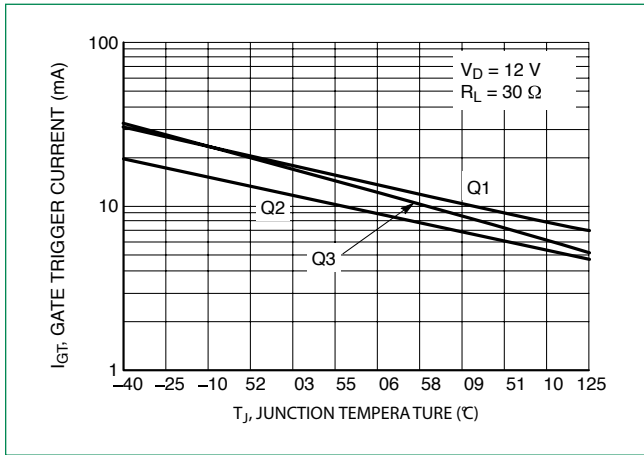

Figure 7. Gate Trigger Voltage Variation

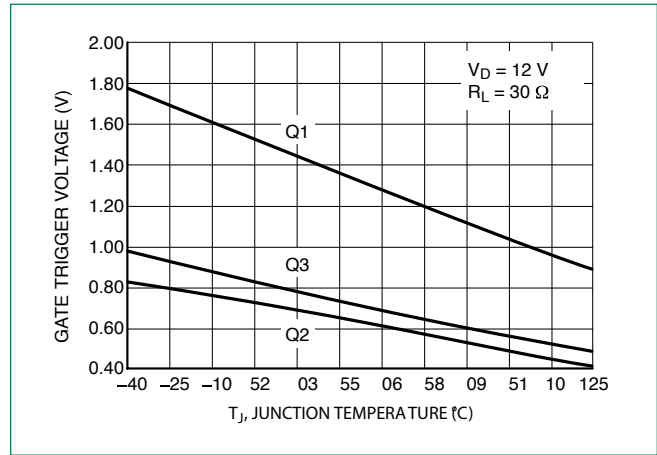

Figure 8. Critical Rate of Rise of Off-State Voltage (Exponential Waveform)

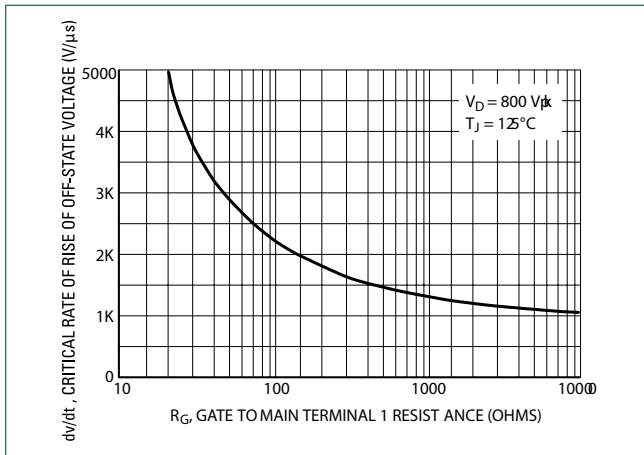

Figure 10. Latching Current Variation

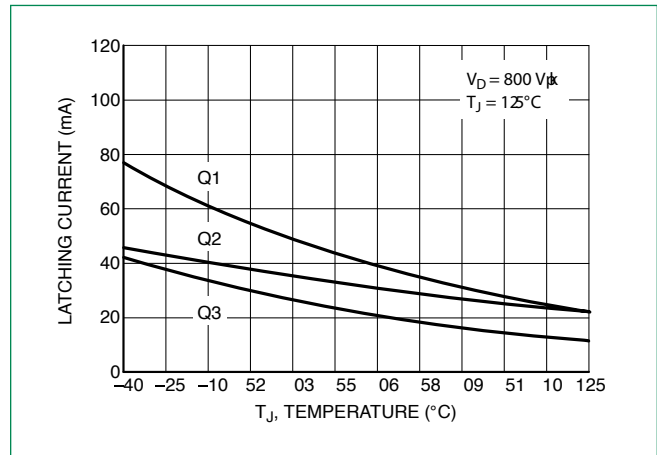
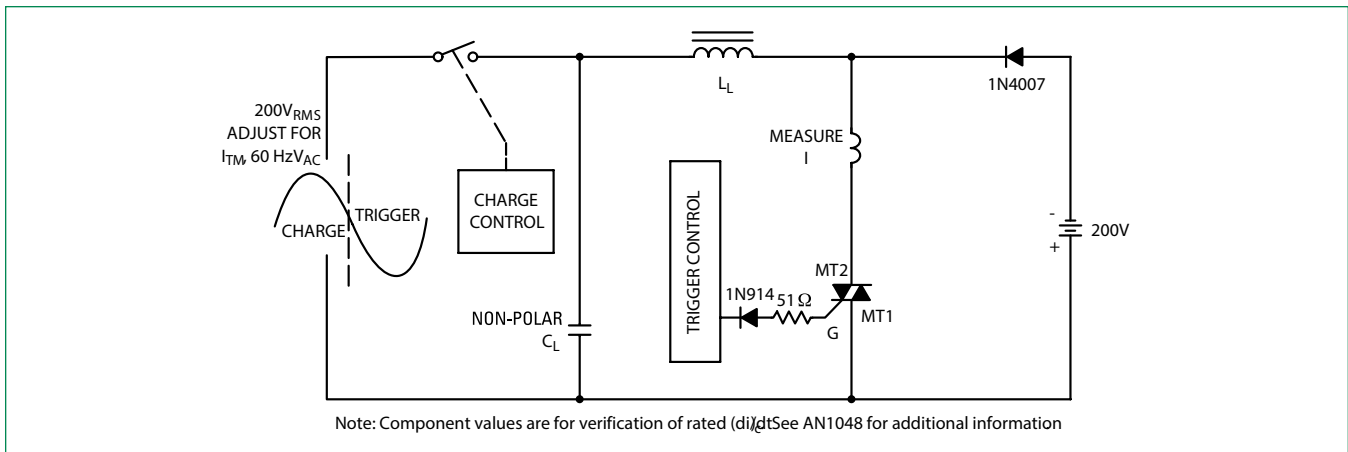
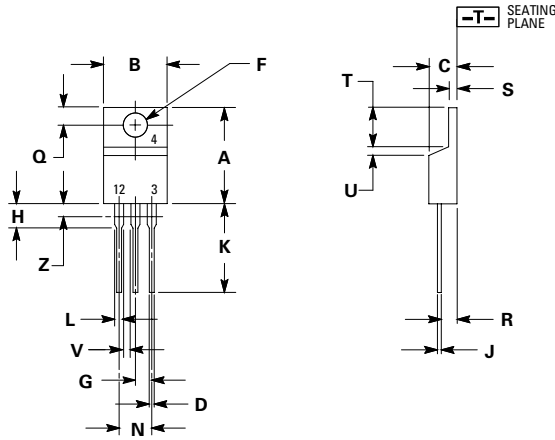

Figure 9. Simplified Test Circuit to Measure the Critical Rate of Rise of Commutating Current (di/dt)



Note: Component values are for verification of rated (di/dt). See AN1048 for additional information

Dimensions



Part Marking System

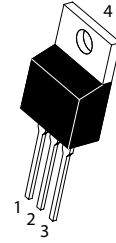

**TO-220AB
CASE 221A
STYLE 12**

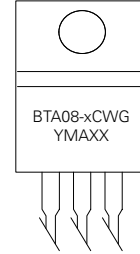

x =6 or 8
Y =Year
M =Month
A =Assembly Site
XX =Lot Serial Code
G =Pb-Free Package

Dim	Inches		Millimeters	
	Min	Max	Min	Max
A	0.590	0.620	14.99	15.75
B	0.380	0.420	9.65	10.67
C	0.178	0.188	4.52	4.78
D	0.025	0.035	0.64	0.89
F	0.142	0.147	3.61	3.73
G	0.095	0.105	2.41	2.67
H	0.110	0.130	2.79	3.30
J	0.018	0.024	0.46	0.61
K	0.540	0.575	13.72	14.61
L	0.060	0.075	1.52	1.91
N	0.195	0.205	4.95	5.21
Q	0.105	0.115	2.67	2.92
R	0.085	0.095	2.16	2.41
S	0.045	0.060	1.14	1.52
T	0.235	0.255	5.97	6.47
U	0.000	0.050	0.00	1.27
V	0.045	---	1.15	---
Z	---	0.080	---	2.04

Pin Assignment	
1	Main Terminal 1
2	Main Terminal 2
3	Gate
4	No Connection

Ordering Information

Device	Package	Shipping
BTA08-800CW3G	TO-220AB (Pb-Free)	500 Units / Rail

1. DIMENSIONING AND TOLERANCING PER ANSI Y14.5M, 1982.
2. CONTROLLING DIMENSION: INCH.
3. DIMENSION Z DEFINES A ZONE WHERE ALL BODY AND LEAD IRREGULARITIES ARE ALLOWED.

Disclaimer Notice - Information furnished is believed to be accurate and reliable. However, users should independently evaluate the suitability of and test each product selected for their own applications. Littelfuse products are not designed for, and may not be used in, all applications. Read complete Disclaimer Notice at <http://www.littelfuse.com/disclaimer-electronics>.